

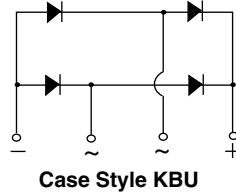

## Single-Phase Bridge Rectifier

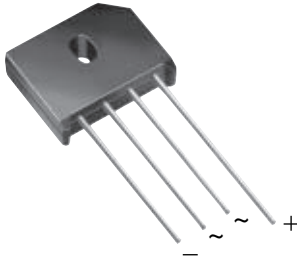

Case Style KBU

### FEATURES

- UL recognition, file number E54214
- Ideal for printed circuit boards
- High surge current capability
- Plastic-passivated junction
- High case dielectric strength of 1500 V<sub>RMS</sub>
- Solder dip 275 °C max. 10 s, per JESD 22-B106
- Material categorization: for definitions of compliance please see [www.vishay.com/doc?99912](http://www.vishay.com/doc?99912)



RoHS COMPLIANT

### LINKS TO ADDITIONAL RESOURCES



### TYPICAL APPLICATIONS

General purpose use in AC/DC bridge full wave rectification for monitor, TV, printer, SMPS, adapter, audio equipment, and home appliances applications.

### MECHANICAL DATA

Case: KBU

Molding compound meets UL 94 V-0 flammability rating Base P/N-E4 - RoHS-compliant, commercial grade

**Terminals:** silver plated leads, solderable per J-STD-002 and JESD22-B102

**Polarity:** as marked on body

**Mounting Torque:** 10 cm·kg (8.8 inches·lbs) max.

**Recommended Torque:** 5.7 cm·kg (5 inches·lbs)

PRIMARY CHARACTERISTICS	
Package	KBU
I <sub>F(AV)</sub>	6 A
V <sub>RRM</sub>	50 V, 100 V, 200 V, 400 V, 600 V, 800 V, 1000 V
I <sub>FSM</sub>	200 A
I <sub>R</sub>	5 μA
V <sub>F</sub> at I <sub>F</sub> = 6 A	1.0 V
T <sub>J</sub> max.	150 °C
Circuit configurations	In-line

MAXIMUM RATINGS (T <sub>A</sub> = 25 °C unless otherwise noted)										
PARAMETER	SYMBOL	KBU6A	KBU6B	KBU6D	KBU6G	KBU6J	KBU6K	KBU6M	UNIT	
Maximum repetitive peak reverse voltage	V <sub>RRM</sub>	50	100	200	400	600	800	1000	V	
Maximum RMS voltage	V <sub>RMS</sub>	35	70	140	280	420	560	700	V	
Maximum DC blocking voltage	V <sub>DC</sub>	50	100	200	400	600	800	1000	V	
Maximum average forward rectified output current at	I <sub>F(AV)</sub>	T <sub>C</sub> = 100 °C (1)(3)							6.0	A
		T <sub>A</sub> = 40 °C (2)							6.0	
Peak forward surge current single sine-wave superimposed on rated load	I <sub>FSM</sub>	250							A	
Operating junction and storage temperature range	T <sub>J</sub> , T <sub>STG</sub>	-50 to +150							°C	

### Notes

- (1) Recommended mounted position is to bolt down on heatsink with silicone thermal compound for maximum heat transfer with #6 screw
- (2) Thermal resistance from junction to ambient with units in free air, PCB mounted on 0.5" x 0.5" (12 mm x 12 mm) copper pads, 0.375" (9.5 mm) lead length
- (3) Thermal resistance from junction to case with units mounted on a 2.6" x 1.4" x 0.06" thick (6.5 cm x 3.5 cm x 0.15 cm) aluminum plate

ELECTRICAL CHARACTERISTICS (T <sub>A</sub> = 25 °C unless otherwise noted)										
PARAMETER	TEST CONDITIONS	SYMBOL	KBU6A	KBU6B	KBU6D	KBU6G	KBU6J	KBU6K	KBU6M	UNIT
Maximum instantaneous forward drop per diode	I <sub>F</sub> = 6.0 A	V <sub>F</sub>					1.0			V
Maximum DC reverse current at rated DC blocking voltage per diode	T <sub>A</sub> = 25 °C	I <sub>R</sub>					5.0			μA
	T <sub>A</sub> = 125 °C						1.0			mA



<b>THERMAL CHARACTERISTICS</b> ( $T_A = 25\text{ }^\circ\text{C}$ unless otherwise noted)										
PARAMETER	SYMBOL	KBU6A	KBU6B	KBU6D	KBU6G	KBU6J	KBU6K	KBU6M	UNIT	
Typical thermal resistance	$R_{\theta JA}$ <sup>(1)</sup>					8.6				°C/W
	$R_{\theta JC}$ <sup>(2)</sup>					3.1				

**Notes**

- (1) Thermal resistance from junction to ambient with units in free air, PCB mounted on 0.5" x 0.5" (12 mm x 12 mm) copper pads, 0.375" (9.5 mm) lead length
- (2) Thermal resistance from junction to case with units mounted on a 2.6" x 1.4" x 0.06" thick (6.5 cm x 3.5 cm x 0.15 cm) Al. plate

<b>ORDERING INFORMATION</b> (Example)				
PREFERRED P/N	UNIT WEIGHT (g)	PREFERRED PACKAGE CODE	BASE QUANTITY	DELIVERY MODE
KBU6J-E4/51	8.0	51	250	Anti-static PVC tray

**RATINGS AND CHARACTERISTICS CURVES** ( $T_A = 25\text{ }^\circ\text{C}$  unless otherwise noted)

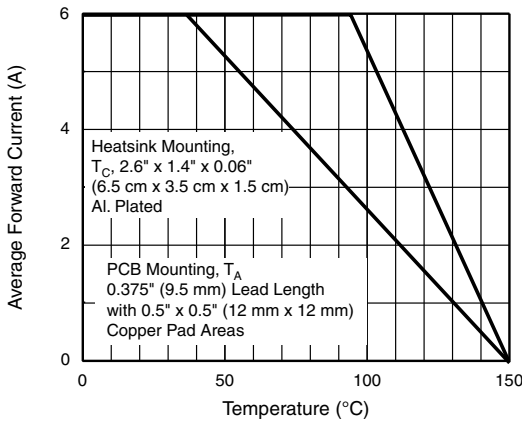

Fig. 1 - Derating Curve Output Rectified Current

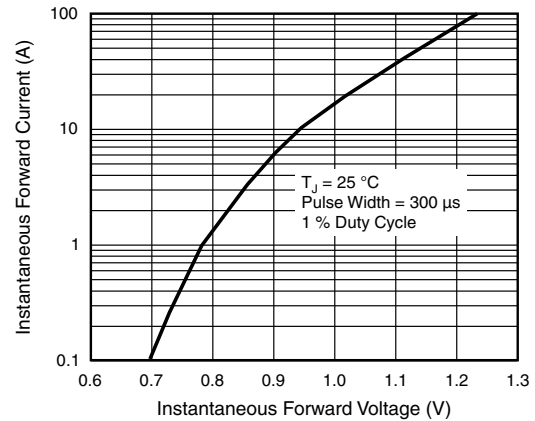

Fig. 3 - Typical Instantaneous Forward Characteristics Per Diode

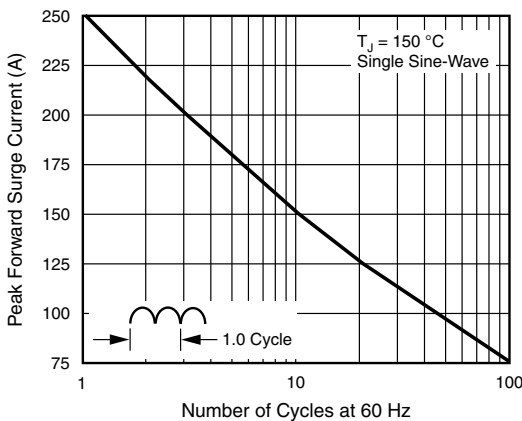

Fig. 2 - Maximum Non-Repetitive Peak Forward Surge Current Per Diode

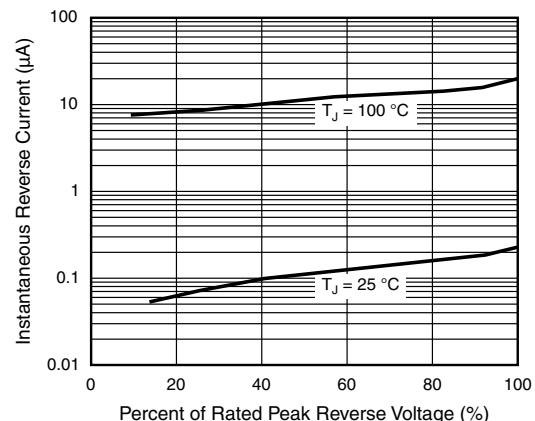

Fig. 4 - Typical Reverse Leakage Characteristics Per Diode

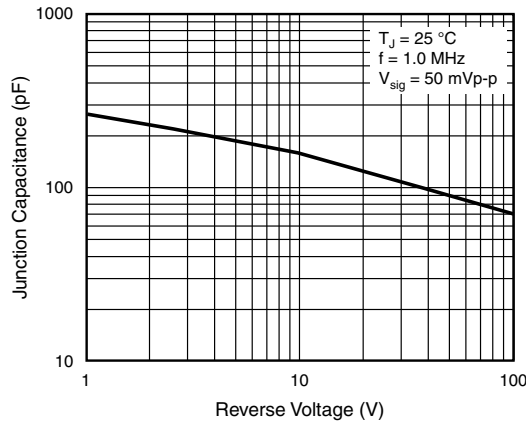
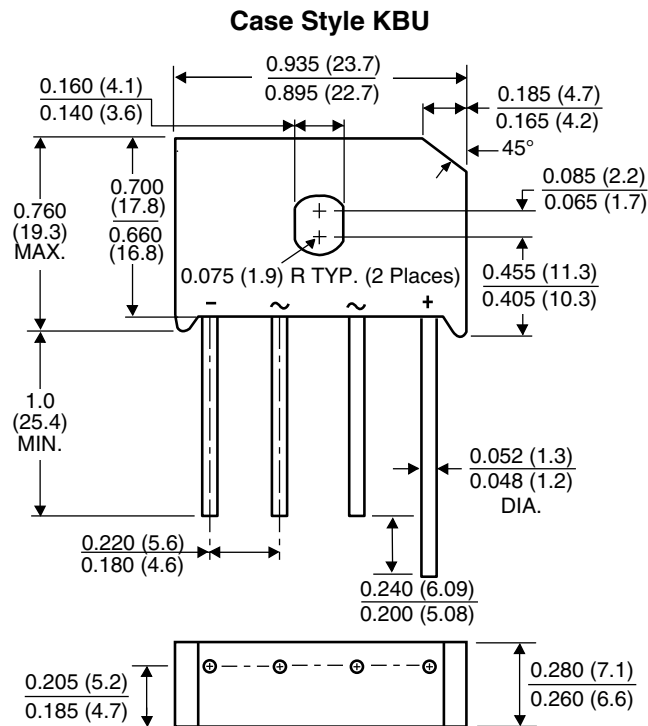

Fig. 5 - Typical Junction Capacitance Per Diode

**PACKAGE OUTLINE DIMENSIONS** in inches (millimeters)





## Disclaimer

ALL PRODUCT, PRODUCT SPECIFICATIONS AND DATA ARE SUBJECT TO CHANGE WITHOUT NOTICE TO IMPROVE RELIABILITY, FUNCTION OR DESIGN OR OTHERWISE.

Vishay Intertechnology, Inc., its affiliates, agents, and employees, and all persons acting on its or their behalf (collectively, "Vishay"), disclaim any and all liability for any errors, inaccuracies or incompleteness contained in any datasheet or in any other disclosure relating to any product.

Vishay makes no warranty, representation or guarantee regarding the suitability of the products for any particular purpose or the continuing production of any product. To the maximum extent permitted by applicable law, Vishay disclaims (i) any and all liability arising out of the application or use of any product, (ii) any and all liability, including without limitation special, consequential or incidental damages, and (iii) any and all implied warranties, including warranties of fitness for particular purpose, non-infringement and merchantability.

Statements regarding the suitability of products for certain types of applications are based on Vishay's knowledge of typical requirements that are often placed on Vishay products in generic applications. Such statements are not binding statements about the suitability of products for a particular application. It is the customer's responsibility to validate that a particular product with the properties described in the product specification is suitable for use in a particular application. Parameters provided in datasheets and / or specifications may vary in different applications and performance may vary over time. All operating parameters, including typical parameters, must be validated for each customer application by the customer's technical experts. Product specifications do not expand or otherwise modify Vishay's terms and conditions of purchase, including but not limited to the warranty expressed therein.

Hyperlinks included in this datasheet may direct users to third-party websites. These links are provided as a convenience and for informational purposes only. Inclusion of these hyperlinks does not constitute an endorsement or an approval by Vishay of any of the products, services or opinions of the corporation, organization or individual associated with the third-party website. Vishay disclaims any and all liability and bears no responsibility for the accuracy, legality or content of the third-party website or for that of subsequent links.

Except as expressly indicated in writing, Vishay products are not designed for use in medical, life-saving, or life-sustaining applications or for any other application in which the failure of the Vishay product could result in personal injury or death. Customers using or selling Vishay products not expressly indicated for use in such applications do so at their own risk. Please contact authorized Vishay personnel to obtain written terms and conditions regarding products designed for such applications.

No license, express or implied, by estoppel or otherwise, to any intellectual property rights is granted by this document or by any conduct of Vishay. Product names and markings noted herein may be trademarks of their respective owners.