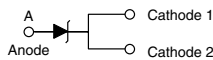

Surface Mount PAR[®] Transient Voltage Suppressors

Unidirectional 1500 W TVS in SMPC (TO-277) Package

TO-277A (SMPC)

LINKS TO ADDITIONAL RESOURCES

PRIMARY CHARACTERISTICS	
V_{WM}	5.8 V to 43.6 V
V_{BR}	6.8 V to 51 V
P_{PPM}	1500 W
T_J max.	185 °C
Polarity	Unidirectional
Package	SMPC (TO-277A)

FEATURES

- Junction passivation optimized design passivated anisotropic rectifier technology
- $T_J = 185$ °C capability suitable for high reliability and automotive requirement
- Very low profile - typical height of 1.1 mm
- Ideal for automated placement
- Unidirection only
- Excellent clamping capability
- Low incremental surge resistance
- Very fast response time
- Meets MSL level 1, per J-STD-020
- AEC-Q101 qualified
- Material categorization: for definitions of compliance please see www.vishay.com/doc?99912

 AUTOMOTIVE
GRADE
Available

RoHS
COMPLIANT
HALOGEN
FREE
TYPICAL APPLICATIONS

Use in sensitive electronics protection against voltage transients induced by inductive load switching and lighting on ICs, MOSFET, signal lines of sensor units for consumer, computer, industrial, automotive, and telecommunication.

MECHANICAL DATA
Case: SMPC (TO-277A)

Molding compound meets UL 94 V-0 flammability rating Base P/NHM3_X - halogen-free, RoHS-compliant, and AEC-Q101 qualified ("X" denotes revision code e.g. A, B, ...)

Terminals: matte tin plated leads, solderable per J-STD-002 and JESD 22-B102

HM3 suffix meets JESD 201 class 2 whisker test

MAXIMUM RATINGS ($T_A = 25$ °C, unless otherwise noted)			
PARAMETER	SYMBOL	VALUE	UNIT
Peak power dissipation with a 10/1000 μ s waveform (fig. 3) ⁽¹⁾⁽²⁾	P_{PPM}	1500	W
Peak power pulse current with a 10/1000 μ s waveform (fig. 1) ⁽¹⁾	I_{PPM}	See next table	A
Peak forward surge current 8.3 ms single half sine-wave ⁽²⁾	I_{FSM}	200	A
Maximum instantaneous forward voltage at 100 A ⁽³⁾	V_F	3.5	V
Operating junction and storage temperature range	T_J, T_{STG}	-65 to +185	°C

Notes

⁽¹⁾ Non-repetitive current pulse, per fig. 3 and derated above $T_A = 25$ °C per fig. 2

⁽²⁾ Measured on 8.3 ms single half sine-wave, or equivalent square wave, duty cycle = 4 pulses per minute maximum

⁽³⁾ Pulse test: 300 μ s pulse width, 1 % duty cycle



ELECTRICAL CHARACTERISTICS ($T_A = 25\text{ }^\circ\text{C}$, unless otherwise noted)											
DEVICE TYPE	DEVICE MARKING CODE	BREAKDOWN VOLTAGE $V_{BR}^{(1)}$ AT I_T (V)			TEST CURRENT I_T (mA)	STAND-OFF VOLTAGE V_{WM} (V)	MAXIMUM REVERSE LEAKAGE AT V_{WM} I_R (μA)	MAXIMUM REVERSE LEAKAGE AT V_{WM} $T_J = 150\text{ }^\circ\text{C}$ I_D (μA)	MAXIMUM PEAK PULSE SURGE CURRENT $I_{PPM}^{(2)}$ (A)	MAXIMUM CLAMPING VOLTAGE AT I_{PPM} V_C (V)	TYPICAL TEMP. COEFFICIENT OF $V_{BR}^{(3)}$ αT (%/ $^\circ\text{C}$)
		MIN.	NOM.	MAX.							
TPC6.8A	DEP	6.45	6.80	7.14	10	5.80	1500	10 000	143	10.5	0.047
TPC7.5A	DGP	7.13	7.50	7.88	10	6.40	500	5000	133	11.3	0.052
TPC8.2A	DKP	7.79	8.20	8.61	10	7.02	200	2000	124	12.1	0.056
TPC9.1A	DMP	8.65	9.10	9.55	1.0	7.78	50	500	112	13.4	0.060
TPC10A	DPP	9.5	10.0	10.5	1.0	8.55	20	200	103	14.5	0.064
TPC11A	DRP	10.5	11.0	11.6	1.0	9.40	5.0	50	96.2	15.6	0.067
TPC12A	DTP	11.4	12.0	12.6	1.0	10.2	2.0	10	89.8	16.7	0.070
TPC13A	DVP	12.4	13.0	13.7	1.0	11.1	2.0	10	82.4	18.2	0.072
TPC15A	DXP	14.3	15.0	15.8	1.0	12.8	1.0	10	70.8	21.2	0.076
TPC16A	DZP	15.2	16.0	16.8	1.0	13.6	1.0	10	66.7	22.5	0.078
TPC18A	EEP	17.1	18.0	18.9	1.0	15.3	1.0	10	59.5	25.2	0.080
TPC20A	EGP	19.0	20.0	21.0	1.0	17.1	1.0	10	54.2	27.7	0.082
TPC22A	EKP	20.9	22.0	23.1	1.0	18.8	1.0	10	49.0	30.6	0.084
TPC24A	EMP	22.8	24.0	25.2	1.0	20.5	1.0	10	45.2	33.2	0.085
TPC27A	EPP	25.7	27.0	28.4	1.0	23.1	1.0	10	40.0	37.5	0.087
TPC30A	ERP	28.5	30.0	31.5	1.0	25.6	1.0	10	36.2	41.4	0.088
TPC33A	ETP	31.4	33.0	34.7	1.0	28.2	1.0	10	32.8	45.7	0.089
TPC36A	EVP	34.2	36.0	37.8	1.0	30.8	1.0	15	30.1	49.9	0.090
TPC39A	EXP	37.1	39.0	41.0	1.0	33.3	1.0	15	27.8	53.9	0.091
TPC43A	EZP	40.9	43.0	45.2	1.0	36.8	1.0	20	25.3	59.3	0.092
TPC47A	FEP	44.7	47.0	49.4	1.0	40.2	1.0	20	23.1	64.8	0.092
TPC51A	FGP	48.5	51.0	53.6	1.0	43.6	1.0	20	21.4	70.1	0.093

Notes

- (1) V_{BR} measured after I_T applied for 300 μs , I_T = square wave pulse or equivalent
- (2) Surge current waveform per fig. 3 and derated per fig. 2
- (3) To calculate V_{BR} vs. junction temperature, use the following formula: V_{BR} at $T_J = V_{BR}$ at $25\text{ }^\circ\text{C} \times (1 + \alpha T \times (T_J - 25))$
- (4) All terms and symbols are consistent with ANSI/IEEE C62.35

ORDERING INFORMATION (Example)				
PREFERRED P/N	UNIT WEIGHT (g)	PREFERRED PACKAGE CODE	BASE QUANTITY	DELIVERY MODE
TPC10AHM3_A/H ⁽¹⁾	0.10	H	1500	7" diameter plastic tape and reel
TPC10AHM3_A/I ⁽¹⁾	0.10	I	6500	13" diameter plastic tape and reel

Note

- (1) Automotive grade



RATINGS AND CHARACTERISTICS CURVES ($T_A = 25\text{ }^\circ\text{C}$, unless otherwise noted)

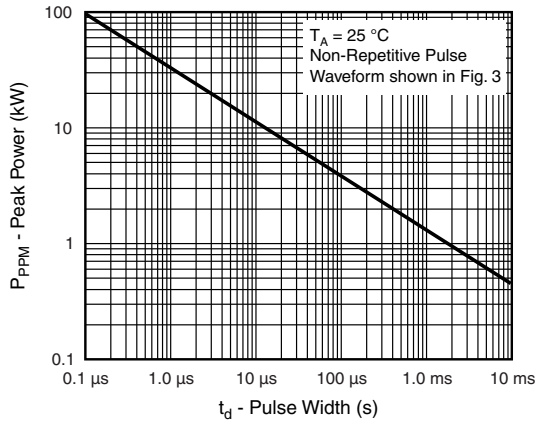

Fig. 1 - Peak Pulse Power Rating Curve

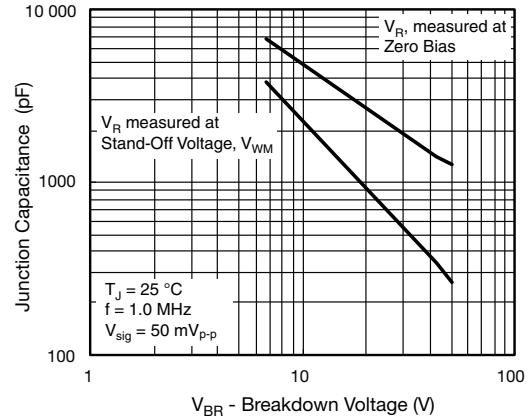

Fig. 4 - Typical Junction Capacitance

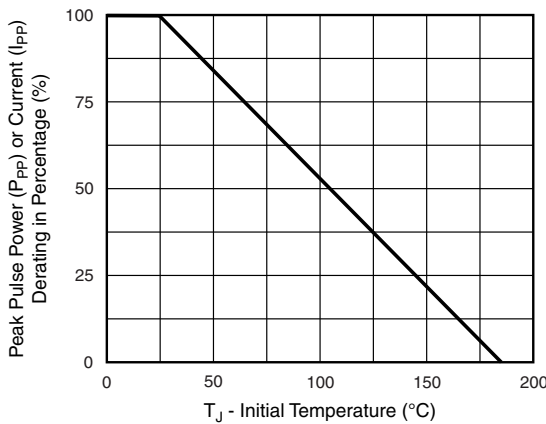

Fig. 2 - Pulse Power or Current vs. Initial Junction Temperature

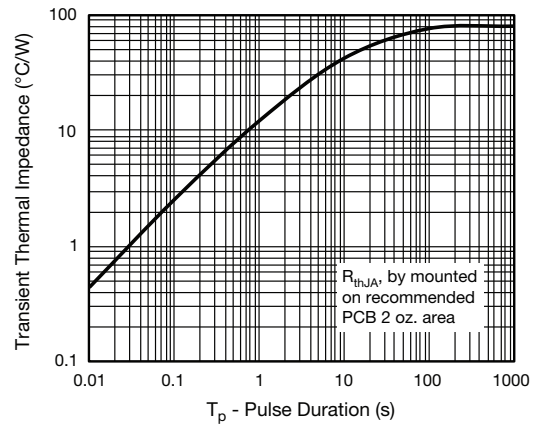

Fig. 5 - Typical Transient Thermal Impedance

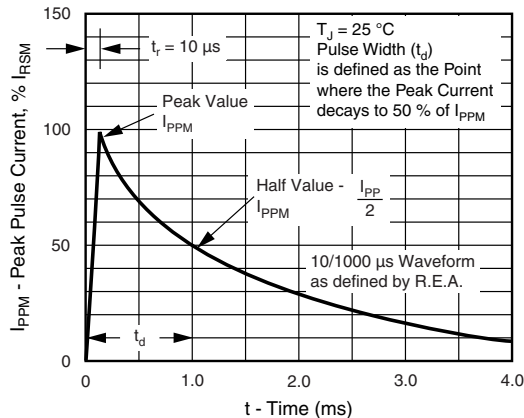
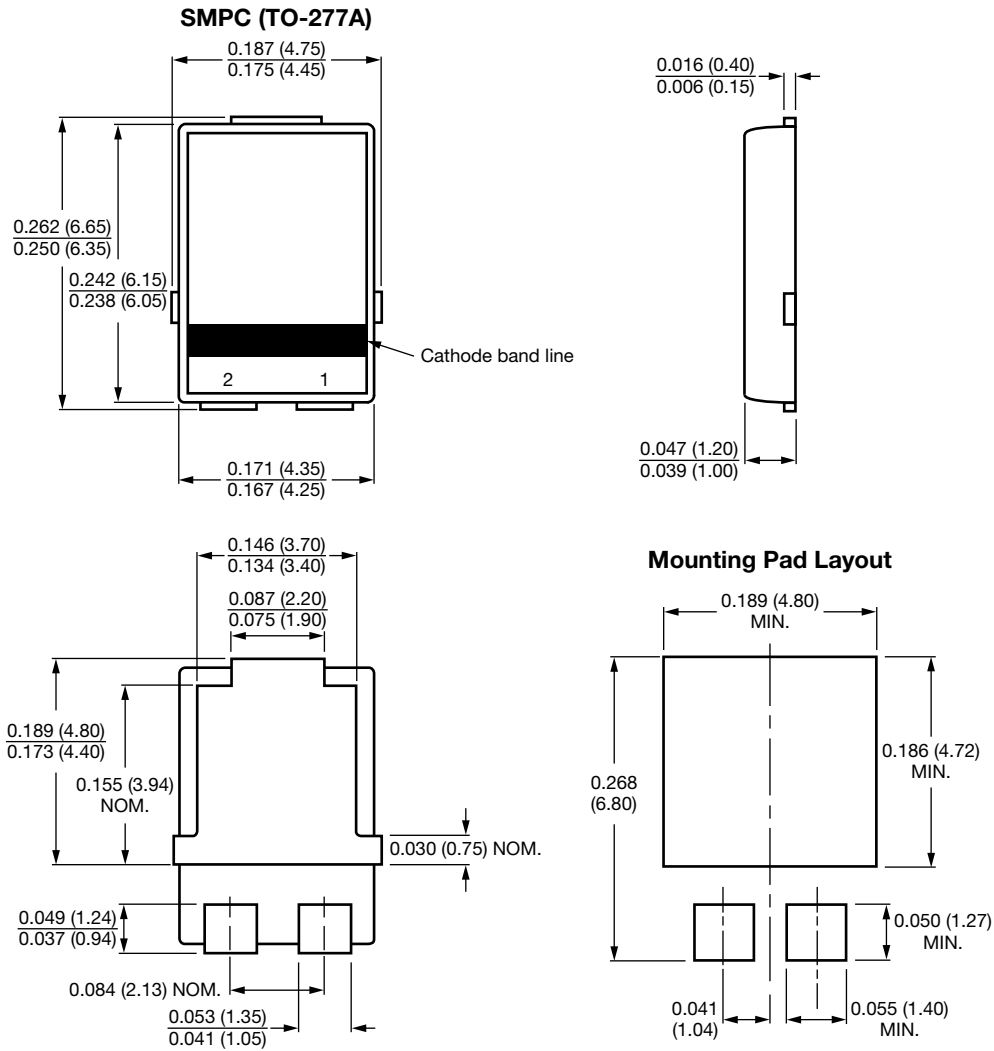

Fig. 3 - Pulse Waveform



PACKAGE OUTLINE DIMENSIONS in inches (millimeters)





Disclaimer

ALL PRODUCT, PRODUCT SPECIFICATIONS AND DATA ARE SUBJECT TO CHANGE WITHOUT NOTICE TO IMPROVE RELIABILITY, FUNCTION OR DESIGN OR OTHERWISE.

Vishay Intertechnology, Inc., its affiliates, agents, and employees, and all persons acting on its or their behalf (collectively, "Vishay"), disclaim any and all liability for any errors, inaccuracies or incompleteness contained in any datasheet or in any other disclosure relating to any product.

Vishay makes no warranty, representation or guarantee regarding the suitability of the products for any particular purpose or the continuing production of any product. To the maximum extent permitted by applicable law, Vishay disclaims (i) any and all liability arising out of the application or use of any product, (ii) any and all liability, including without limitation special, consequential or incidental damages, and (iii) any and all implied warranties, including warranties of fitness for particular purpose, non-infringement and merchantability.

Statements regarding the suitability of products for certain types of applications are based on Vishay's knowledge of typical requirements that are often placed on Vishay products in generic applications. Such statements are not binding statements about the suitability of products for a particular application. It is the customer's responsibility to validate that a particular product with the properties described in the product specification is suitable for use in a particular application. Parameters provided in datasheets and / or specifications may vary in different applications and performance may vary over time. All operating parameters, including typical parameters, must be validated for each customer application by the customer's technical experts. Product specifications do not expand or otherwise modify Vishay's terms and conditions of purchase, including but not limited to the warranty expressed therein.

Hyperlinks included in this datasheet may direct users to third-party websites. These links are provided as a convenience and for informational purposes only. Inclusion of these hyperlinks does not constitute an endorsement or an approval by Vishay of any of the products, services or opinions of the corporation, organization or individual associated with the third-party website. Vishay disclaims any and all liability and bears no responsibility for the accuracy, legality or content of the third-party website or for that of subsequent links.

Except as expressly indicated in writing, Vishay products are not designed for use in medical, life-saving, or life-sustaining applications or for any other application in which the failure of the Vishay product could result in personal injury or death. Customers using or selling Vishay products not expressly indicated for use in such applications do so at their own risk. Please contact authorized Vishay personnel to obtain written terms and conditions regarding products designed for such applications.

No license, express or implied, by estoppel or otherwise, to any intellectual property rights is granted by this document or by any conduct of Vishay. Product names and markings noted herein may be trademarks of their respective owners.