



## Medium Power Silicon Rectifier Diodes, (Stud Version), 12 A



DO-4 (DO-203AA)

### FEATURES

- Voltage ratings from 50 V to 1000 V
- High surge capability
- Low thermal impedance
- High temperature rating
- Can be supplied as JAN and JAN-TX devices in accordance with MIL-S-19500/260
- Material categorization: for definitions of compliance please see [www.vishay.com/doc?99912](http://www.vishay.com/doc?99912)



RoHS COMPLIANT

PRIMARY CHARACTERISTICS	
$I_{F(AV)}$	12 A
Package	DO-4 (DO-203AA)
Circuit configuration	Single

MAJOR RATINGS AND CHARACTERISTICS			
PARAMETER	TEST CONDITIONS	VALUES	UNITS
$I_{F(AV)}$		<b>12</b>	A
	$T_C$	<b>150</b>	°C
$I_{FSM}$	50 Hz	230	A
	60 Hz	<b>240</b>	
$I^2t$	50 Hz	260	A <sup>2</sup> s
	60 Hz	240	
$T_J$		-65 to +200	°C
$V_{RRM}$	Range	<b>50 to 1000</b>	V

### Note

- JEDEC® registered values are in bold

### ELECTRICAL SPECIFICATIONS

VOLTAGE RATINGS				
TYPE NUMBER	$V_{RRM}$ , MAXIMUM REPETITIVE PEAK REVERSE VOLTAGE ( $T_C = -65\text{ °C TO }200\text{ °C}$ ) V	$V_{R(RMS)}$ , MAXIMUM RMS REVERSE VOLTAGE ( $T_C = -65\text{ °C TO }200\text{ °C}$ ) V	$V_{RSM}$ , MAXIMUM NON-REPETITIVE PEAK REVERSE VOLTAGE ( $T_C = -65\text{ °C TO }200\text{ °C}$ ) V	$V_{RM}$ , MAXIMUM DIRECT REVERSE VOLTAGE ( $T_C = -65\text{ °C TO }200\text{ °C}$ ) V
VS-1N1199A	<b>50</b>	<b>35</b>	<b>100</b>	<b>50</b>
VS-1N1200A	<b>100</b>	<b>70</b>	<b>200</b>	<b>100</b>
VS-1N1201A	<b>150</b>	<b>105</b>	<b>300</b>	<b>150</b>
VS-1N1202A	<b>200</b>	<b>140</b>	<b>350</b>	<b>200</b>
VS-1N1203A	<b>300</b>	<b>210</b>	<b>450</b>	<b>300</b>
VS-1N1204A	<b>400</b>	<b>280</b>	<b>600</b>	<b>400</b>
VS-1N1205A	<b>500</b>	<b>350</b>	<b>700</b>	<b>500</b>
VS-1N1206A	<b>600</b>	<b>420</b>	<b>800</b>	<b>600</b>
VS-1N3670A	<b>700</b>	490	<b>900</b>	<b>700</b>
VS-1N3671A	<b>800</b>	560	<b>1000</b>	<b>800</b>
VS-1N3672A	<b>900</b>	630	<b>1100</b>	<b>900</b>
VS-1N3673A	<b>1000</b>	700	<b>1200</b>	<b>1000</b>
VS-1N3624	<b>1000</b>	1200	<b>1400</b>	<b>1000</b>

### Notes

- JEDEC® registered values are in bold
- Basic part number indicates cathode to case; for anode to case, add "R" to part number, e.g., 1N1199RA



FORWARD CONDUCTION						
PARAMETER	SYMBOL	TEST CONDITIONS		VALUES	UNITS	
Maximum average forward current at case temperature	$I_{F(AV)}$	180° sinusoidal conduction		<b>12</b>	A	
				<b>150</b>	°C	
Maximum peak one cycle non-repetitive surge current	$I_{FSM}$	Half cycle 50 Hz sine wave or 6 ms rectangular pulse	Following any rated load condition and with rated $V_{RRM}$ applied	230	A	
		Half cycle 60 Hz sine wave or 5 ms rectangular pulse		<b>240</b>		
		Half cycle 50 Hz sine wave or 6 ms rectangular pulse	Following any rated load condition and with $V_{RRM}$ applied following surge = 0 V	275		
		Half cycle 60 Hz sine wave or 5 ms rectangular pulse		285		
Maximum $I^2t$ for fusing	$I^2t$	t = 10 ms	With rated $V_{RRM}$ applied following surge, initial $T_J = 200\text{ °C}$	260	A <sup>2</sup> s	
		t = 8.3 ms		240		
Maximum $I^2t$ for individual device fusing		t = 10 ms	With $V_{RRM} = 0\text{ V}$ following surge, initial $T_J = 200\text{ °C}$	370		
		t = 8.3 ms		340		
Maximum $I^2\sqrt{t}$ for individual device fusing	$I^2\sqrt{t}$ (1)	t = 0.1 ms to 10 ms, $V_{RRM} = 0\text{ V}$ following surge		3715	A <sup>2</sup> √s	
Maximum forward voltage drop	$V_{FM}$	$I_{F(AV)} = 12\text{ A}$ (38 A peak), $T_C = 25\text{ °C}$		<b>1.35</b>	V	
Maximum average reverse current	$I_{R(AV)}$ (2)	Maximum rated $I_{F(AV)}$ and $T_C$		$V_{RRM} = 50\text{ V}$	mA	
				$V_{RRM} = 100\text{ V}$		<b>3.0</b>
				$V_{RRM} = 150\text{ V}$		<b>2.5</b>
				$V_{RRM} = 200\text{ V}$		<b>2.25</b>
				$V_{RRM} = 300\text{ V}$		<b>2.0</b>
				$V_{RRM} = 400\text{ V}$		<b>1.75</b>
				$V_{RRM} = 500\text{ V}$		<b>1.5</b>
				$V_{RRM} = 600\text{ V}$		<b>1.25</b>
				$V_{RRM} = 700\text{ V}$		<b>1.0</b>
				$V_{RRM} = 800\text{ V}$		<b>0.9</b>
				$V_{RRM} = 900\text{ V}$		<b>0.8</b>
				$V_{RRM} = 1000\text{ V}$		<b>0.7</b>
			<b>0.6</b>			

**Notes**

- JEDEC® registered values are in bold
- (1)  $I^2t$  for time  $t_x = I^2\sqrt{t} \times \sqrt{t_x}$
- (2) Maximum peak reverse current ( $I_{RM}$ ) under same conditions  $\approx 2 \times$  rated  $I_{R(AV)}$

THERMAL AND MECHANICAL SPECIFICATIONS					
PARAMETER	SYMBOL	TEST CONDITIONS		VALUES	UNITS
Maximum operating case and storage temperature range	$T_C, T_{Stg}$			<b>-65 to 200</b>	°C
Maximum internal thermal resistance, junction to case	$R_{thJC}$	DC operation		<b>2.0</b>	°C/W
Thermal resistance, case to sink	$R_{thCS}$	Mounting surface, smooth, flat and greased		0.5	
Mounting torque	minimum	Torque applied to nut; non-lubricated threads		1.36 (12)	N · m (lbf · in)
	maximum			1.69 (15)	
	minimum	Torque applied to nut; lubricated threads		1.07 (9.45)	
	maximum			1.30 (11.55)	
	minimum	Torque applied to device case; lubricated threads		1.17 (10.35)	
	maximum			1.43 (12.65)	
Approximate weight				7.0	g
				0.25	oz.
Case style		JEDEC®		DO-4 (DO-203AA)	

**Note**

- JEDEC registered values are in bold

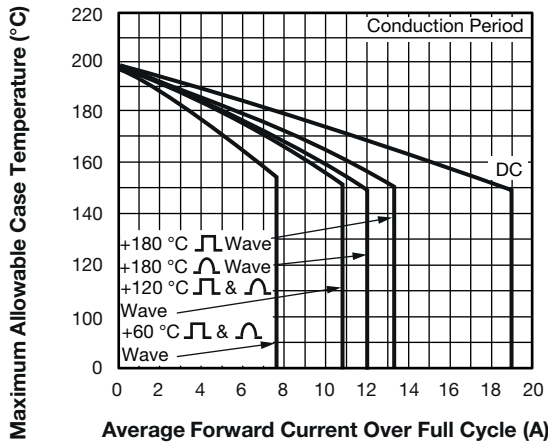

Fig. 1 - Average Forward Current vs. Maximum Allowable Case Temperature

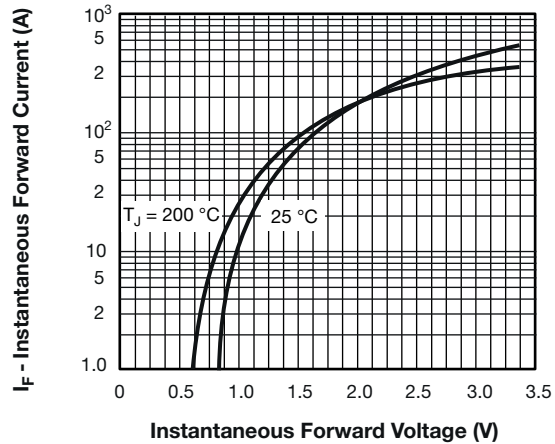

Fig. 4 - Maximum Forward Voltage vs. Forward Current

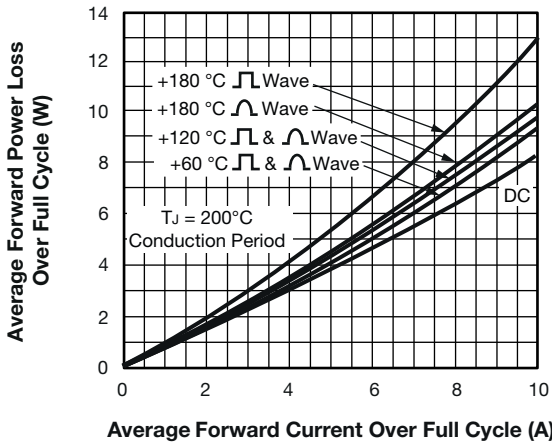

Fig. 2 - Maximum Low Level Forward Power Loss vs. Average Forward Current

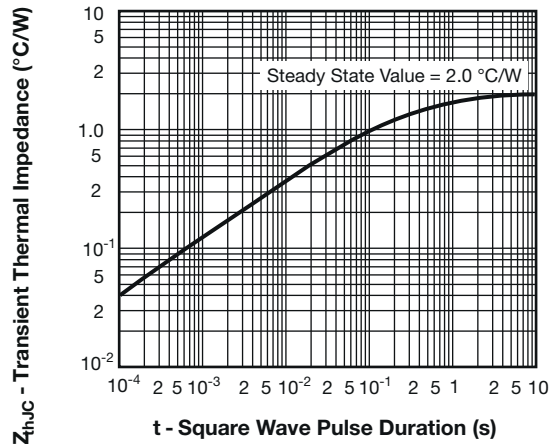

Fig. 5 - Maximum Transient Thermal Impedance, Junction to Case vs. Pulse Duration

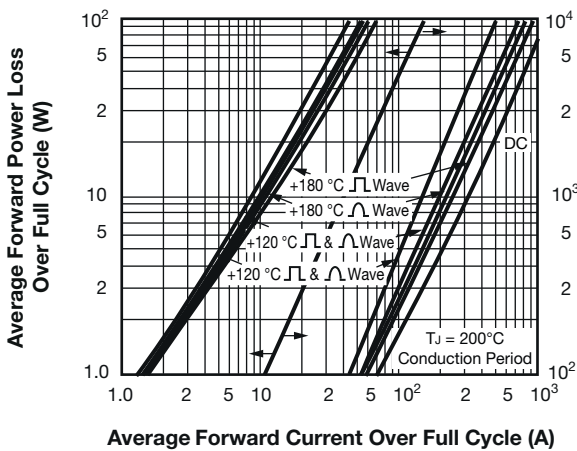

Fig. 3 - Maximum High Level Forward Power Loss vs. Average Forward Current

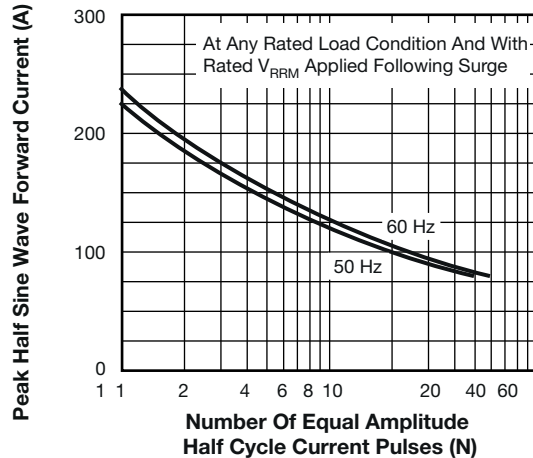

Fig. 6 - Maximum Non-Repetitive 50 Hz Surge Current vs. Number of Current Pulses

LINKS TO RELATED DOCUMENTS

Dimensions	<a href="http://www.vishay.com/doc?95311">www.vishay.com/doc?95311</a>
------------	--

## DO-203AA (DO-4)

**DIMENSIONS** in millimeters (inches)

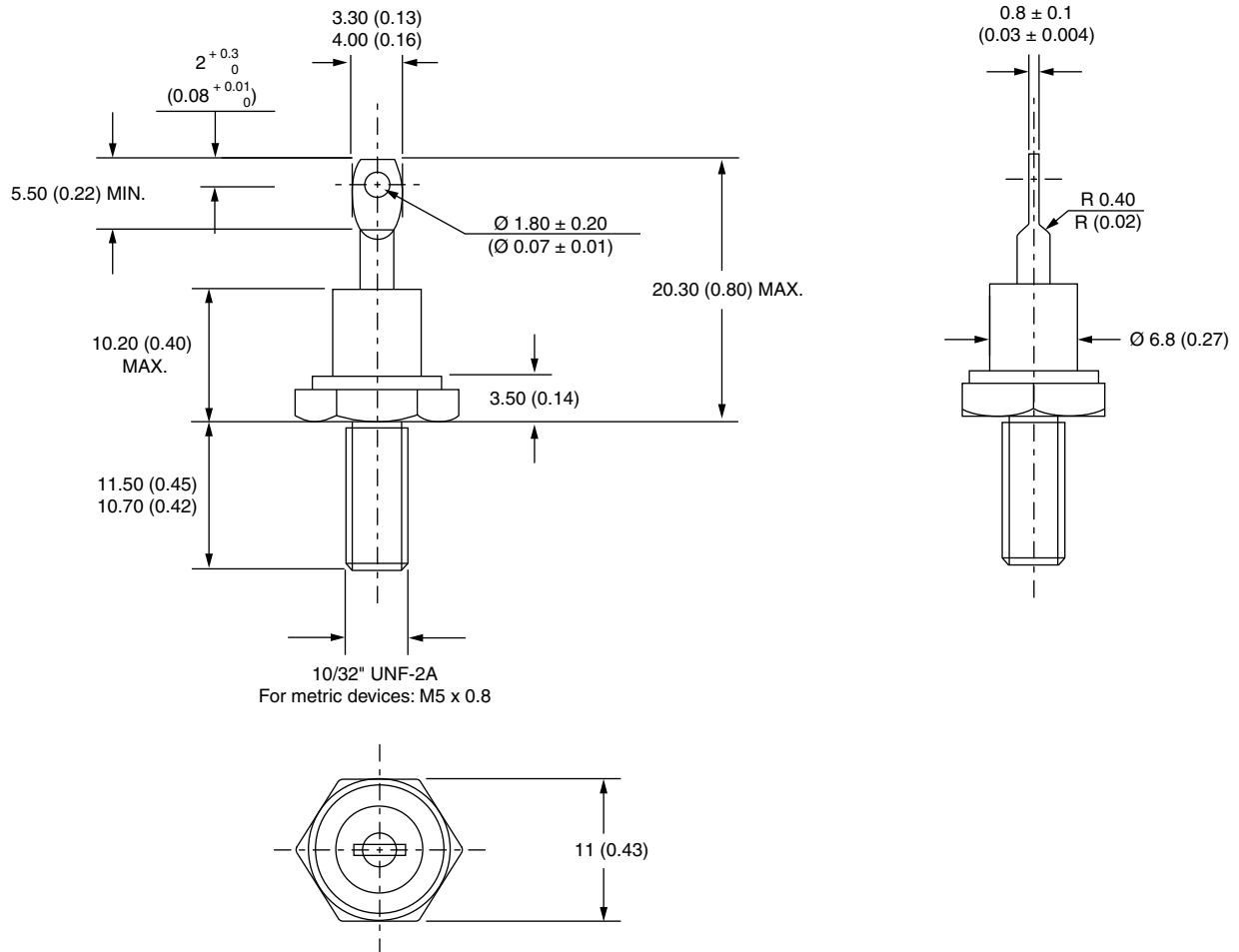



## **Disclaimer**

ALL PRODUCT, PRODUCT SPECIFICATIONS AND DATA ARE SUBJECT TO CHANGE WITHOUT NOTICE TO IMPROVE RELIABILITY, FUNCTION OR DESIGN OR OTHERWISE.

Vishay Intertechnology, Inc., its affiliates, agents, and employees, and all persons acting on its or their behalf (collectively, "Vishay"), disclaim any and all liability for any errors, inaccuracies or incompleteness contained in any datasheet or in any other disclosure relating to any product.

Vishay makes no warranty, representation or guarantee regarding the suitability of the products for any particular purpose or the continuing production of any product. To the maximum extent permitted by applicable law, Vishay disclaims (i) any and all liability arising out of the application or use of any product, (ii) any and all liability, including without limitation special, consequential or incidental damages, and (iii) any and all implied warranties, including warranties of fitness for particular purpose, non-infringement and merchantability.

Statements regarding the suitability of products for certain types of applications are based on Vishay's knowledge of typical requirements that are often placed on Vishay products in generic applications. Such statements are not binding statements about the suitability of products for a particular application. It is the customer's responsibility to validate that a particular product with the properties described in the product specification is suitable for use in a particular application. Parameters provided in datasheets and / or specifications may vary in different applications and performance may vary over time. All operating parameters, including typical parameters, must be validated for each customer application by the customer's technical experts. Product specifications do not expand or otherwise modify Vishay's terms and conditions of purchase, including but not limited to the warranty expressed therein.

Hyperlinks included in this datasheet may direct users to third-party websites. These links are provided as a convenience and for informational purposes only. Inclusion of these hyperlinks does not constitute an endorsement or an approval by Vishay of any of the products, services or opinions of the corporation, organization or individual associated with the third-party website. Vishay disclaims any and all liability and bears no responsibility for the accuracy, legality or content of the third-party website or for that of subsequent links.

Except as expressly indicated in writing, Vishay products are not designed for use in medical, life-saving, or life-sustaining applications or for any other application in which the failure of the Vishay product could result in personal injury or death. Customers using or selling Vishay products not expressly indicated for use in such applications do so at their own risk. Please contact authorized Vishay personnel to obtain written terms and conditions regarding products designed for such applications.

No license, express or implied, by estoppel or otherwise, to any intellectual property rights is granted by this document or by any conduct of Vishay. Product names and markings noted herein may be trademarks of their respective owners.