



# Phase Control Thyristors (Hockey-PUK Version), 2310 A



K-PUK (A-24)

### FEATURES

- Center amplifying gate
- Metal case with ceramic insulator
- International standard case K-PUK (A-24)
- High profile hockey PUK
- Material categorization: for definitions of compliance please see [www.vishay.com/doc?99912](http://www.vishay.com/doc?99912)



RoHS  
COMPLIANT

### TYPICAL APPLICATIONS

- DC motor controls
- Controlled DC power supplies
- AC controllers

PRIMARY CHARACTERISTICS	
$I_{T(AV)}$	2310 A
$V_{DRM}/V_{RRM}$	400 V, 600 V
$V_{TM}$	1.44 V
$I_{GT}$	100 mA
$T_J$	-40 °C to +125 °C
Package	K-PUK (A-24)
Circuit configuration	Single SCR

MAJOR RATINGS AND CHARACTERISTICS			
PARAMETER	TEST CONDITIONS	VALUES	UNITS
$I_{T(AV)}$		2310	A
	$T_{hs}$	55	°C
$I_{T(RMS)}$		4150	A
	$T_{hs}$	25	°C
$I_{TSM}$	50 Hz	42 500	A
	60 Hz	44 500	
$I^2t$	50 Hz	9027	kA <sup>2</sup> s
	60 Hz	8240	
$V_{DRM}/V_{RRM}$		400 to 600	V
$t_q$	Typical	200	µs
$T_J$		-40 to +125	°C

### ELECTRICAL SPECIFICATIONS

VOLTAGE RATINGS				
TYPE NUMBER	VOLTAGE CODE	$V_{DRM}/V_{RRM}$ , MAXIMUM REPETITIVE PEAK AND OFF-STATE VOLTAGE V	$V_{RSM}$ , MAXIMUM NON-REPETITIVE PEAK VOLTAGE V	$I_{DRM}/I_{RRM}$ MAXIMUM AT $T_J = T_J$ MAXIMUM mA
VS-ST1280C..K	04	400	500	100
	06	600	700	



<b>ABSOLUTE MAXIMUM RATINGS</b>					
PARAMETER	SYMBOL	TEST CONDITIONS		VALUES	UNITS
Maximum average on-state current at heatsink temperature	$I_{T(AV)}$	180° conduction, half sine wave Double side (single side) cooled		2310 (885)	A
				55 (85)	°C
Maximum RMS on-state current	$I_{T(RMS)}$	25 °C heatsink temperature double side cooled		4150	
Maximum peak, one-cycle non-repetitive surge current	$I_{TSM}$	t = 10 ms	No voltage reapplied	42 500	A
		t = 8.3 ms		44 500	
		t = 10 ms	100 % $V_{RRM}$ reapplied	35 700	
		t = 8.3 ms		37 400	
Maximum $I^2t$ for fusing	$I^2t$	t = 10 ms	No voltage reapplied	9027	kA <sup>2</sup> s
		t = 8.3 ms		8241	
		t = 10 ms	100 % $V_{RRM}$ reapplied	6383	
		t = 8.3 ms		5828	
Maximum $I^2\sqrt{t}$ for fusing	$I^2\sqrt{t}$	t = 0.1 to 10 ms, no voltage reapplied		90 270	kA <sup>2</sup> √s
Low level value of threshold voltage	$V_{T(TO)1}$	(16.7 % $\times \pi \times I_{T(AV)} < I < \pi \times I_{T(AV)}$ ), $T_J = T_J$ maximum		0.83	V
High level value of threshold voltage	$V_{T(TO)2}$	(I $> \pi \times I_{T(AV)}$ ), $T_J = T_J$ maximum		0.90	
Low level value of on-state slope resistance	$r_{t1}$	(16.7 % $\times \pi \times I_{T(AV)} < I < \pi \times I_{T(AV)}$ ), $T_J = T_J$ maximum		0.077	mΩ
High level value of on-state slope resistance	$r_{t2}$	(I $> \pi \times I_{T(AV)}$ ), $T_J = T_J$ maximum		0.068	
Maximum on-state voltage	$V_{TM}$	$I_{pk} = 8000$ A, $T_J = T_J$ maximum, $t_p = 10$ ms sine pulse		1.44	V
Maximum holding current	$I_H$	$T_J = 25$ °C, anode supply 12 V resistive load		600	mA
Typical latching current	$I_L$			1000	

<b>SWITCHING</b>					
PARAMETER	SYMBOL	TEST CONDITIONS		VALUES	UNITS
Maximum non-repetitive rate of rise of turned-on current	di/dt	Gate drive 20 V, 20 Ω, $t_r \leq 1$ μs $T_J = T_J$ maximum, anode voltage $\leq 80$ % $V_{DRM}$		1000	A/μs
Typical delay time	$t_d$	Gate current 1 A, $dI_g/dt = 1$ A/μs $V_d = 0.67$ % $V_{DRM}$ , $T_J = 25$ °C		1.9	μs
Typical turn-off time	$t_q$	$I_{TM} = 550$ A, $T_J = T_J$ maximum, di/dt = 40 A/μs, $V_R = 50$ V, dV/dt = 20 V/μs, gate 0 V 100 Ω, $t_p = 500$ μs		200	

<b>BLOCKING</b>					
PARAMETER	SYMBOL	TEST CONDITIONS		VALUES	UNITS
Maximum critical rate of rise of off-state voltage	dV/dt	$T_J = T_J$ maximum linear to 80 % rated $V_{DRM}$		500	V/μs
Maximum peak reverse and off-state leakage current	$I_{RRM}$ , $I_{DRM}$	$T_J = T_J$ maximum, rated $V_{DRM}/V_{RRM}$ applied		100	mA



TRIGGERING						
PARAMETER	SYMBOL	TEST CONDITIONS		VALUES		UNITS
				TYP.	MAX.	
Maximum peak gate power	$P_{GM}$	$T_J = T_J$ maximum, $t_p \leq 5$ ms		16		W
Maximum average gate power	$P_{G(AV)}$	$T_J = T_J$ maximum, $f = 50$ Hz, $d\% = 50$		3		
Maximum peak positive gate current	$I_{GM}$	$T_J = T_J$ maximum, $t_p \leq 5$ ms		3.0		A
Maximum peak positive gate voltage	$+V_{GM}$			20		V
Maximum peak negative gate voltage	$-V_{GM}$			5.0		
DC gate current required to trigger	$I_{GT}$	$T_J = -40$ °C	Maximum required gate trigger/ current/voltage are the lowest value which will trigger all units 12 V anode to cathode applied	200	-	mA
		$T_J = 25$ °C		100	200	
		$T_J = 125$ °C		50	-	
DC gate voltage required to trigger	$V_{GT}$	$T_J = -40$ °C		1.4	-	V
		$T_J = 25$ °C		1.1	3.0	
		$T_J = 125$ °C		0.9	-	
DC gate current not to trigger	$I_{GD}$		Maximum gate current/voltage not to trigger is the maximum value which will not trigger any unit with rated $V_{DRM}$ anode to cathode applied	10		mA
DC gate voltage not to trigger	$V_{GD}$	$T_J = T_J$ maximum		0.25		V

THERMAL AND MECHANICAL SPECIFICATIONS					
PARAMETER	SYMBOL	TEST CONDITIONS		VALUES	UNITS
Maximum operating temperature range	$T_J$			-40 to 125	°C
Maximum storage temperature range	$T_{Stg}$			-40 to 150	
Maximum thermal resistance, junction to heatsink	$R_{thJ-hs}$	DC operation single side cooled		0.042	K/W
		DC operation double side cooled		0.021	
Maximum thermal resistance, case to heatsink	$R_{thC-hs}$	DC operation single side cooled		0.006	
		DC operation double side cooled		0.003	
Mounting force, $\pm 10$ %				24 500 (2500)	N (kg)
Approximate weight				425	g
Case style		See dimensions - link at the end of datasheet		K-PUK (A-24)	

$\Delta R_{thJC}$ CONDUCTION						
CONDUCTION ANGLE	SINUSOIDAL CONDUCTION		RECTANGULAR CONDUCTION		TEST CONDITIONS	UNITS
	SINGLE SIDE	DOUBLE SIDE	SINGLE SIDE	DOUBLE SIDE		
180°	0.003	0.003	0.002	0.002	$T_J = T_J$ maximum	K/W
120°	0.004	0.004	0.004	0.004		
90°	0.005	0.005	0.005	0.005		
60°	0.007	0.007	0.007	0.007		
30°	0.012	0.012	0.012	0.012		

**Note**

- The table above shows the increment of thermal resistance  $R_{thJC}$  when devices operate at different conduction angles than DC

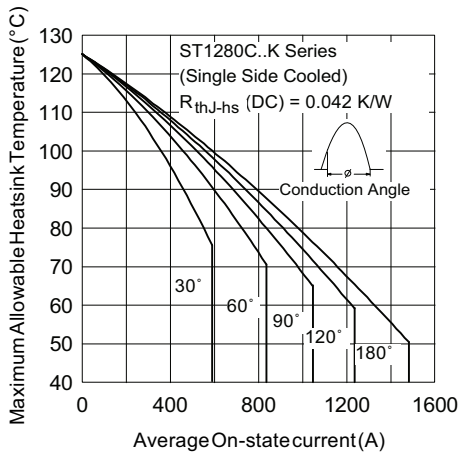

Fig. 1 - Current Ratings Characteristics

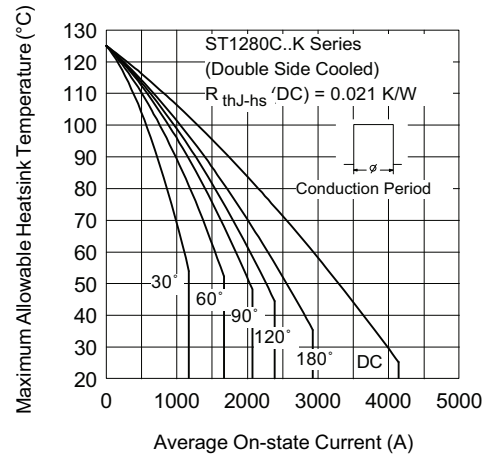

Fig. 4 - Current Ratings Characteristics

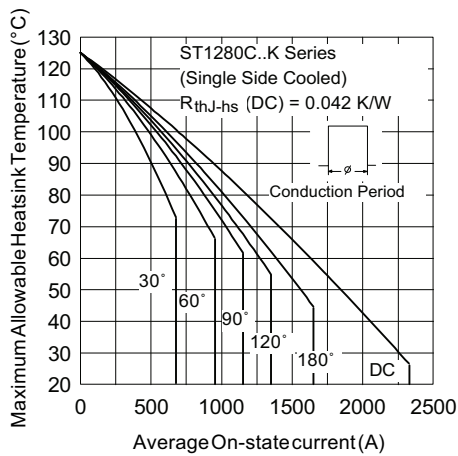

Fig. 2 - Current Ratings Characteristics

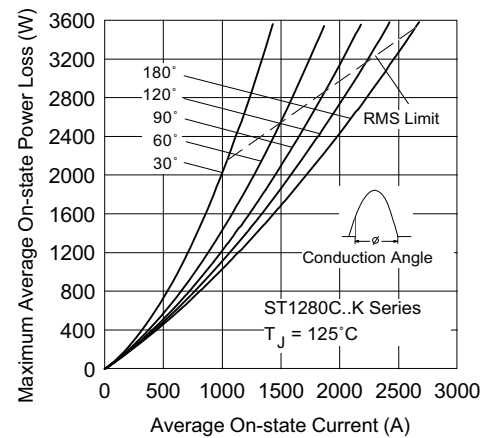

Fig. 5 - On-State Power Loss Characteristics

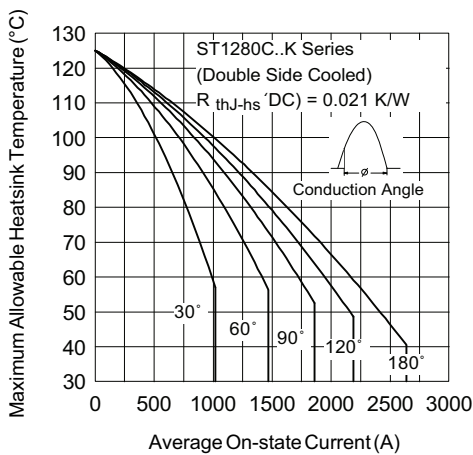

Fig. 3 - Current Ratings Characteristics

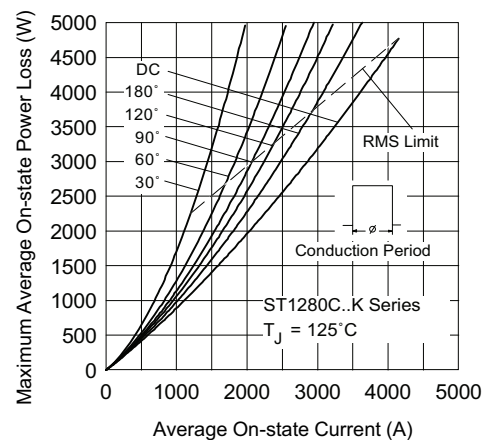

Fig. 6 - On-State Power Loss Characteristics

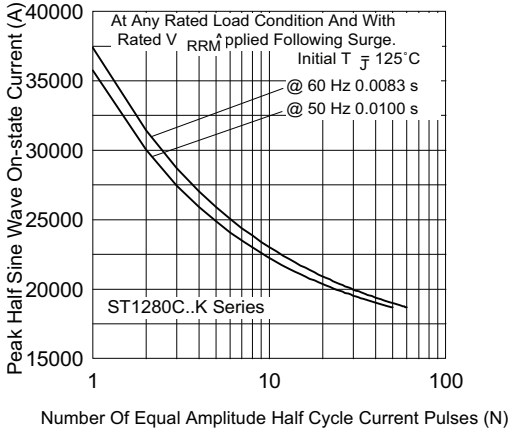

Fig. 7 - Maximum Non-Repetitive Surge Current Single and Double Side Cooled

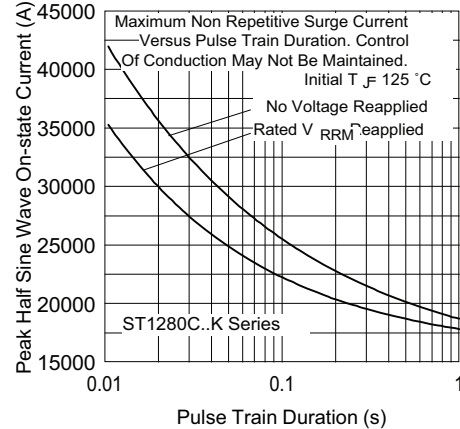

Fig. 8 - Maximum Non-Repetitive Surge Current Single and Double Side Cooled

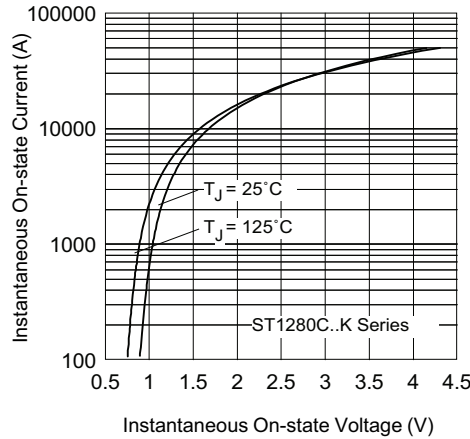

Fig. 9 - On-State Voltage Drop Characteristics

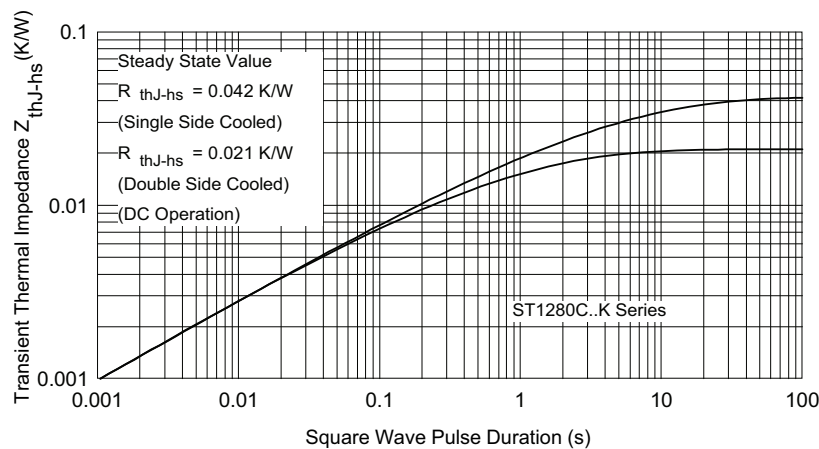

Fig. 10 - Thermal Impedance  $Z_{thJ-hs}$  Characteristics

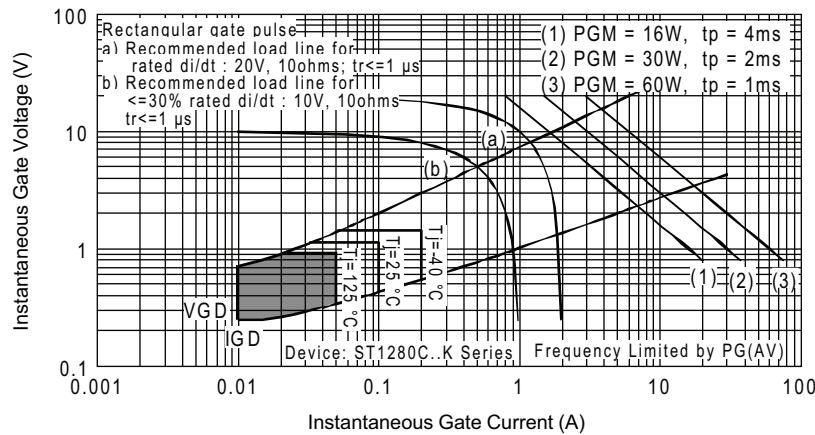

Fig. 11 - Gate Characteristics

**ORDERING INFORMATION TABLE**

Device code	<b>VS-</b>	<b>ST</b>	<b>128</b>	<b>0</b>	<b>C</b>	<b>06</b>	<b>K</b>	<b>1</b>	<b>-</b>
	①	②	③	④	⑤	⑥	⑦	⑧	⑨

- 1** - Vishay Semiconductors product
- 2** - Thyristor
- 3** - Essential part number
- 4** - 0 = converter grade
- 5** - C = ceramic PUK
- 6** - Voltage code x 100 = V<sub>RRM</sub> (see Voltage Ratings table)
- 7** - K = PUK case K-PUK (A-24)
- 8** - 0 = eyelet terminals (gate and auxiliary cathode unsoldered leads)  
 1 = fast-on terminals (gate and auxiliary cathode unsoldered leads)  
 2 = eyelet terminals (gate and auxiliary cathode soldered leads)  
 3 = fast-on terminals (gate and auxiliary cathode soldered leads)
- 9** - Critical dv/dt: • none = 500 V/μs (standard selection)  
 • L = 1000 V/μs (special selection)

LINKS TO RELATED DOCUMENTS	
Dimensions	<a href="http://www.vishay.com/doc?95081">www.vishay.com/doc?95081</a>



## K-PUK (A-24)

**DIMENSIONS** in millimeters (inches)

Creepage distance: 28.88 (1.137) minimum  
Strike distance: 17.99 (0.708) minimum



**Note:**  
A = Anode  
C = Cathode  
G = Gate

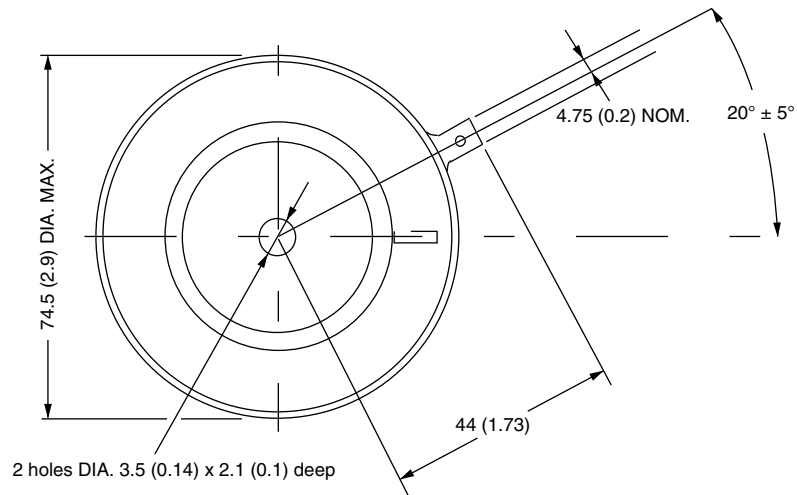

Quote between upper and lower pole pieces has to be considered after application of mounting force (see thermal and mechanical specification)



## Disclaimer

ALL PRODUCT, PRODUCT SPECIFICATIONS AND DATA ARE SUBJECT TO CHANGE WITHOUT NOTICE TO IMPROVE RELIABILITY, FUNCTION OR DESIGN OR OTHERWISE.

Vishay Intertechnology, Inc., its affiliates, agents, and employees, and all persons acting on its or their behalf (collectively, "Vishay"), disclaim any and all liability for any errors, inaccuracies or incompleteness contained in any datasheet or in any other disclosure relating to any product.

Vishay makes no warranty, representation or guarantee regarding the suitability of the products for any particular purpose or the continuing production of any product. To the maximum extent permitted by applicable law, Vishay disclaims (i) any and all liability arising out of the application or use of any product, (ii) any and all liability, including without limitation special, consequential or incidental damages, and (iii) any and all implied warranties, including warranties of fitness for particular purpose, non-infringement and merchantability.

Statements regarding the suitability of products for certain types of applications are based on Vishay's knowledge of typical requirements that are often placed on Vishay products in generic applications. Such statements are not binding statements about the suitability of products for a particular application. It is the customer's responsibility to validate that a particular product with the properties described in the product specification is suitable for use in a particular application. Parameters provided in datasheets and / or specifications may vary in different applications and performance may vary over time. All operating parameters, including typical parameters, must be validated for each customer application by the customer's technical experts. Product specifications do not expand or otherwise modify Vishay's terms and conditions of purchase, including but not limited to the warranty expressed therein.

Hyperlinks included in this datasheet may direct users to third-party websites. These links are provided as a convenience and for informational purposes only. Inclusion of these hyperlinks does not constitute an endorsement or an approval by Vishay of any of the products, services or opinions of the corporation, organization or individual associated with the third-party website. Vishay disclaims any and all liability and bears no responsibility for the accuracy, legality or content of the third-party website or for that of subsequent links.

Except as expressly indicated in writing, Vishay products are not designed for use in medical, life-saving, or life-sustaining applications or for any other application in which the failure of the Vishay product could result in personal injury or death. Customers using or selling Vishay products not expressly indicated for use in such applications do so at their own risk. Please contact authorized Vishay personnel to obtain written terms and conditions regarding products designed for such applications.

No license, express or implied, by estoppel or otherwise, to any intellectual property rights is granted by this document or by any conduct of Vishay. Product names and markings noted herein may be trademarks of their respective owners.