

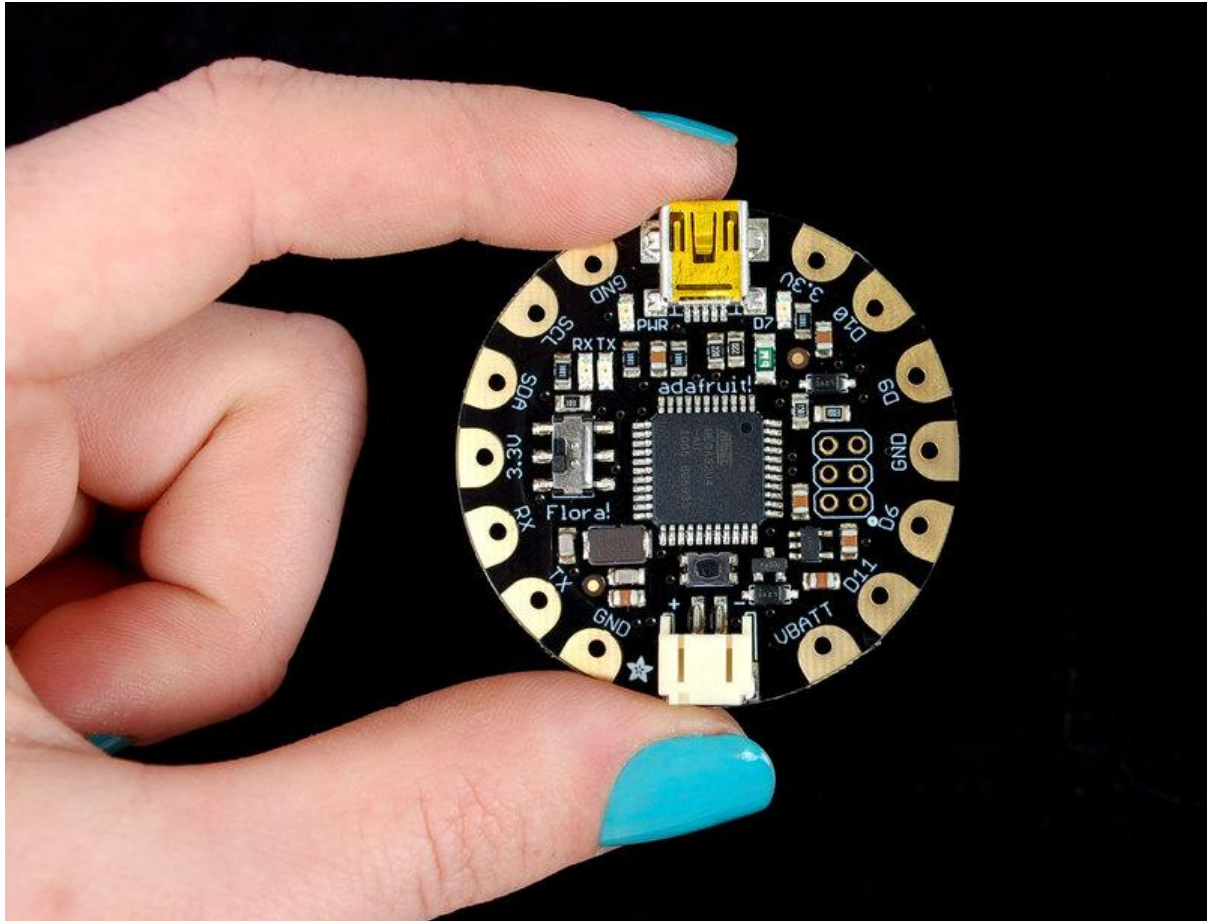

Getting Started with FLORA

Created by Becky Stern



<https://learn.adafruit.com/getting-started-with-flora>

Last updated on 2022-12-01 01:53:21 PM EST

Table of Contents

Overview	3
Windows Driver Installation	5
<ul style="list-style-type: none">• Manual Driver Installation	
Download software	8
Blink onboard LED	9
Blink onboard NeoPixel	11
<ul style="list-style-type: none">• Install the NeoPixel Library• Demo Code	
Power your FLORA	13
<ul style="list-style-type: none">• The VBATT Pad	
FLORA pinout diagram	15
<ul style="list-style-type: none">• What about SPI?• Some Technical Specs:	
FLORA projects	17
FLORA techniques	18
FLORA modules	18
Downloads	19
<ul style="list-style-type: none">• Files• Schematic & Fabrication Print	

Overview

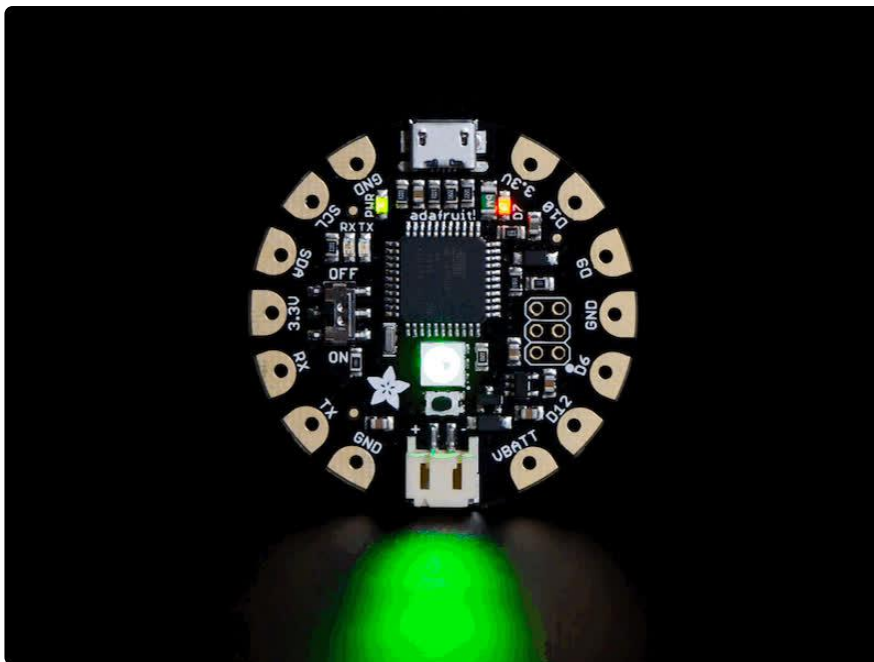
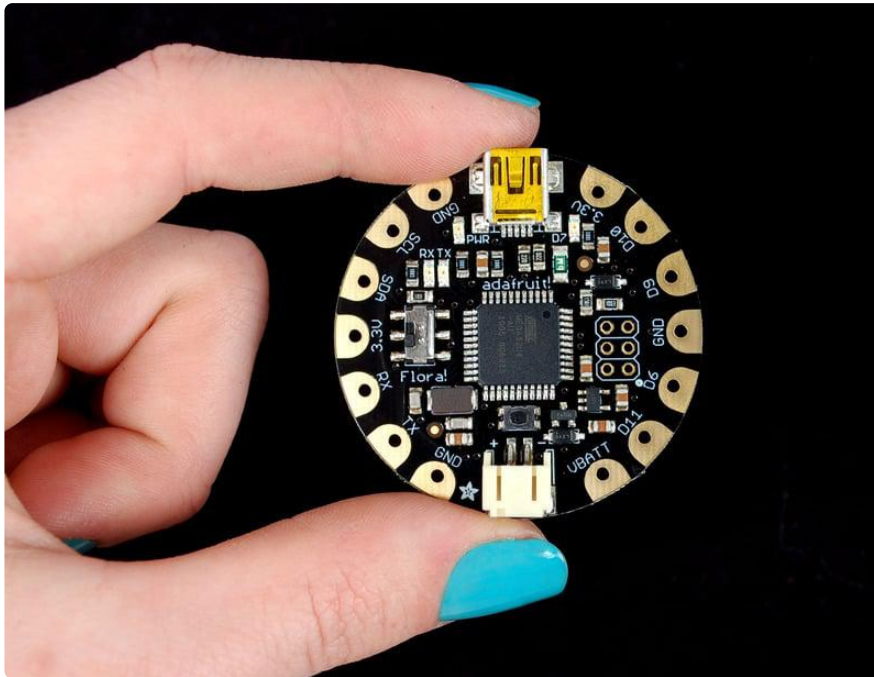

FLORA is Adafruit's wearable electronics platform. We designed it from the ground up to provide the best experience for Adafruit's community of makers, hackers, crafters, artists, designers and engineers. It's built around the Atmega32u4 chip, which has built-in USB support. No pesky special cables or extra parts for programming, just plug it in and get started making the wearables project of your dreams! Works on Windows and Mac.

New! As of May 12th, 2015, we're now selling the Flora v2! The Flora v2 now comes with a micro-USB port instead of a mini-USB port and a programmable NeoPixel installed (it's connected to Digital 8, ready for your blinky commands)

The FLORA is extremely beginner-friendly-- it is difficult to destroy the FLORA by connecting a battery backwards due to polarized connector and protection diodes. The onboard regulator means that even connecting a 9V battery will not result in damage or tears.

This guide is the first step in using FLORA, plugging it in and programming it to blink its onboard LED! After that you can move on to our [Flora RGB Smart Pixels tutorial \(\)](#) and/or [Flora GPS tutorial \(\)](#).

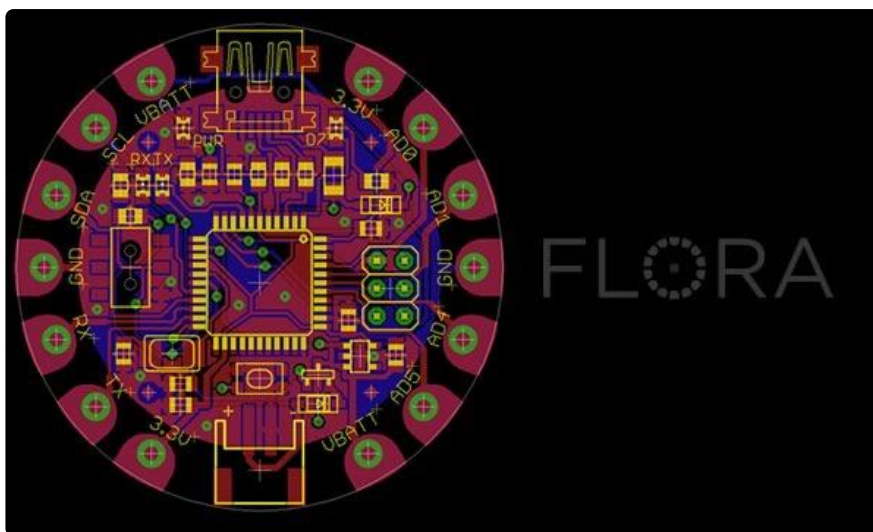

Adafruit created the FLORA from scratch after many months of research and we really think we came up with something that will empower some amazing wearable projects.

The FLORA is small (1.75" diameter). We wanted the smallest possible board for our wearable platform. It's based on our experiences shipping our own, shipping, customer-tested [Atmega32u4 \(http://adafru.it/296\)](http://adafru.it/296) [Breakout Board \(http://adafru.it/296\)](http://adafru.it/296).

FLORA has a small but easy to use onboard reset button to reboot the system. The power supply is designed to be flexible and easy to use. There is an onboard polarized 2 JST battery connector with protection schottky diode for use with external battery packs from 3.5v to 9v DC in (It can run on 3V but 3.5V-5V or higher is ideal). Can be used with Lilon/LiPoly, LiFe, alkaline or rechargeable NiMh/NiCad batteries of any size.

The FLORA does not have a LiPo charger included by design, this allows safe use with multiple battery types and reduces risk of fire as it is not recommended to charge these batteries on fabric.

FLORA has built-in USB support. Built in USB means you plug it in to program it, it just shows up. No additional purchases are needed! Works with Mac, Windows, Linux, any USB cable works great. Currently the PCB comes with a mini B connector but future versions may change to microUSB.

The FLORA has USB HID support, so it can act like a mouse or keyboard, etc.



Windows Driver Installation

Mac and Linux do not require drivers, only Windows folks need to do this step

Windows 10 users probably can skip this step, because Windows 10 already has many drivers built in. Try skipping the installation first to see if it's unnecessary.

Before you plug in your board, you'll need to possibly install a driver!

Click below to download our Driver Installer.

[Download Latest Adafruit Windows Driver Installer](#)

Download and run the installer.

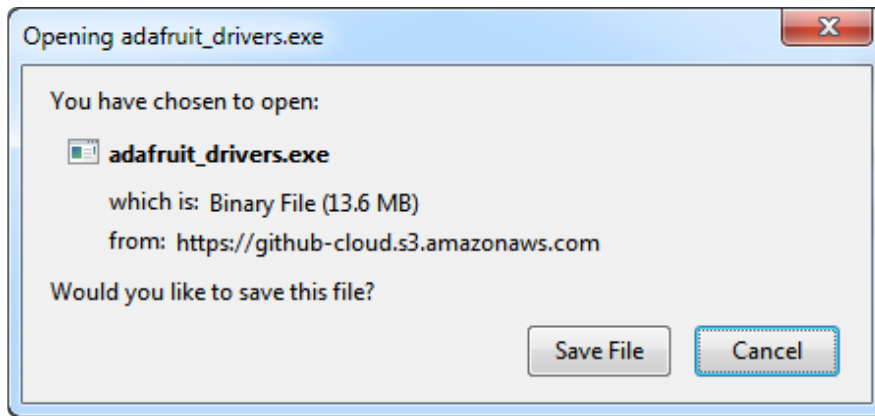

Run the installer! Since we bundle the SiLabs and FTDI drivers as well, you'll need to click through the license

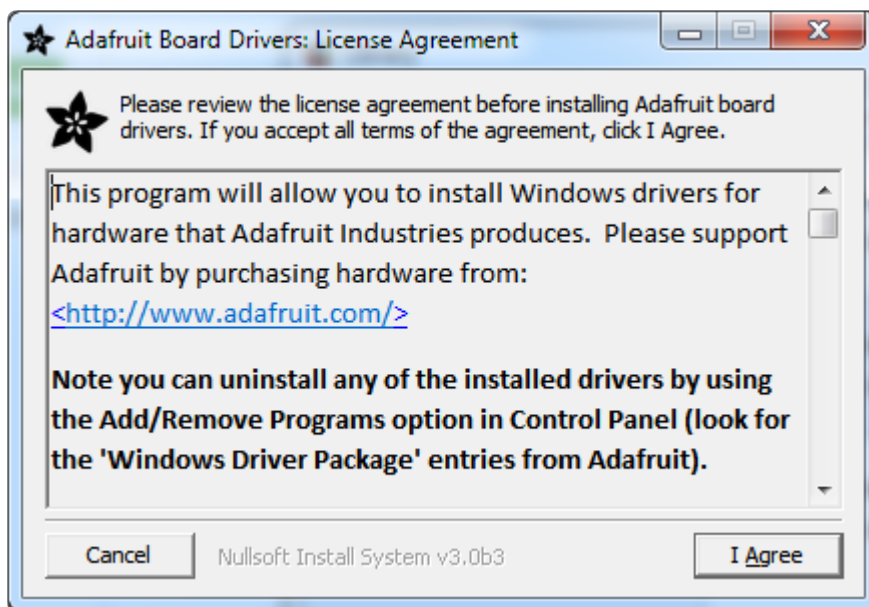

Select which drivers you want to install, we suggest selecting all of them so you don't have to do this again!

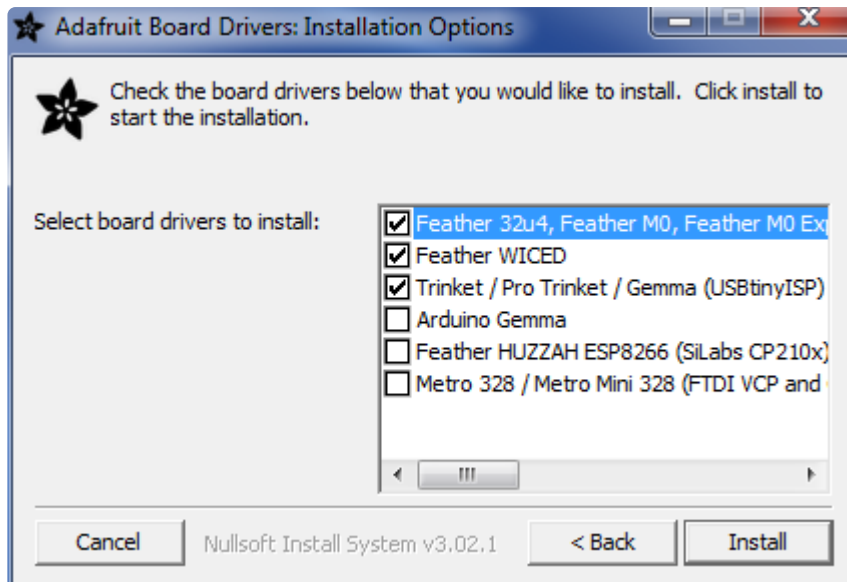

As of version 2.5.0.0, the Adafruit drivers package is no longer signed, and some of the drivers it contains are also no longer signed. You'll need to click the second item in this dialog box when it appears:

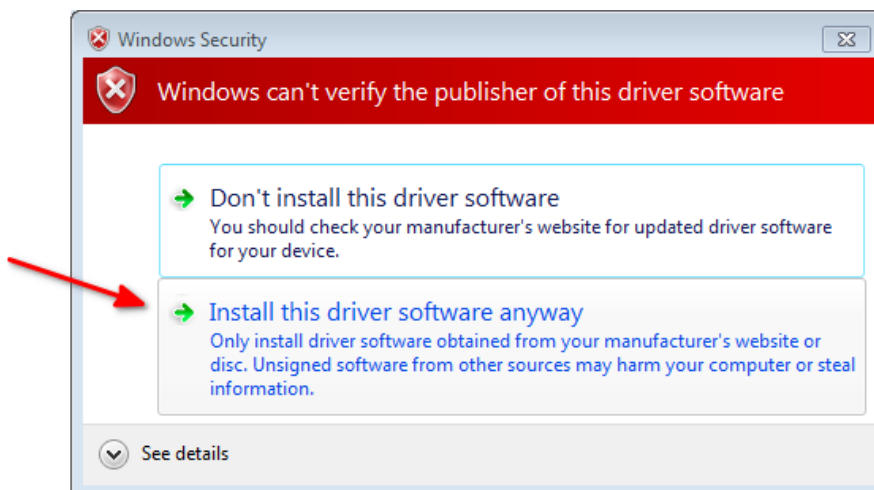

On Windows 7, by default, we install a single driver for most of Adafruit's boards, including the Feather 32u4, the Feather M0, Feather M0, Express, Circuit Playground, Circuit Playground Express, Gemma M0, Trinket M0, Metro M0 Express. On Windows 10 and 11 that driver is not necessary (it's built in to Windows) and it will not be listed.

The Trinket / Pro Trinket / Gemma / USBtinyISP drivers are also installed by default.

You can also, optionally, install the Arduino Gemma (different than the Adafruit Gemma!), Huzzah and Metro 328 drivers.

Click Install to do the installin'.

Note that on Windows 10 and Windows 11, support for many boards is built in. If you end up not checking any boxes, you don't need to run the installer at all!

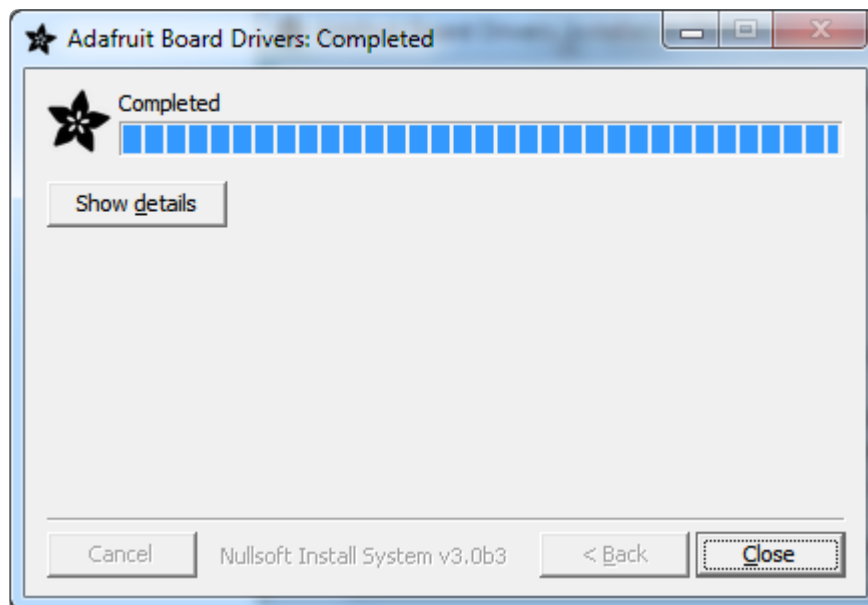

Manual Driver Installation

If windows needs the driver files (inf/cat) for some reason you can get all the drivers by downloading the source code zip file from this link:

Latest Adafruit Windows Drivers
release

And point windows to the Drivers folder when it asks for the driver location

Download software

To install the software for programming Flora just follow the steps in the steps in the [Adafruit Arduino IDE setup guide \(\)](#) to easily install support for Flora into your Arduino IDE 1.6 or higher

When you're finished installing the IDE come back to this page to continue the Flora guide.

On Windows be sure to install the Flora driver as noted on the Windows install page here: <https://learn.adafruit.com/adafruit-arduino-ide-setup/windows-setup>

Blink onboard LED

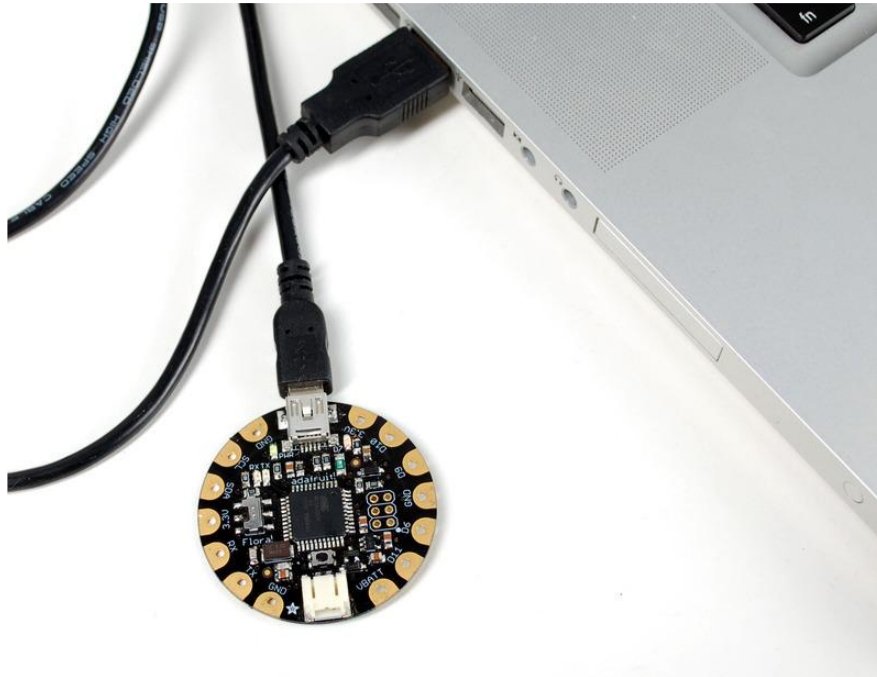

Next it's time to load up a program on your FLORA. There is an LED on board, so let's blink it! Plug in the USB cable and paste the following code into the Adafruit Flora IDE:

```
// Pin D7 has an LED connected on FLORA.
// give it a name:
int led = 7;

// the setup routine runs once when you press reset:
void setup() {
  // initialize the digital pin as an output.
  pinMode(led, OUTPUT);
}

// the loop routine runs over and over again forever:
void loop() {
  digitalWrite(led, HIGH); // turn the LED on (HIGH is the voltage level)
  delay(1000);             // wait for a second
  digitalWrite(led, LOW); // turn the LED off by making the voltage LOW
  delay(1000);            // wait for a second
}
```

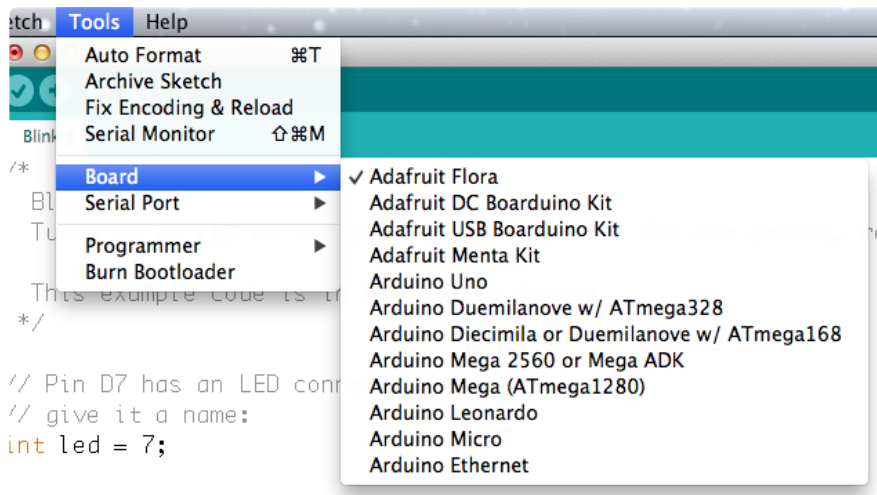

From the Tools menu, under "Board," choose "Adafruit Flora"

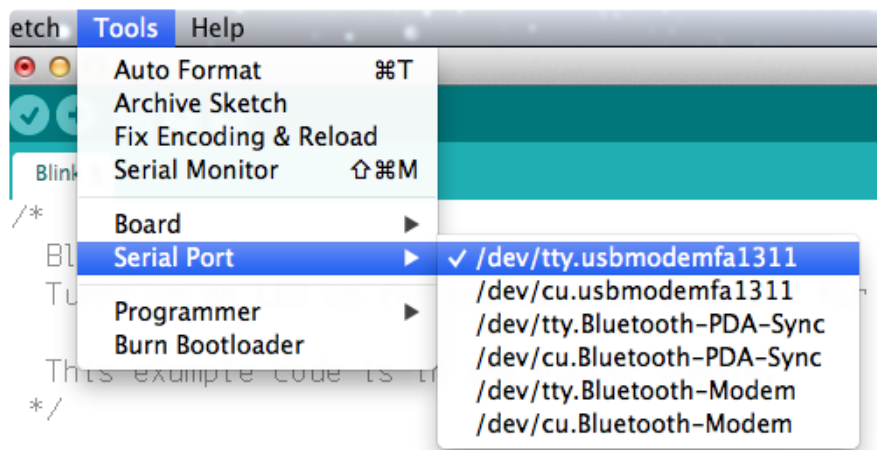

Also in the Tools menu, under "Serial Port," choose the one that contains the phrase "usbmodem" if you have a Mac.

If you're using a Windows computer, it will be named COMsomething, but not COM1 or COM2 (so it will be whatever comes after those two if they exist, such as COM3 or COM4).



Press the Upload button to transmit the program to the FLORA. It looks like an arrow pointing to the right.

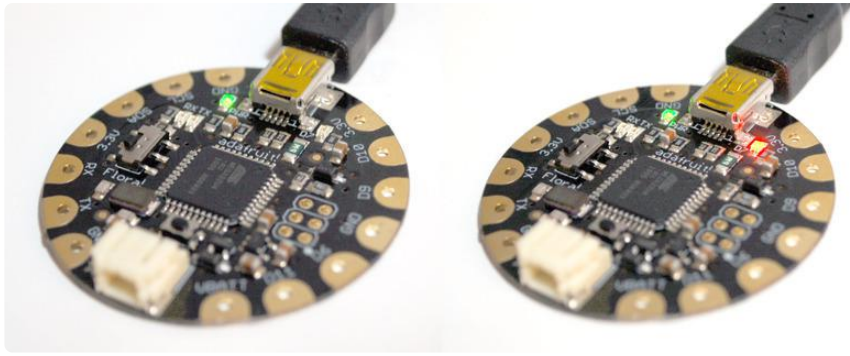

That's it! The on board LED marked "D7" should blink on and off repeatedly, and you've successfully programmed your FLORA!

Blink onboard NeoPixel

If you have a Flora v2, your Flora comes with an onboard NeoPixel! This lets you have a nice glowy LED using only one pin (Digital 8)

Install the NeoPixel Library

If you are running Arduino IDE 1.6.1 or higher, you can install the library using the built in library manager, search for and install Adafruit_NeoPixel

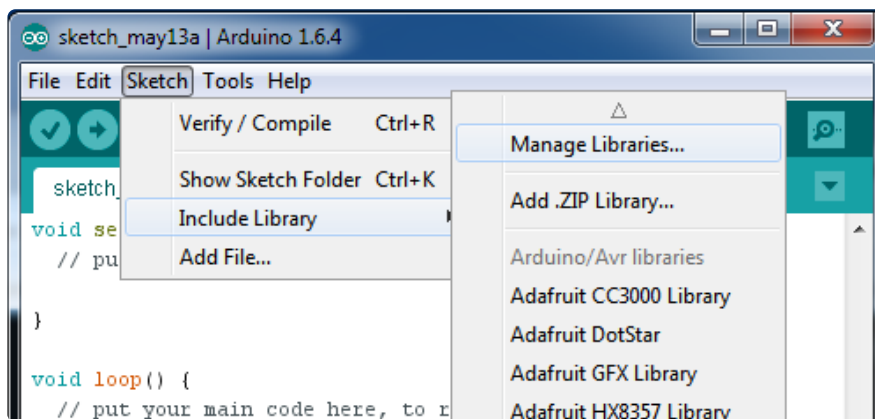

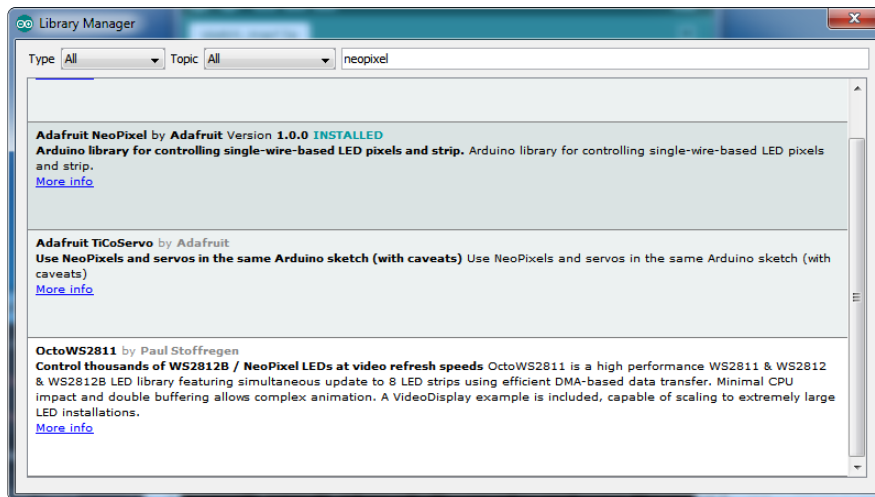

Install and close out the Library manager.

[If you're not able to use the library manager or have an older IDE, you can always 'manually' install the library! \(\)](#)

Demo Code

Upload the following sketch, note that we consider the 'strip' to be 1 pixel long, and connected to Digital 8

```
#include <Adafruit_NeoPixel.h>

#define PIN 8

Adafruit_NeoPixel strip = Adafruit_NeoPixel(1, PIN, NEO_GRB + NEO_KHZ800);

void setup() {
  strip.begin();
  strip.setBrightness(50);
  strip.show(); // Initialize all pixels to 'off'
}

void loop() {
  // Some example procedures showing how to display to the pixels:
  colorWipe(strip.Color(255, 0, 0), 500); // Red
  colorWipe(strip.Color(0, 255, 0), 500); // Green
  colorWipe(strip.Color(0, 0, 255), 500); // Blue
  rainbowCycle(20);
}

// Fill the dots one after the other with a color
void colorWipe(uint32_t c, uint8_t wait) {
  for(uint16_t i=0; i<strip.numPixels(); i++) {
    strip.setPixelColor(i, c);
    strip.show();
    delay(wait);
  }
}

// Slightly different, this makes the rainbow equally distributed throughout
void rainbowCycle(uint8_t wait) {
```

```

uint16_t i, j;

for(j=0; j<256*5; j++) { // 5 cycles of all colors on wheel
  for(i=0; i<strip.numPixels(); i++) {
    strip.setPixelColor(i, Wheel(((i * 256 / strip.numPixels()) + j) & 255));
  }
  strip.show();
  delay(wait);
}

// Input a value 0 to 255 to get a color value.
// The colours are a transition r - g - b - back to r.
uint32_t Wheel(byte WheelPos) {
  WheelPos = 255 - WheelPos;
  if(WheelPos < 85) {
    return strip.Color(255 - WheelPos * 3, 0, WheelPos * 3);
  } else if(WheelPos < 170) {
    WheelPos -= 85;
    return strip.Color(0, WheelPos * 3, 255 - WheelPos * 3);
  } else {
    WheelPos -= 170;
    return strip.Color(WheelPos * 3, 255 - WheelPos * 3, 0);
  }
}

```

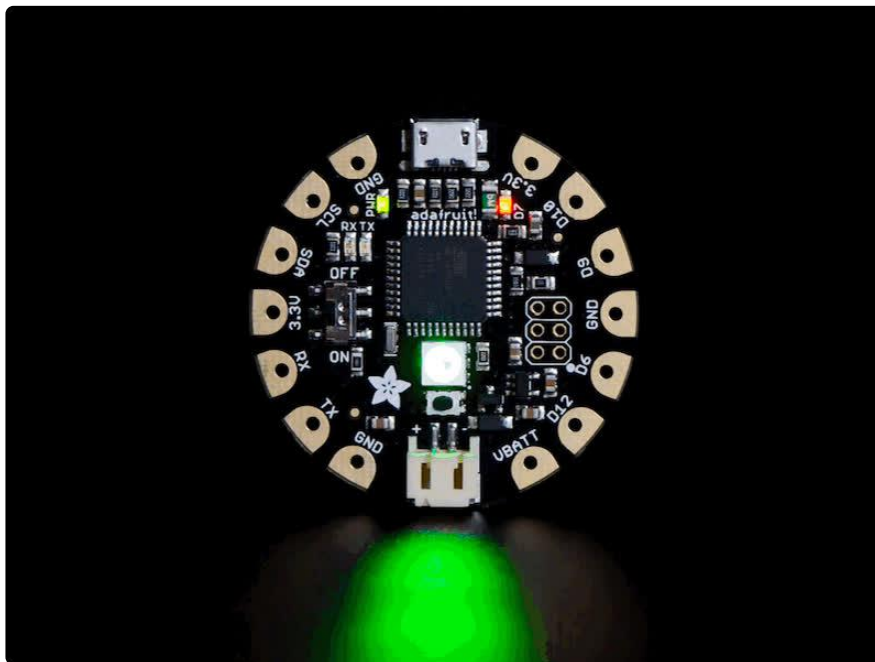

Power your FLORA

The Flora runs at 3.3V with an onboard regulator to keep the voltage steady. You'll need to power the board with a 3.6V or greater battery. For that reason, we find 3 x AA or AAA or a lithium-polymer battery to be ideal. You can only power FLORA through its onboard JST port.

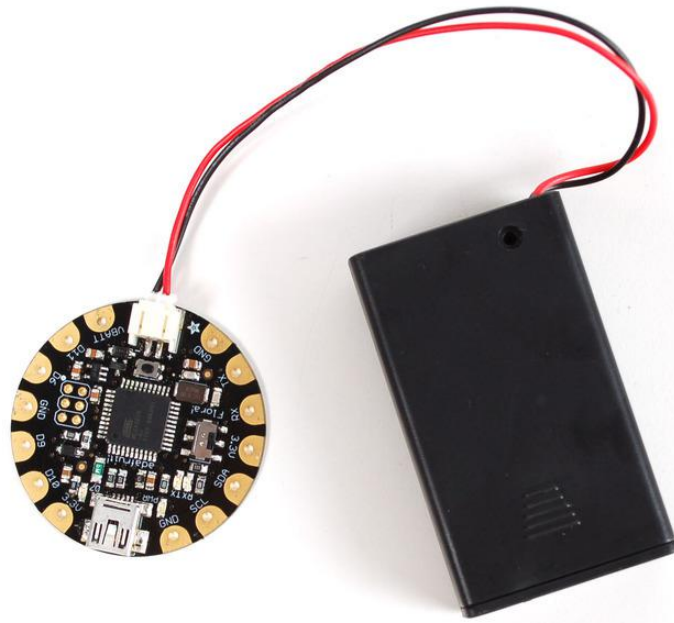

After loading your program onto the FLORA, you'll want to unplug the USB cable and go portable with battery power! USB will always power the board, but battery power (through the JST connector) can be turned on and off with Flora's onboard switch (near the "ON" text on the board). We recommend our [3xAAA holder \(http://adafru.it/727\)](http://adafru.it/727) for beginners, which conveniently plugs into FLORAs JST port.

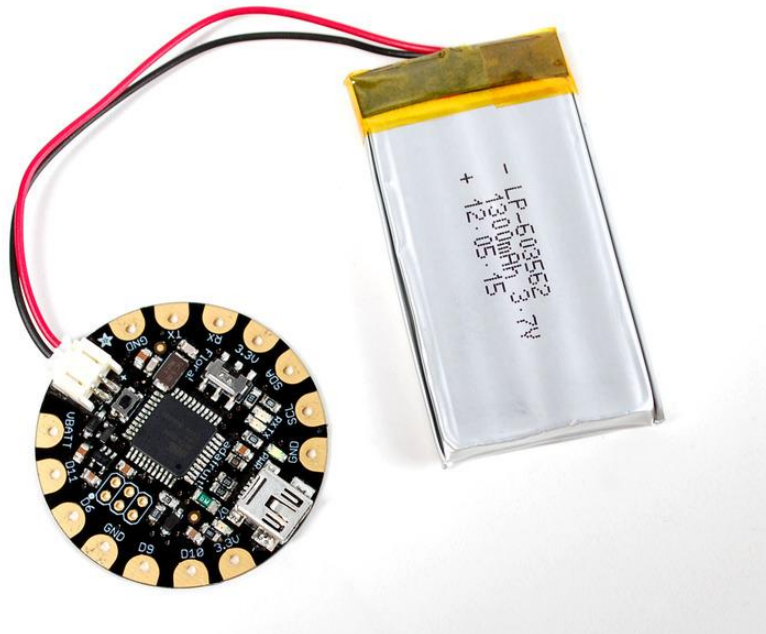

More advanced users may wish to use a rechargeable [lithium polymer battery \(http://adafru.it/258\)](http://adafru.it/258) for their smaller size and longer duration. These batteries pose added risk if abused, shorted, bent, crushed, or punctured. FLORA does not have onboard charging, so you would also need a separate [LiPoly charger \(http://adafru.it/259\)](http://adafru.it/259).

The VBATT Pad

The most commonly confused part of the Flora is the VBATT pad and how power management is handled in the Flora. We designed the flora to be mainly powered via the JST connector. You can power it with a battery pack or lipo battery. That input is polarity protected and also controlled via the on/off switch. The battery output after the switch is VBATT. You shouldn't use VBATT as an input as you might damage your battery if you also plug in the USB connector to a computer! The ideal use of VBATT is when you want to power something like NeoPixels or a servo, something that requires more than the 150mA available from the onboard regulator.

FLORA pinout diagram

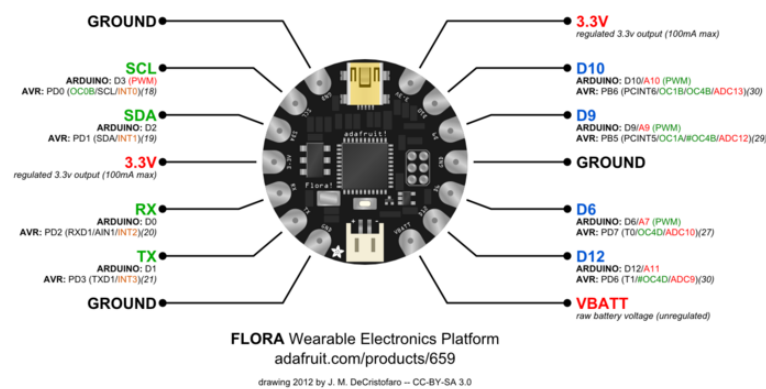

For handy reference, we've created this pinout diagram illustrating all the alternate functions for each of the pins on the Flora.

The most commonly confused part of the Flora is the VBATT pad and how power management is handled in the Flora. We designed the flora to be mainly powered via the JST connector. You can power it with a battery pack or lipo battery. That input is polarity protected and also controlled via the on/off switch. The battery output after the switch is VBATT. You shouldn't use VBATT as an input as you might damage your battery if you also plug in the USB connector to a computer! The ideal use of VBATT is when you want to power something like NeoPixels or a servo, something that requires more than the 150mA available from the onboard regulator.

What about SPI?

The Flora also supports hardware SPI. The SPI pins are on the 2x3 header near the center of the Flora. A small white dot indicates pin 1. The SPI header pinout is shown here:

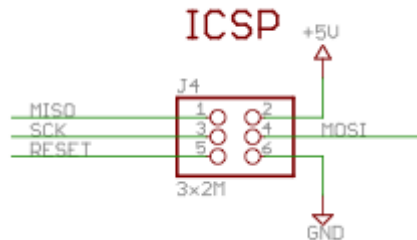

Some Technical Specs:

- Battery input (JST): 3.5-16V ([the regulator is MIC5225-3.3 \(\)](#)) with reverse polarity protection, 2A max rated connector. We recommend no more than 6VDC so that the 3.3V regulator does not overheat
- USB input: 4.5V-5.5V with 500mA fuse
- 3.3V output pad: we recommend no more than 100mA, as the regulator can supply 150mA and the Flora Mainboard uses 20mA. but you can probably draw up to 250mA in spikes
- Clock speed: 8MHz
- Chipset: ATmega32u4
- VBAT output pad: the higher of the VBAT JST input voltage and USB voltage (two schottkey diode connection)
- Current Draw: 8mA quiescent, another 2mA when the pin #D7 LED is on.

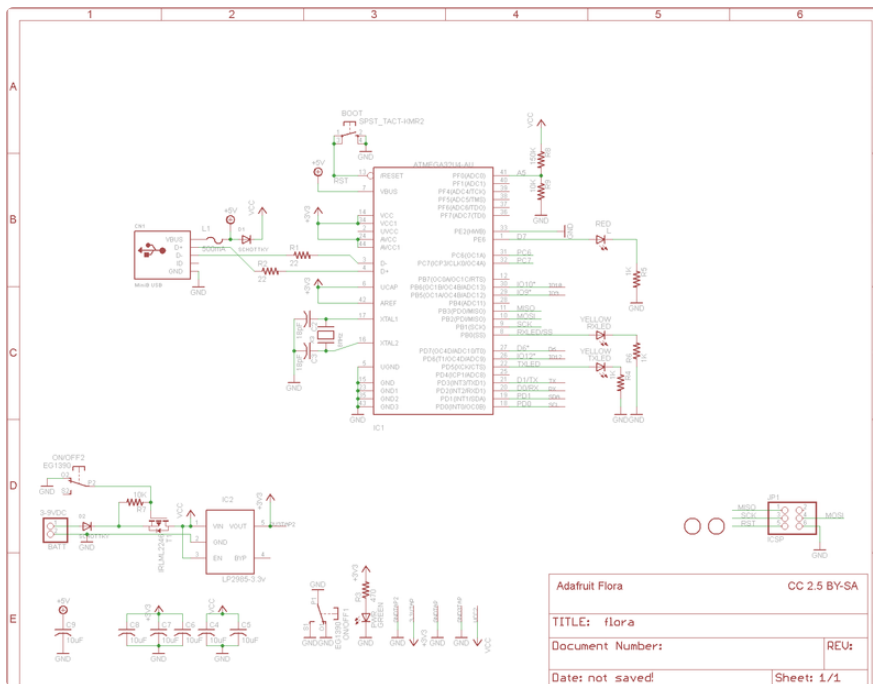

FLORA projects

[Flora Pixel Brooch \(\)](#)



[Flora TV-B-Gone \(\)](#)

[GPS Jacket \(\)](#)

[Capacitive Touch with Conductive Fabric \(\)](#)

[Wearable Piezo Tones \(\)](#)

[LED Ampli-Tie \(\)](#)

[Plush Game Controller \(\)](#)

FLORA techniques

[Flora snaps \(\)](#)

[Conductive thread \(\)](#)

[Capacitive Touch with Conductive Fabric & Flora \(\)](#)

FLORA modules

[FLORA Accelerometer + Compass \(\)](#)

[FLORA Luminosity Sensor \(\)](#)

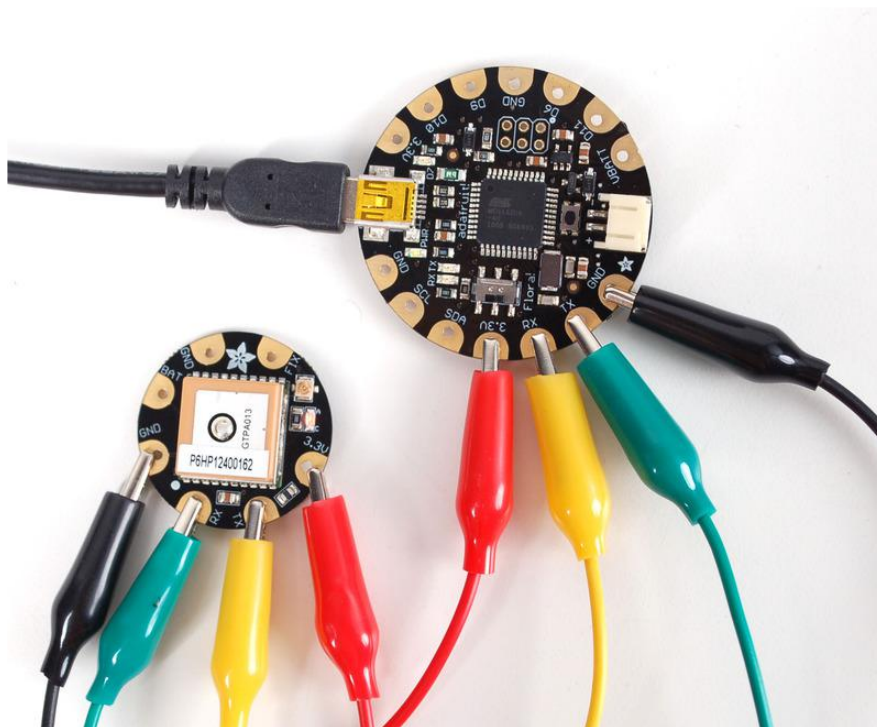

[FLORA GPS \(\)](#)

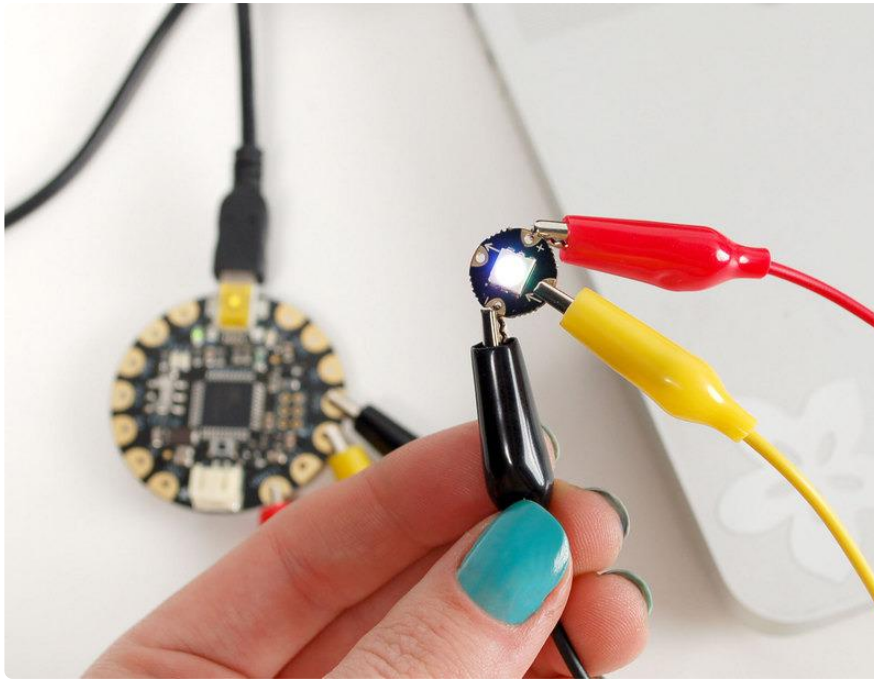

[Flora RGB Smart NeoPixels \(\)](#)

Downloads

Files

- [EagleCAD PCB files on GitHub \(\)](#)
- [Fritzing object in Adafruit Fritzing library \(\)](#)

Schematic & Fabrication Print

