

CBT-90-RX/B

Thermally Enhanced LED Package

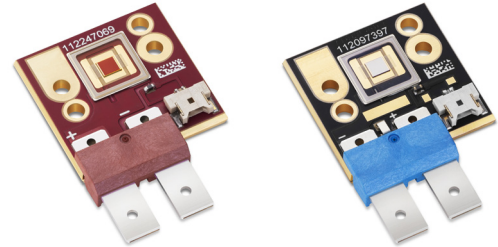

Table of Contents

Technology Overview2

Ordering Information3

Binning Structure4

Typical Device Performance.....6

Absolute Maximum Ratings7

Optical and Electrical Characteristics8

Angular Intensity Distribution..... 10

Typical Spectrum 11

Thermal Resistance 12

Mechanical Dimensions .. 13

Packaging Information ... 15

Revision History 17

Features

- Large, monolithic chip with uniform emitting area of 9 mm²
- Wide color gamut available for Red and Blue single color LEDs. Green, White and UV CBT-90 LEDs are also available with the same package format
- Ultra High thermal conductivity package allows operation at up to 27A CW
- High precision LEDs placement on copper core PCB for easier thermal management and optical integration
- Unencapsulated die with low profile protective window optimizes optical coupling in etendue-limited applications
- Environmentally friendly: RoHS and REACH compliant

Applications

- Fiber-coupled Illumination
- Architectural and Entertainment Lighting
- Medical Lighting
- Machine Vision
- Microscopy
- Displays and Signage
- General Illumination
- Spot Lighting
- Emergency Vehicle Lighting
- Projection Systems

Technology Overview

Luminus LEDs benefit from a suite of innovations in the fields of chip technology, packaging and thermal management. These breakthroughs allow illumination engineers and designers to achieve solutions that are high brightness and high efficiency.

Luminus LED Technology

Luminus' Devices vertical chip LED technology enables large area LED chips with uniform brightness over the entire LED chip surface. The optical power and brightness produced by these large monolithic chips enable solutions which replace arc and halogen lamps where arrays of traditional high power LEDs cannot.

Packaging Technology

Thermal management is critical in high power LED applications. With a thermal resistance from junction to heat sink of 0.5° C/W, Luminus CBT-90 LEDs have the lowest thermal resistance of any LED on the market. This allows the LED to be driven at higher current densities while maintaining a low junction temperature, thereby resulting in brighter solutions and longer lifetimes.

Environmental Benefits

Luminus LEDs help reduce power consumption and the amount of hazardous waste entering the environment. All LED products manufactured by Luminus are RoHS compliant and free of hazardous materials, including lead and mercury.

Reliability

Designed from the ground up, Luminus LEDs are one of the most reliable light sources in the world today. Luminus LEDs have passed a rigorous suite of environmental and mechanical stress tests, including mechanical shock, vibration, temperature cycling and humidity, and have been fully qualified for use in extreme high power and high current applications. With very low failure rates and median lifetimes that typically exceed 60,000 hours, Luminus LEDs are ready for even the most demanding applications.

Static Electricity

The products are sensitive to static electricity, and care should be taken when handling them. Static electricity or surge voltage will damage the LEDs. It is recommended to wear an anti-electrostatic wristband or an anti-electrostatic gloves when handling the LEDs. All devices, equipment and machinery must be properly grounded. It is recommended that measures be taken against surge voltage to the equipment that mounts the LEDs.

Reference: APN-002815 Electrical Stress Damage to LEDs and How to Prevent It

Understanding Luminus LED Test Specifications

Every Luminus LED is fully tested to ensure that it meets the high quality standards expected from Luminus' products.

Testing of Luminus LEDs

Luminus core board products are typically measured in such a way that the characteristics reported agree with how the devices will actually perform when incorporated into a system. This measurement is accomplished by mounting the devices on a 40°C heat sink and allowing the device to reach thermal equilibrium while fully powered. Only after the device reaches

equilibrium are the measurements taken. This method of measurement ensures that Luminus LEDs perform in the field just as they are specified.

Expected flux values in real world operation can be extrapolated based on the information contained within this product data sheet.

Ordering Information

Ordering Part Numbers

Color	Luminous Flux		Wavelength Bins	Ordering Part Number
	Min. Flux/ Power Bin	Min. Flux/ Power		
Red	BM	770 lm	R2, R3, R4, R5, R6	CBT-90-RX-L15-BM100
			R3, R4, R5	CBT-90-RX-L15-BM101
	BN	970 lm	R2, R3, R4, R5, R6	CBT-90-RX-L15-BN100
			R3,R4,R5	CBT-90-RX-L15-BN101
Blue	G	8.30 W	445,450,455,460,465	CBT-90-B-L11-G100
			450,455,460	CBT-90-B-L11-G101
	H	9.10 W	445,450,455,460,465	CBT-90-B-L11-H100
			450,455,460	CBT-90-B-L11-H101
	J	10.0 W	445,450,455,460,465	CBT-90-B-L11-J100
			450,455,460	CBT-90-B-L11-J101

Part Number Nomenclature

CBT — 90 — CC — L## — <Bin kit>

Product Family	Chip Area	Color	Package Configuration	Bin Kit ¹
CBT: Copper-core PCB, no encapsulation	90: 9 mm ²	RX = Red B = Blue	L15: 28 mm x 26.75 mm - Common Cathode Package L11: 28 mm x 26.75 mm - Common Anode Package See Mechanical Drawing section	Refer to ordering part numbers in this document

Note 1: Flux Bin listed is minimum bin shipped, higher bins may be included at Luminus' discretion.

Binning Structure

All CBT-90 monochromatic LEDs are tested for luminous flux/ wavelength and placed into one of the following flux/ wave length bins. The binning structure is universally applied across each monochromatic color of the CBT-90 product line.

Flux Bins

Color	Luminous Flux Bin (FF) ³	Binning @ 13.5A, T _{hs} = 40°C ⁵	
		Minimum Flux/ Power	Maximum Flux/ Power
Red	BM	770 lm	970 lm
	BN	970 lm	1150 lm
	BP	1150 lm	1350 lm
	BQ	1350 lm	1570 lm
	BR	1570 lm	1850 lm
Blue	G	8.3 W	9.1 W
	H	9.1 W	10.0 W
	J	10.0 W	11.0 W
	K	11.0 W	12.1 W
	L	12.1 W	13.3 W
	M	13.3 W	14.6 W

Wavelength Bins

Color	Wavelength Bin ³	Binning @ 13.5A, T _{hs} = 40°C ⁵	
		Minimum Wavelength (nm)	Maximum Wavelength (nm)
Red (Dominant WL)	R2	611	615
	R3	615	619
	R4	619	623
	R5	623	627
	R6	627	631
Blue (Peak WL)	445	445	450
	450	450	455
	455	455	460
	460	460	465
	465	465	470

Note 1: Luminus maintains a +/- 6% tolerance on flux measurements.

Note 2: Products are production tested then sorted and packed by bin.

Note 3: Individual bins are not orderable. Please refer to the Product ordering information page for a list of orderable bin kits.

Note 4: Product test condition: 13.5A DC, 40°C heat sink temperature.

Note 5: T_{hs} = Testing Heat Sink Temperature.

Typical Device Performance

General Characteristics		Symbol	Red	Blue	Unit
Emitting Area			9.0	9.0	mm ²
Emitting Area Dimensions			3.0x3.0	3.0x3.0	mm x mm
Characteristics at Recommended Test Drive Current , I_f^{1,2,3}					
Reference Duty Cycle			100	100	%
Test Peak Drive Current	typ	I _F	13.5	13.5	A
Peak Luminous Flux ^{4,5,6}	typ	Φ _v	1250	630	lm
Peak Radiometric Flux ^{4,5,6}	typ	Φ _r	6.6	13	W
Dominant Wavelength ⁴	typ	λ _d	620	461	nm
Peak Wavelength ⁴	typ	λ _d	631	456	nm
FWHM- Spectral bandwidth at 50% of Φ _v ⁴	typ		20	21	nm
Chromaticity Coordinates ⁷	typ	x	0.694	0.146	
	typ	y	0.306	0.035	
Forward Voltage	min	V _{Fmin}	2	2.9	V
	typ	V _F	2.8	3.5	V
	max	V _{Fmax}	3.8	4.8	V
Dynamic Resistance	typ	Ω _{dyn}	0.03	0.02	Ω
Device Thermal Characteristics					
Thermal Coefficient of Photometric Flux	typ		-1	-0.08	% / °C
Thermal Coefficient of Radiometric Flux	typ		-0.7	-0.2	% / °C
Forward Voltage Temperature Coefficient	typ		-2.9	-3.75	mV/ °C

Absolute Maximum Ratings

	Symbol	Red	Blue	Unit
Absolute Minimum Current (CW or Pulsed) ^{8,9}		0.2	0.2	A
Absolute Maximum Current (CW) ¹⁰		27	27	A
Absolute Maximum Surge Current ¹⁰ (Frequency > 240 Hz, duty cycle =10%, t=1ms)		31.5	31.5	A
Absolute Maximum Junction Temperature ¹⁰	T _{jmax}	125	150	°C
Storage Temperature Range		-40/+100	-40/+100	°C

Note 1: All ratings are based on operation with a constant heat sink temperature $T_{hs} = 40^{\circ}\text{C}$. See Thermal Resistance section for T_{hs} definition.

Note 2: CBT-90-RX/B device can be driven at currents ranging from 200mA to 27A and at duty cycles ranging from 1% to 100%. Drive current and duty cycle should be adjusted as necessary to maintain the junction temperature desired to meet application lifetime requirements. In pulsed operation, rise time from 10-90% of forward current should be larger than 0.5 microseconds.

Note 3: Tested at Current Density of 1.5 A/mm².

Note 4: Unless otherwise noted, values listed are typical. Devices are production tested and specified at 13.5 A.

Note 5: Total flux from emitting area at listed wavelength. Reported performance is included to show trends for a selected power level. For specific minimum and maximum values, use bin tables. For product roadmap and future performance of devices, contact Luminus.

Note 6: Caution must be taken not to stare at the light emitted from these LEDs. Under special circumstances, the high intensity could damage the eye.

Note 7: In CIE 1931 chromaticity diagram coordinates, normalized to X+Y+Z=1.

Note 8: For reference only.

Note 9: Special design considerations must be observed for operation under 1 A. Please contact Luminus for further information.

Note 10: CBT-90-RX/B LED is designed for operation to an absolute maximum current and temperature as specified above. Product lifetime data is specified at recommended forward drive currents. Sustained operation at or beyond absolute maximum currents or temperatures will result in a reduction of device life ime compared to recommended conditions. Refer to the lifetime derating curves for further information.

Optical & Electrical Characteristics (Red)

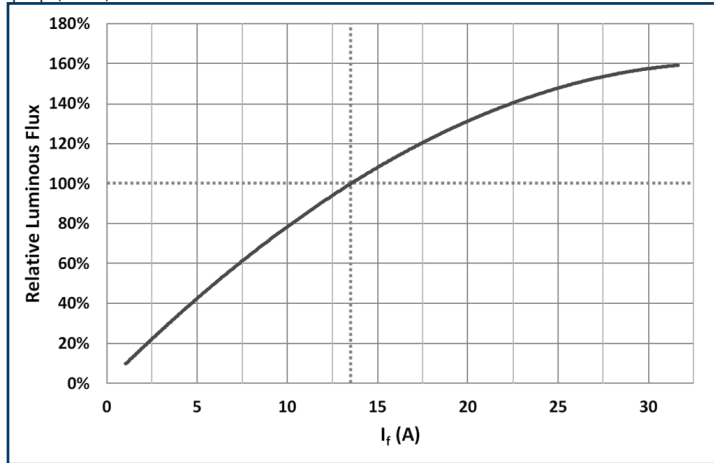
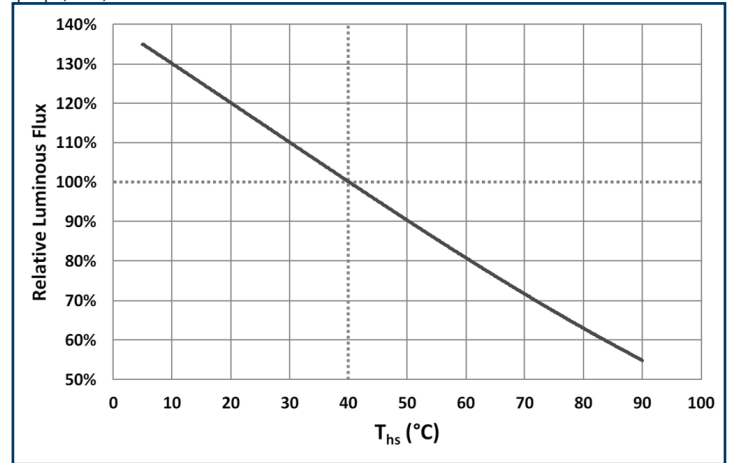
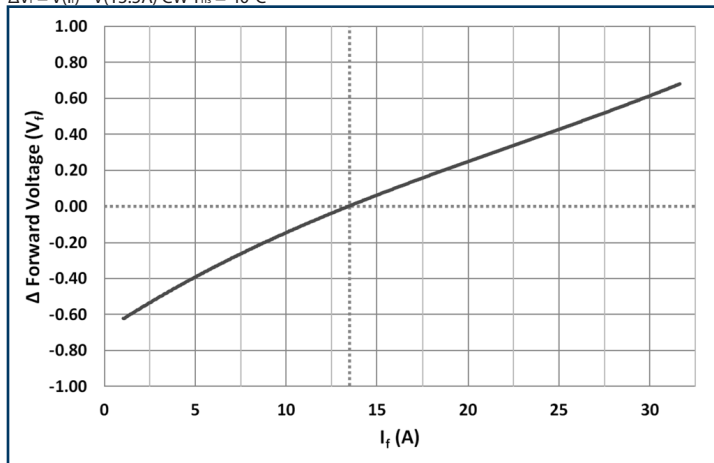
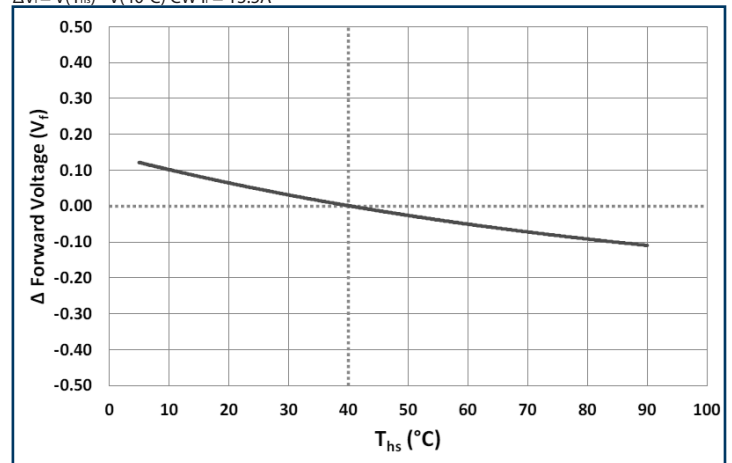
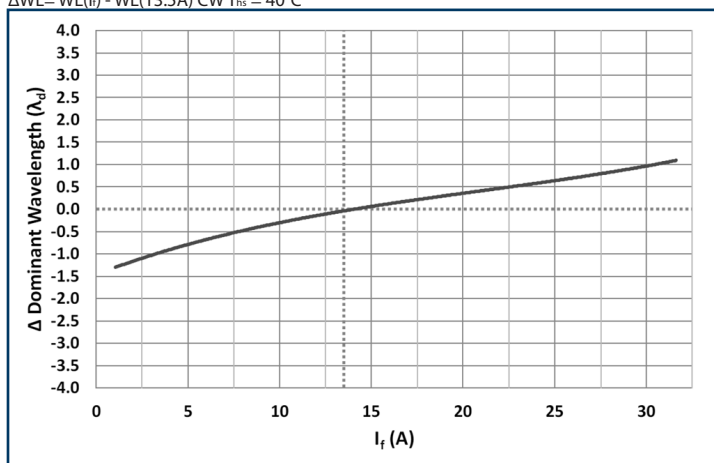
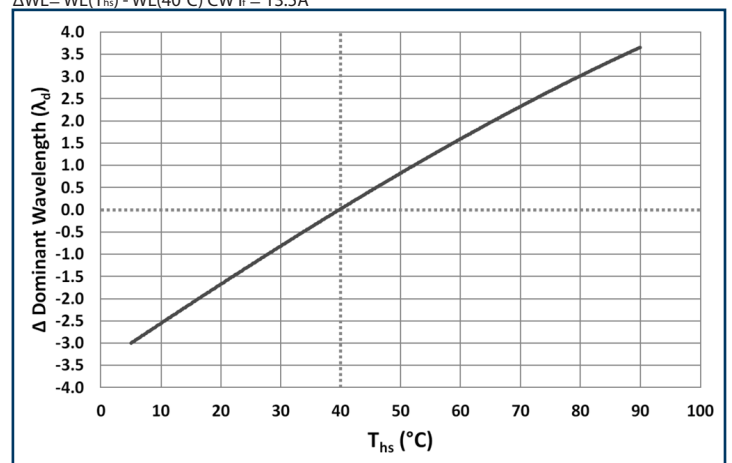
Relative Luminous Flux vs Forward Current
 $\phi_v/\phi_v(13.5A)$ CW $T_{hs} = 40^\circ C$

Relative Luminous Flux vs Temperature
 $\phi_v/\phi_v(40^\circ C)$ CW $I_f = 13.5A$

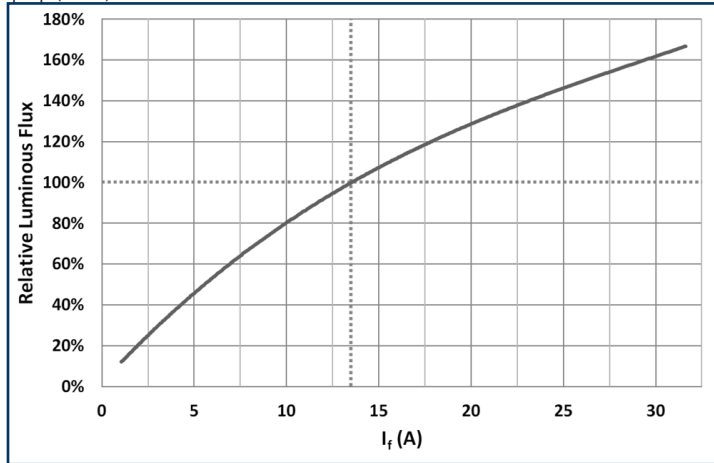
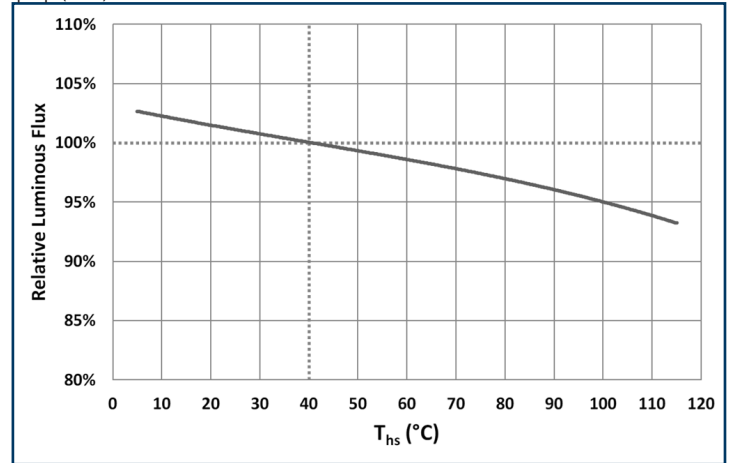
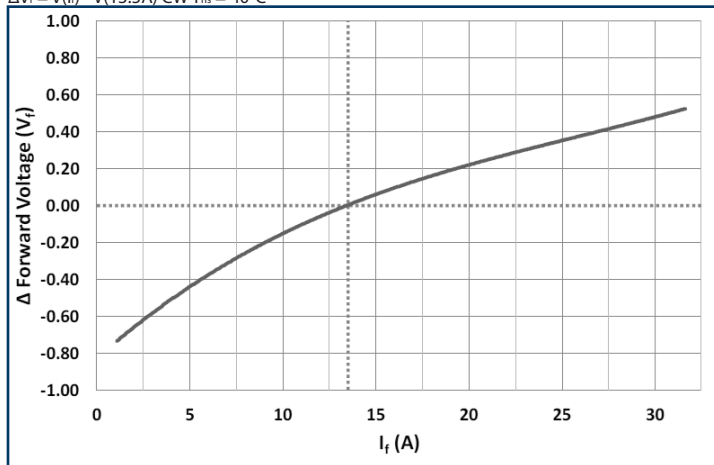
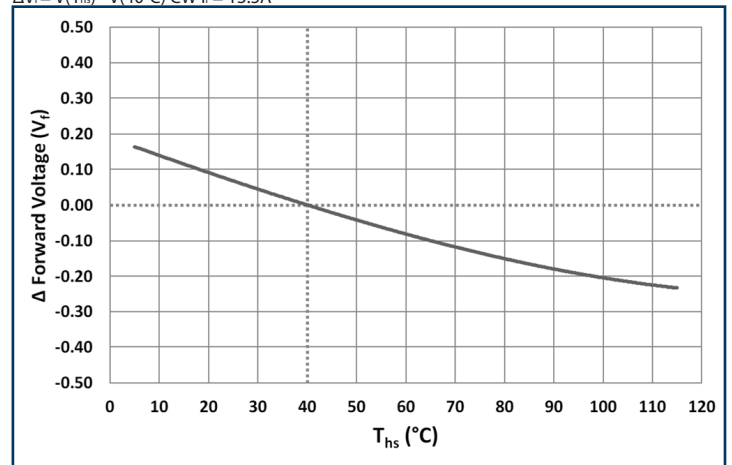
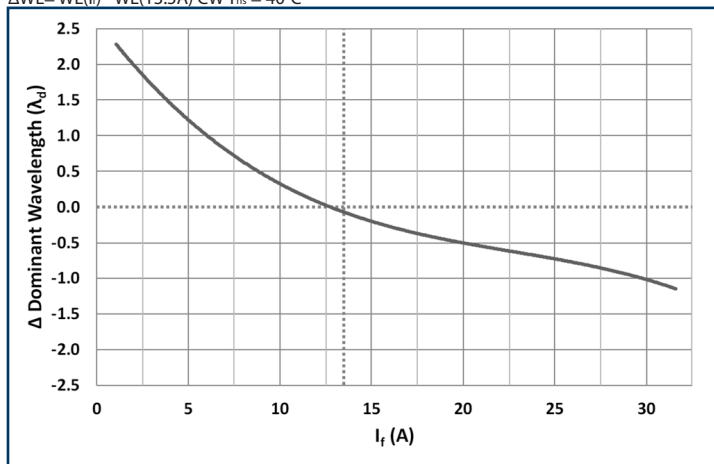
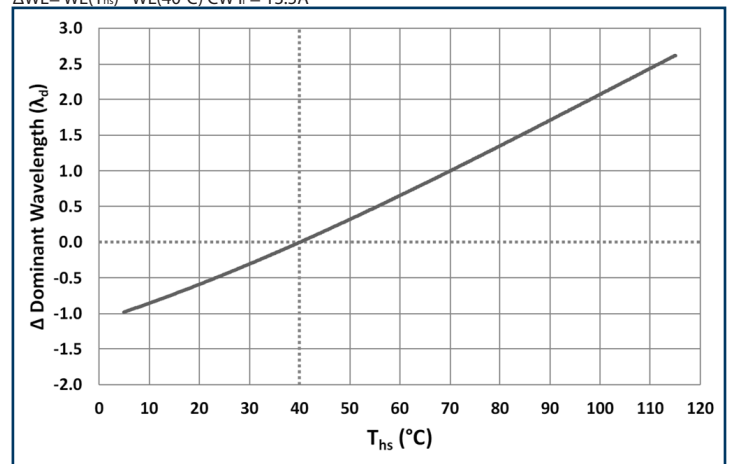
Relative Forward Voltage vs Forward Current
 $\Delta V_f = V(I_f) - V(13.5A)$ CW $T_{hs} = 40^\circ C$

Relative Forward Voltage vs Temperature
 $\Delta V_f = V(T_{hs}) - V(40^\circ C)$ CW $I_f = 13.5A$

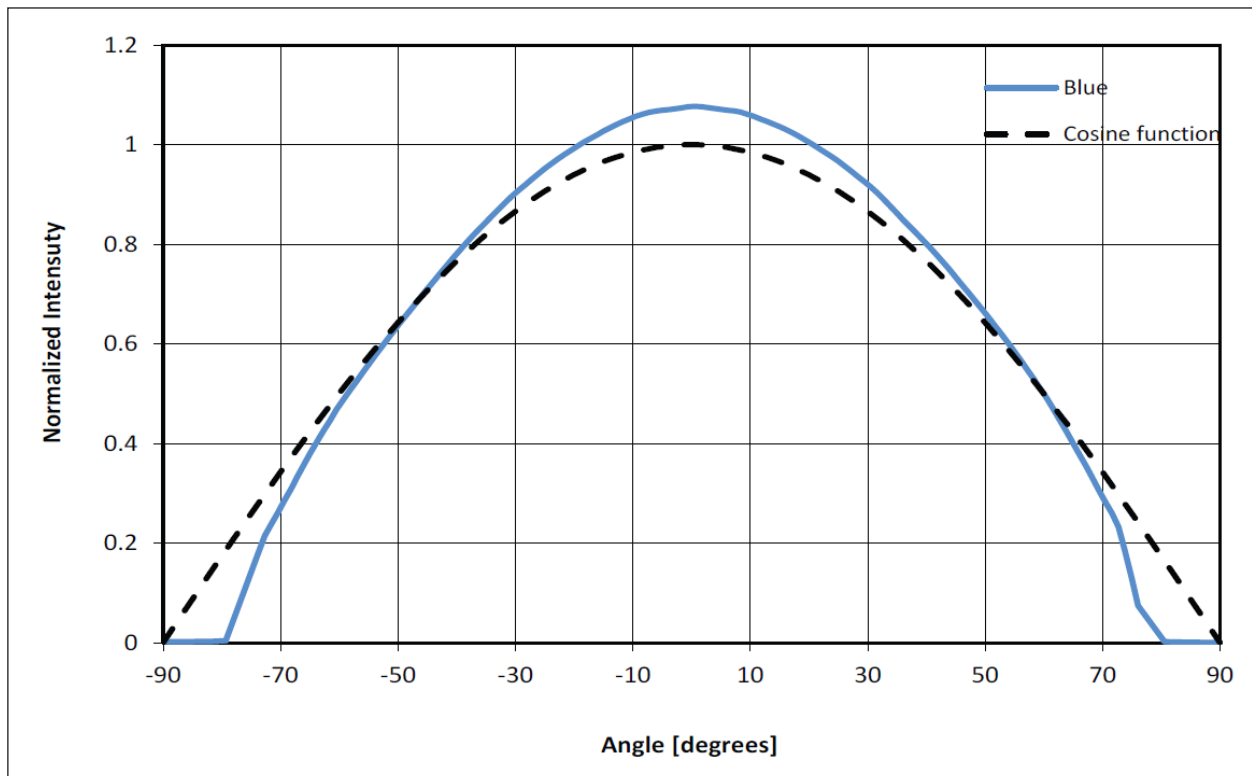
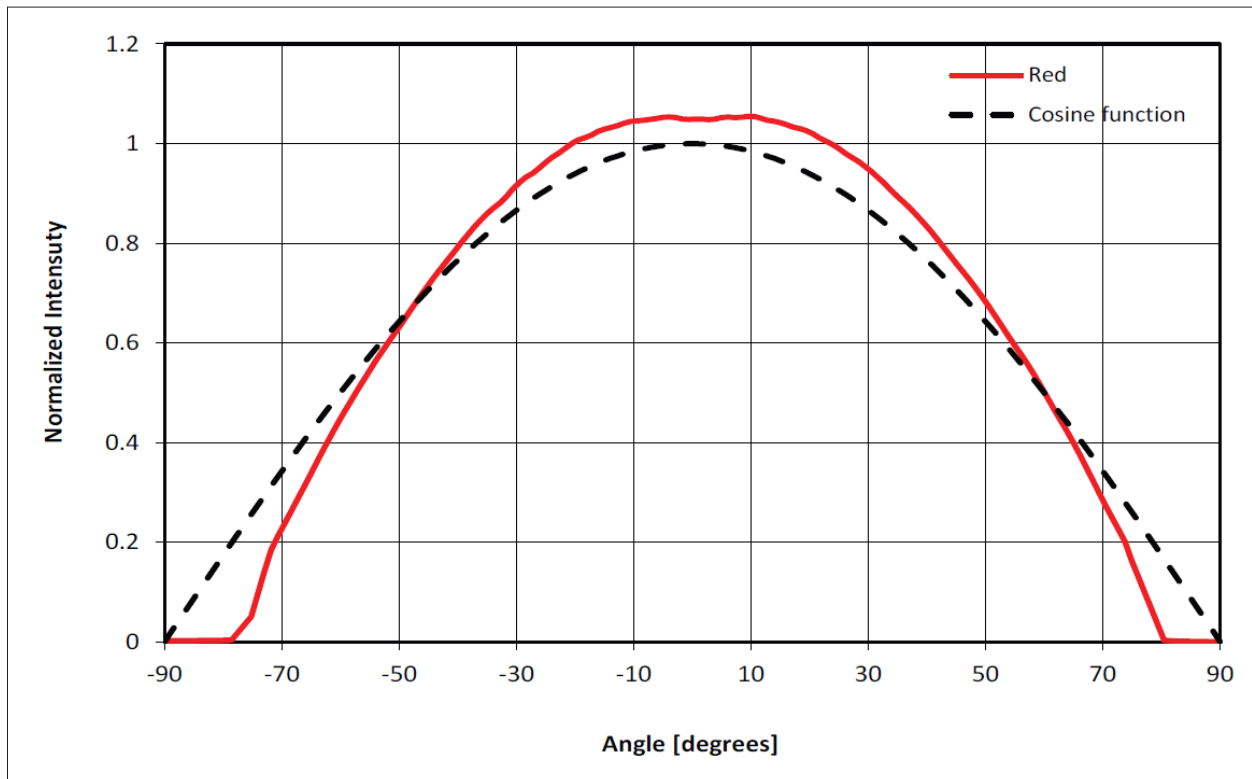
Dom Wavelength Shift vs Forward Current
 $\Delta WL = WL(I_f) - WL(13.5A)$ CW $T_{hs} = 40^\circ C$

Dom Wavelength Shift vs Temperature
 $\Delta WL = WL(T_{hs}) - WL(40^\circ C)$ CW $I_f = 13.5A$

Optical & Electrical Characteristics (Blue)

Relative Luminous Flux vs Forward Current
 $\phi_v/\phi_v(13.5A)$ CW $T_{hs} = 40^\circ C$

Relative Luminous Flux vs Temperature
 $\phi_v/\phi_v(40^\circ C)$ CW $I_f = 13.5A$

Relative Forward Voltage vs Forward Current
 $\Delta V_f = V_f(I_f) - V_f(13.5A)$ CW $T_{hs} = 40^\circ C$

Relative Forward Voltage vs Temperature
 $\Delta V_f = V_f(T_{hs}) - V_f(40^\circ C)$ CW $I_f = 13.5A$

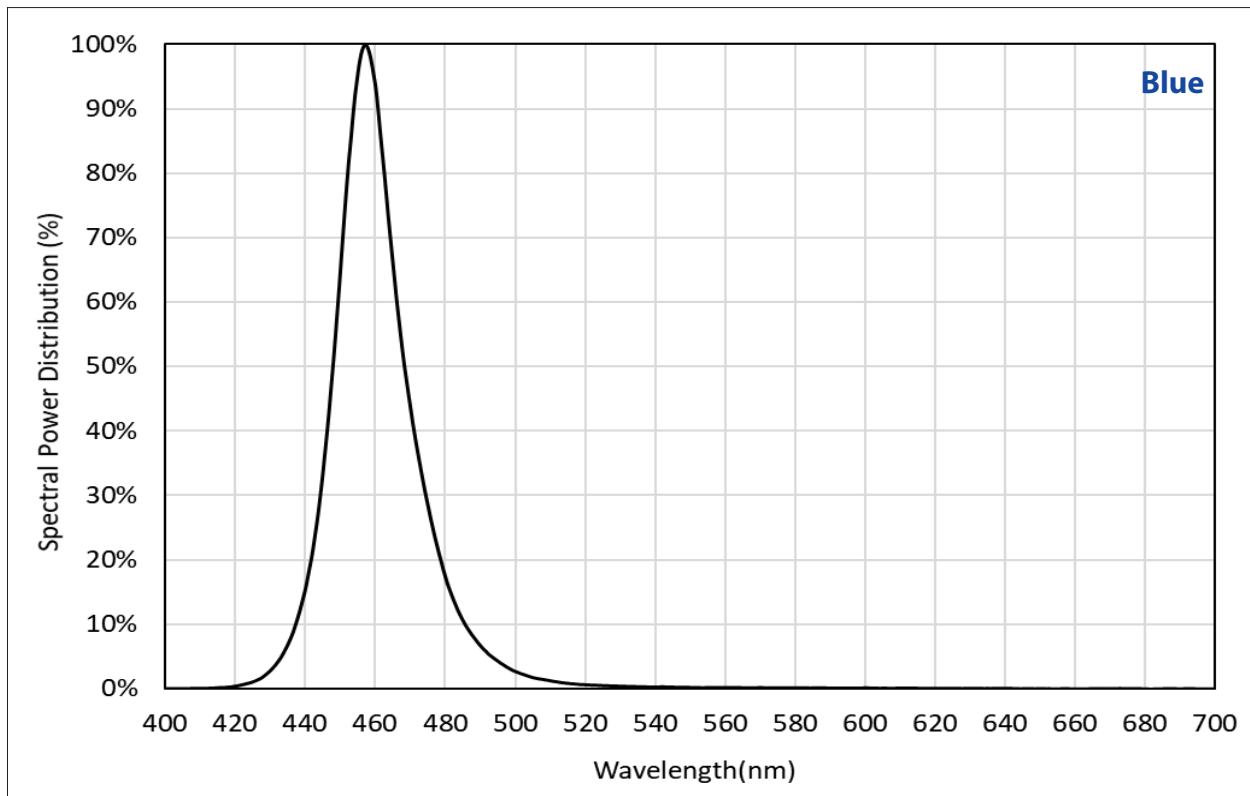
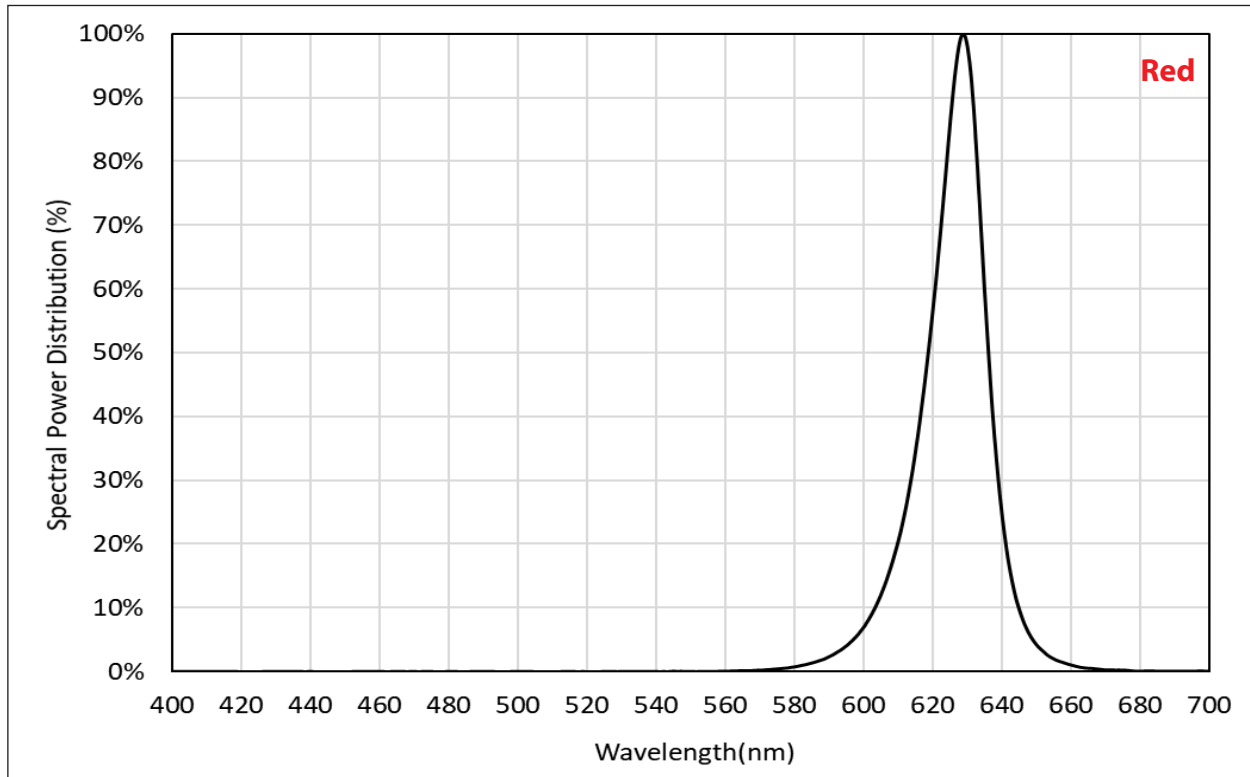
Dom Wavelength Shift vs Forward Current
 $\Delta WL = WL(I_f) - WL(13.5A)$ CW $T_{hs} = 40^\circ C$

Dom Wavelength Shift vs Temperature
 $\Delta WL = WL(T_{hs}) - WL(40^\circ C)$ CW $I_f = 13.5A$

Angular Intensity Distribution (Typical)



Typical Spectrum



Thermal Resistance

Typical Thermal Resistance

$R_{\theta j-b}^{-1}$	0.5 °C/W
$R_{\theta j-ref}^{-1}$	0.5 °C/W

Note 1: Thermal resistance measurements are in accordance with JEDEC 51-14.

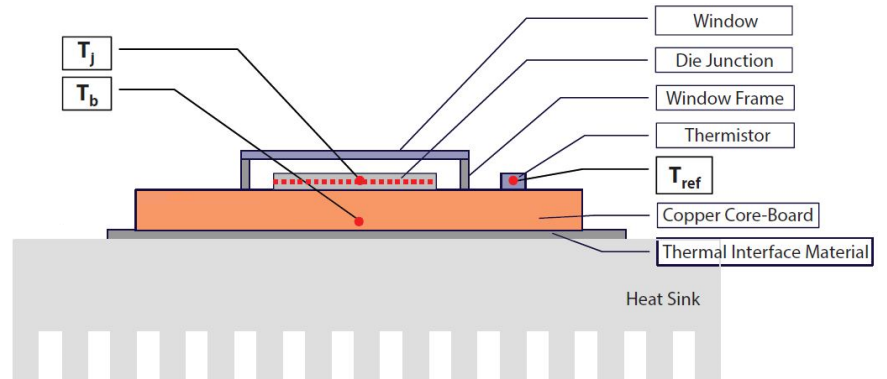

Thermistor Information

For more about calculating thermistor temperature, please see <https://7w4gu55aofsagtmy.anvil.app/S2C6EXFFQQ7SQYTBQ7MIUG2N>

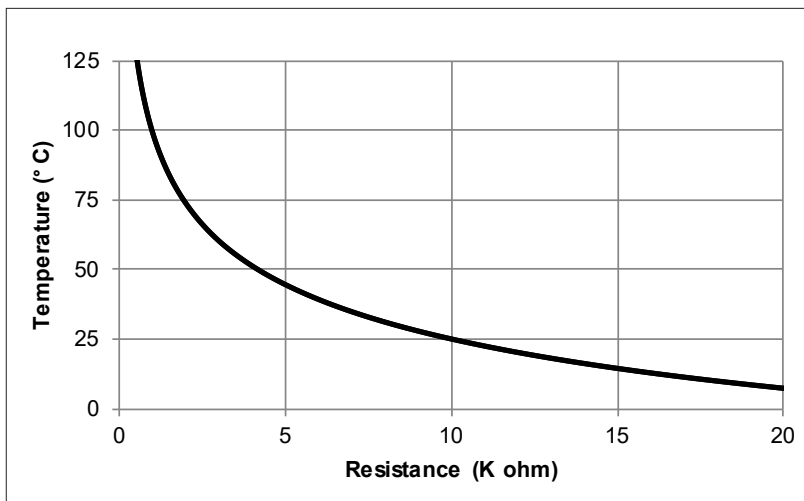

Electrical Pinout

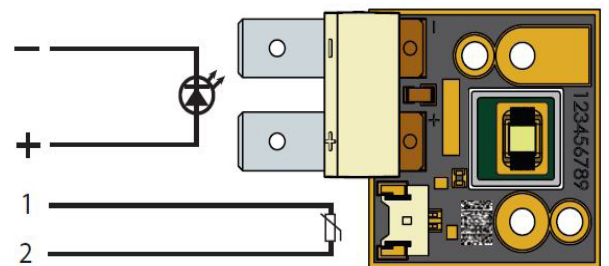

Mechanical Dimensions (Red)

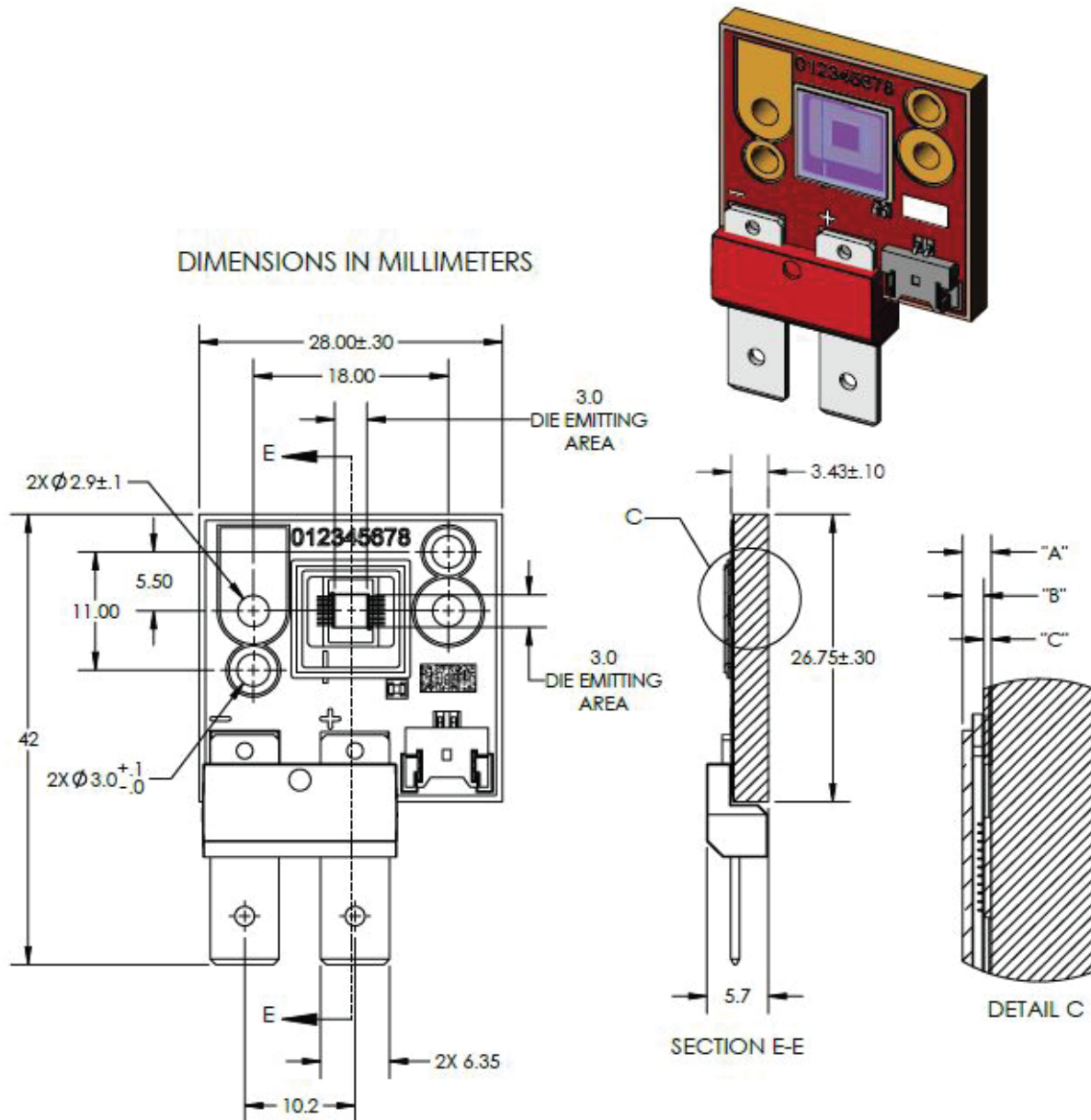

DIMENSION NAME	DESCRIPTION	NOMINAL DIMENSION	TOLERANCE
"A"	TOP OF METAL SUBSTRATE TO TOP OF WINDOW	.88	±.13
"B"	TOP OF DIE EMITTING AREA TO TOP OF WINDOW	.65	±.11
"C"	TOP OF METAL SUBSTRATE TO TOP OF DIE EMITTING AREA	.23	±.02

Recommended connector for Anode and Cathode:

Panduit Disco Lok™ Series P/N: DNF14-250FIB-C or JST Manufacturing Co: SPS-61T-250 for AWG 16 to 14

Panduit Disco Lok™ Series P/N: DNF10-250FIB-L or JST Manufacturing Co: SPS-91T-250 for AWG 12 to 10

(Check NEC standards for ampacity of the power cable being used)

Recommended Female: MOLEX P/N 51146-0200 (not recommended for new designs), GCT P/N WTB06-020H-A or equivalent

For detailed drawing please refer to DWG-002309 document

Mechanical Dimensions (Blue)



BLUE LED DEVICE

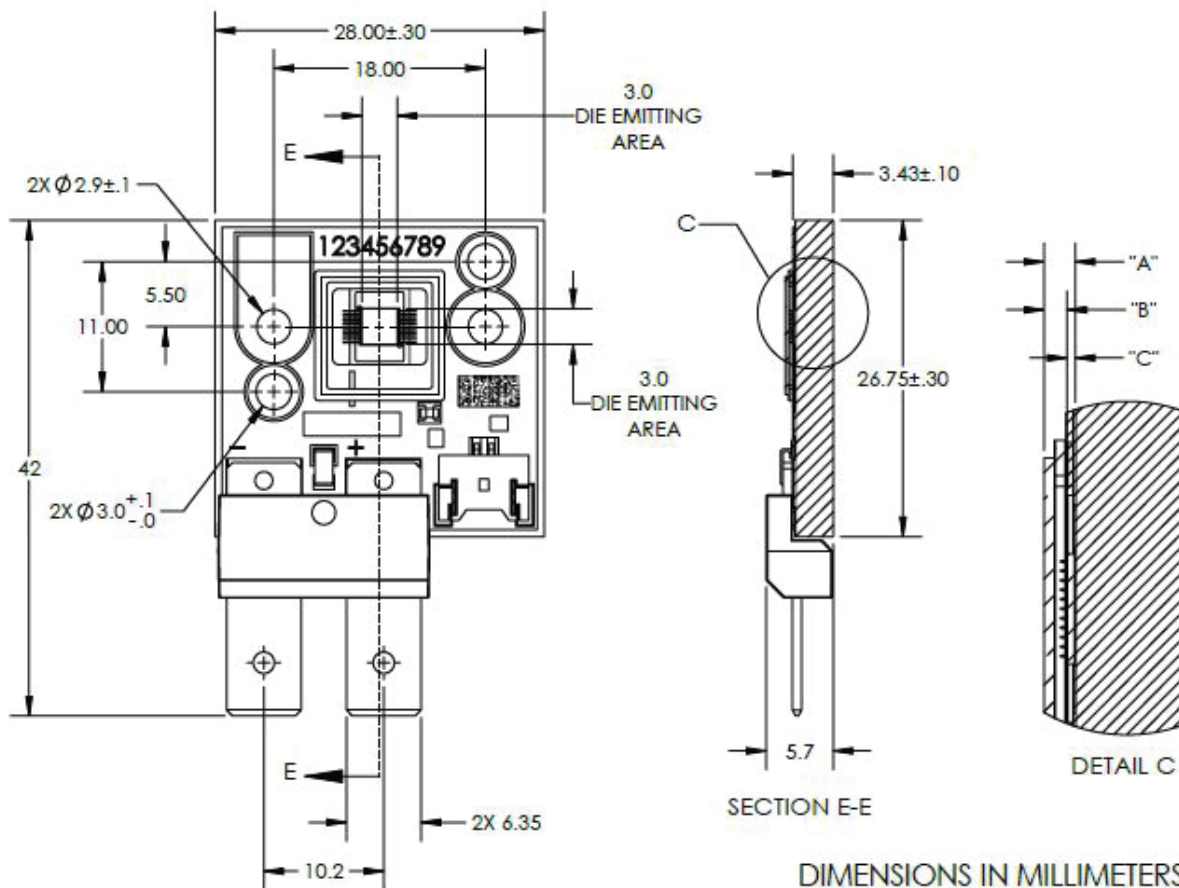

DIMENSION NAME	DESCRIPTION	NOMINAL DIMENSION	TOLERANCE
"A"	TOP OF METAL SUBSTRATE TO TOP OF WINDOW	.88	$\pm .13$
"B"	TOP OF DIE EMITTING AREA TO TOP OF WINDOW	.65	$\pm .11$
"C"	TOP OF METAL SUBSTRATE TO TOP OF DIE EMITTING AREA	.23	$\pm .02$

Recommended connector for Anode and Cathode:

Panduit Disco Lok™ Series P/N: DNF14-250FIB-C or JST Manufacturing Co: SPS-61T-250 for AWG 16 to 14

Panduit Disco Lok™ Series P/N: DNF10-250FIB-L or JST Manufacturing Co: SPS-91T-250 for AWG 12 to 10

(Check NEC standards for ampacity of the power cable being used)

Recommended Female: MOLEX P/N 51146-0200 (not recommended for new designs), GCT P/N WTB06-020H-A or equivalent

For detailed drawing please refer to DWG-002309 document

Shipping Tray Outline

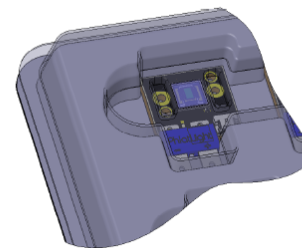
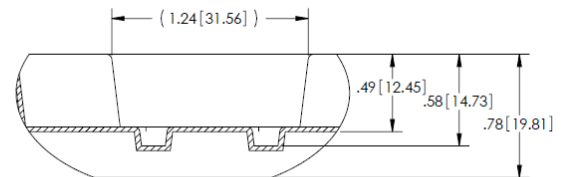
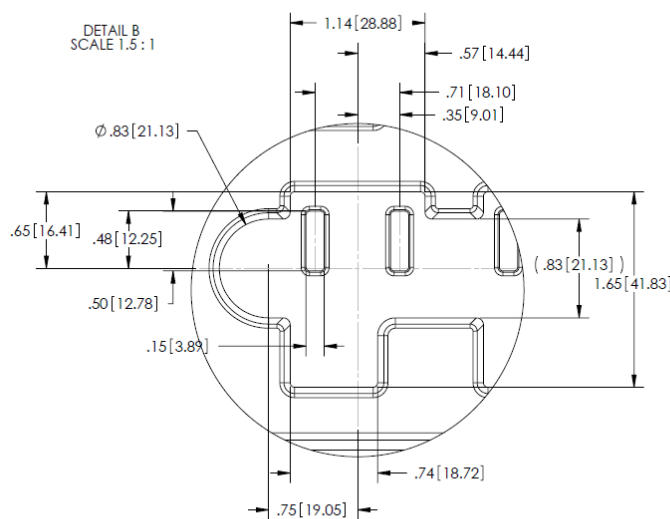
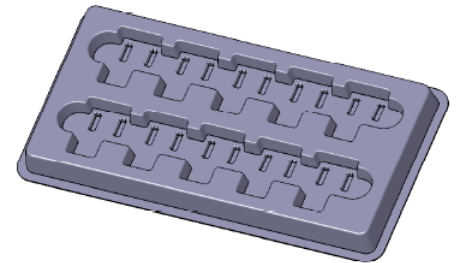
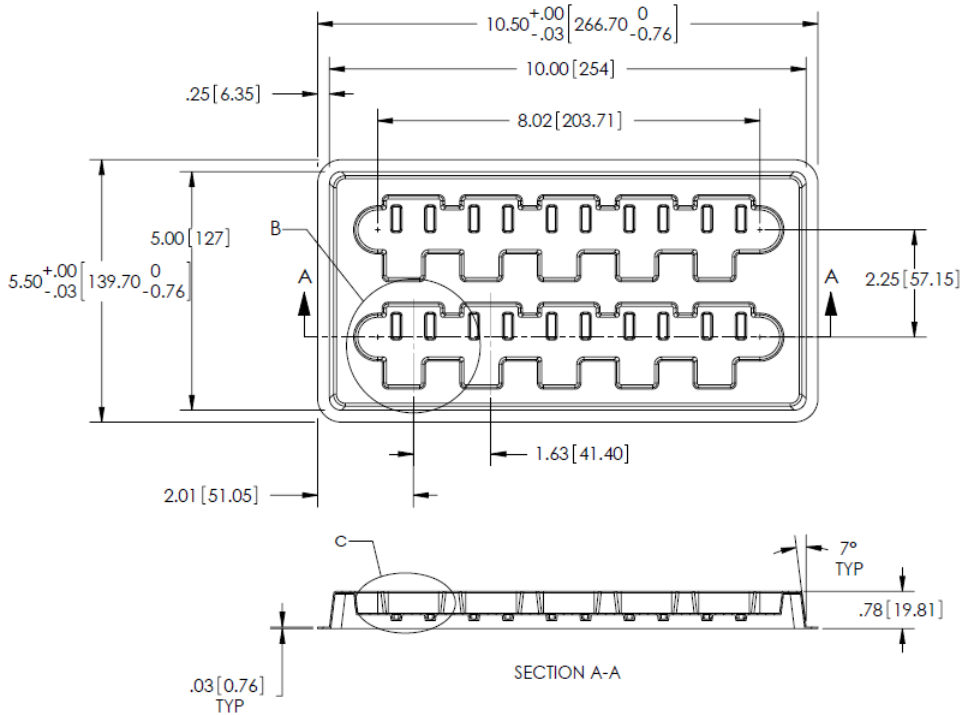

TOP TRAY SHOWN TRANSPARENT FOR REFERENCE ONLY

Shipping Label

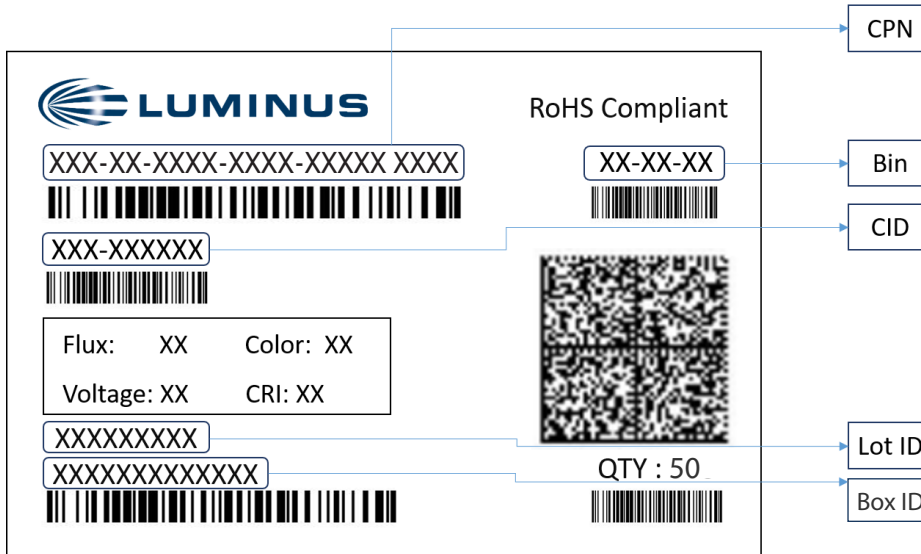

Label Fields:

- CPN: Luminus ordering part number
- CID: Customer's part number
- QTY: Quantity of devices in pack
- Flux: Bin as defined on page 4
- Voltage: NA
- Color: Bin as defined on page 5
- CRI: NA

Packing Configuration:

- Maximum: stack of 5 trays with 10 devices per tray per pack
- Partial pack or tray may be shipped
- Each pack is enclosed in antistatic bag
- Shipping label is placed on top of each pack

Revision History

Rev	Date	Description of Change
01	12/01/2015	Initial Release - Preliminary Specifications
02	02/09/2015	Editorial Changes and Update of Blue Bin Kit Offering
03	02/15/2015	Corrected Green Bin Kit Definition
04	06/17/2017	Revised wording in last page; Removed "Preliminary"
05	07/19/2017	Updated Red flux bin
06	08/03/2020	Updated optical and electrical graphs
07	12/01/2020	Updated maximum flux bins to support improved production output
08	05/10/2022	Rename PDS from CBT-90 TE to CBT-90-RX/B TE, remove CBT-90 Green information, update product photo, typical device performance, typical spectrum, thermal resistance, shipping information and add ESD information

Luminus Devices assumes no liability for errors that may appear in this document, and no liability otherwise arising from the application or use of the product or information contained herein. None of the information provided herein should be considered to be a representation of the fitness or suitability of the product for any particular application or as any other form of warranty. Luminus Devices' product warranties are limited to only such warranties as accompany a purchase contract or purchase order for such products. Nothing herein is to be construed as constituting an additional warranty. No information contained in this publication may be considered as a waiver by Luminus Devices of any intellectual property rights that Luminus Devices may have in such information.

This product is protected by U.S. Patents 6,831,302; 7,074,631; 7,083,993; 7,084,434; 7,098,589; 7,105,861; 7,138,666; 7,166,870; 7,166,871; 7,170,100; 7,196,354; 7,211,831; 7,262,550; 7,274,043; 7,301,271; 7,341,880; 7,344,903; 7,345,416; 7,348,603; 7,388,233; 7,391,059 Patents Pending in the U.S. and other countries.