



# u-blox cellular product overview

Powerful, easy-to-integrate, comprehensive cellular modules and chips

## Cellular modules for all kinds of applications

u-blox cellular modules optimize performance and cost, while supporting seamless technology transitions.



### SARA series

LTE-M, NB-IoT, and 2G  
LGA modules  
16.0 x 26.0 x 2.2-3.0 mm

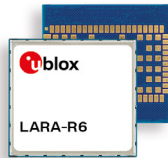

### LARA series

LTE Cat 1 and Cat 4  
LGA modules  
24.0 x 26.0 x 2.6 mm

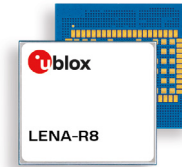

### LENA series

LTE Cat 1bis  
LGA modules  
27 x 30 x 2.6 mm

## Key features and benefits



### Market-specific differentiators

- Unique features for automotive, industrial, and consumer markets



### Technology designed for IoT

- Built to last an IoT lifetime: Long-term availability of integrated chipset platforms
- Secure by design: Industry-leading, foundational hardware and software security with proven and lightweight key management system
- Compatible with u-blox communication, location and security services



### Reduced system complexity

- Pin/pad compatible through nested design
- Seamless operation with u-blox GNSS and Wi-Fi / Bluetooth modules, along with flexibility to choose the best-suited module for specific applications
- Extensive set of features accessible via AT commands to simplify development
- Common AT commands simplify developing applications for multiple products



### Ecosystem enablement

- Broad portfolio of technologies provide great flexibility and top performance
- Comprehensive set of worldwide cellular certifications that increase scalability and reduce cost for IoT solutions

## Technology selection

IoT and automotive applications are very diverse. Different cellular technologies provide capabilities for a large variety of use cases. The comprehensive portfolio of u-blox cellular modules provides the right option for your product development:

	2G	3G	NB-IoT	LTE-M	LTE Cat 1	LTE Cat 4
<b>Data rate</b>	kb/s	Mb/s	kb/s	kb/s	10 Mb/s	150 Mb/s
<b>Low latency</b>	•	•		1	•	•
<b>Indoor / underground penetration</b>			•	2		
<b>Low power</b>			•	•		
<b>Voice</b>	•	•		3	•	3
<b>2G/3G fallback</b>				4	4	4

1 = Low latency if the device is not operating in PSM and eDRX

2 = Partly fulfilled: MCL GPRS -144 dB, LTE-M -155 dB, NB-IoT -164 dB



3 = Supported in a subsequent firmware version

4 = Variant dependent



## Why choose a u-blox cellular module?

As the world is becoming increasingly connected, cellular modules are critical components in the development of IoT devices and automotive communication hubs. They collect data from sensors, transmit it between connected objects and, in some cases, store data locally on devices deployed in the field. Choosing the right supplier to ensure a properly functioning, secure and sustainable module for your IoT or automotive application is an important business decision.

- 
**Financial stability and IPR protection**
  - Publicly traded on the Swiss stock exchange, providing transparency and guaranteeing quality and security
  - Full intellectual property indemnity based on FRAND for standard essential patents at the module level
- 
**First class technical support**
  - Highly responsive and competent support teams with strong technical know-how
  - Global technical support network with local support through all stages of development
  - Extensive technical documentation
  - Evaluation kits and application boards for design testing with minimal resources
- 
**High quality and reliability**
  - Lowest ppm level during customer production and in the field
  - Very short delivery time due to multiple well-stocked locations
  - Stringent product change notification process with advanced notification
  - In-house reliability and test equipment
  - Zero defect strategy, e.g. testing of functions within tolerance, X-ray inspection

## GNSS integration

u-blox's unrivalled core competencies in cellular and positioning technologies bring strong synergies, as both are often required together in today's sophisticated applications.

**External GNSS:** Provides utmost flexibility to choose GNSS features, accuracy, and sensitivity. GNSS-related commands are tunneled, allowing the host processor to fully control both subsystems through single serial interface and user-friendly AT commands.



**Integrated GNSS:** Modules based on u-blox cellular chipsets include u-blox M8/M10 GNSS reception, delivering high performance satellite positioning alongside cellular data connectivity.

## Chipset integration

Modules based on our chipsets are not dependent on third parties and are focused on IoT-specific feature development. This translates into long-term availability, roadmap stability, and technical support down to the silicon level.

- Designed to last an IoT lifetime: Long-term availability of the platform
- Excellent customer support: down to a chip level, thanks to the u-blox R5 core
- Unique and IoT-focused services: via access to low-level chip data

## Product grades

	 <b>Standard grade</b>	 <b>Professional grade</b>	 <b>Automotive grade</b>
<b>Environmental conditions</b>	Consumer environment	Industrial environment	Automotive environment
<b>Temperature</b>	-20 °C to +65 °C	-40 °C to +85 °C	-40 °C to +85 °C or extended (up to +105 °C on some products)
<b>Product qualification</b>	JESD47 (ICs) Subset of AEC-Q104 non-biased (modules)	AEC-Q100 (ICs) u-blox policy / sub-set of AEC-Q104 (modules)	AEC-Q100 (ICs) AEC-Q104 (modules)
<b>Process levels for design, manufacturing, and testing</b>	<ul style="list-style-type: none"> <li>• 100% outgoing test</li> <li>• Product traceability</li> <li>• PCN process</li> <li>• Failure analysis</li> </ul>	Standard grade, plus: <ul style="list-style-type: none"> <li>• 100% automatic X-ray and optical inspection of modules</li> </ul>	Professional grade, plus: <ul style="list-style-type: none"> <li>• PPAP, automotive test flow, ISO/TS 16949 manufacturing, component traceability, 8D failure reporting, automotive PCN process, long product life cycles, 0-ppm program</li> </ul>



## Form factors, technologies, and regions

For each module variant, the main and fallback technologies are shown in the regions where they are to be used.

Modules	EMEA					North America					South America					APAC				
	G	U	N	R	L	G	U	N	R	L	G	U	N	R	L	G	U	N	R	L
SARA-R500S-01B			•	•				•	•				•	•				•	•	
SARA-R500S-61B								•	•									J	J	
SARA-R510S-01B			•	•				•	•				•	•				•	•	
SARA-R510S-61B								•	•									J	J	
SARA-R510M8S-01B			•	•				•	•				•	•				•	•	
SARA-R510M8S-61B								•	•									J	J	
SARA-R510M8S-71B																		K	K	
SARA-R540S			•	•				•	•				•	•				•	•	
SARA-R510AWS				•				•					•						•	
SARA-R500E								•												
SARA-R422	•		•	•		•	•	•		•	•	•		•	•	•	Δ	•	•	
SARA-R422S	•		•	•		•	•	•		•	•	•		•	•	•	Δ	•	•	
SARA-R422M10S	•		•	•		•	•	•		•	•	•		•	•	•	Δ	•	•	
SARA-N310			•									•						•		
LARA-L6004	•	•			•	•	•			•	•	•		•	•		•	•		•
LARA-L6004D	•	•			•	•	•			•	•	•		•	•		•	•		•
LARA-L6404D										•										
LARA-R6001	•	•		•		•	•	•		•	•	•		•	•	•	Δ	•	•	
LARA-R6001D	•	•		•		•	•	•		•	•	•		•	•	•	Δ	•	•	
LARA-R6401								•												
LARA-R6401D								•												
LARA-R6801	•	•		•						•	•	•		•	•	•	Δ	•	•	
LENA-R8001	•			•		•		◦		•		•		•		•	Δ		•	
LENA-R8001M10	•			•		•		◦		•		•		•		•	Δ		•	
SARA-G450	•									•								Δ		

**Legend:**

- G** = GSM/GPRS
- U** = UMTS/HSPA
- N** = NB-IoT
- R** = LTE-M, LTE Cat 1
- L** = LTE Cat 4
- = Main technology
- = Fallback technology
- = LTE Cat1 bis with supported roaming but not certified by MNOs
- Δ = GSM/GPRS in APAC, but not supported in Japan or Korea
- ◆ = Special firmware version for Japan and Korea is available for some variants; refer to product documentation
- J = Japan only
- K = Korea only

For a detailed view of our cellular product offering, see our overview here:

[www.u-blox.com/cellular-modules](http://www.u-blox.com/cellular-modules)

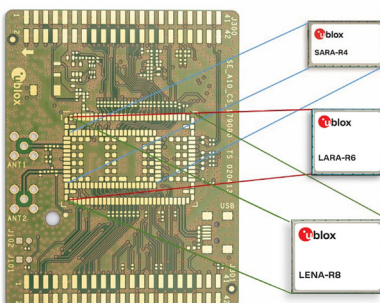

### Nested design

Thanks to u-blox nested design, alternate modules can be mounted on the same PCB space as assembly options. This allows a single PCB design to be retrofitted with GSM, HSPA, NB-IoT, or LTE u-blox technologies, thus enabling a straightforward migration between cellular technologies and module generations. This in turn protects the customer's development investment.

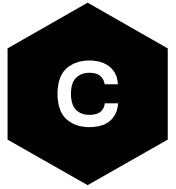

## Secure by design



### Robust

- Commercially hardened Root of Trust is the foundation of advanced security functionality in modules containing a secure element
- Lightweight, scalable, and proven key management system, ideal for high-volume LPWA deployments
- Latest (D)TLS stack and cipher suites with hardware-based crypto acceleration



### Efficient

- Reduced data overhead in (D)TLS communications, resulting in lower power consumption
- Support of IoT Security-as-a-Service: Design Security, End-to-end Security, and Certificate Lifecycle Control



### Time-to-market

- Deploy more rapidly by minimizing integration efforts and removing the need for an external crypto chip, while reducing device size and saving component costs
- Eliminate the need to develop your own certificate delivery solution with out-of-the-box Zero Touch Provisioning to the most widely used IoT cloud platforms and your servers

## u-blox cellular product naming

u-blox cellular modules are available in different form factors and variants to provide flexibility for scaling different cellular technologies to various application and geographical requirements, such as band support, cost, performance, and level of component integration.

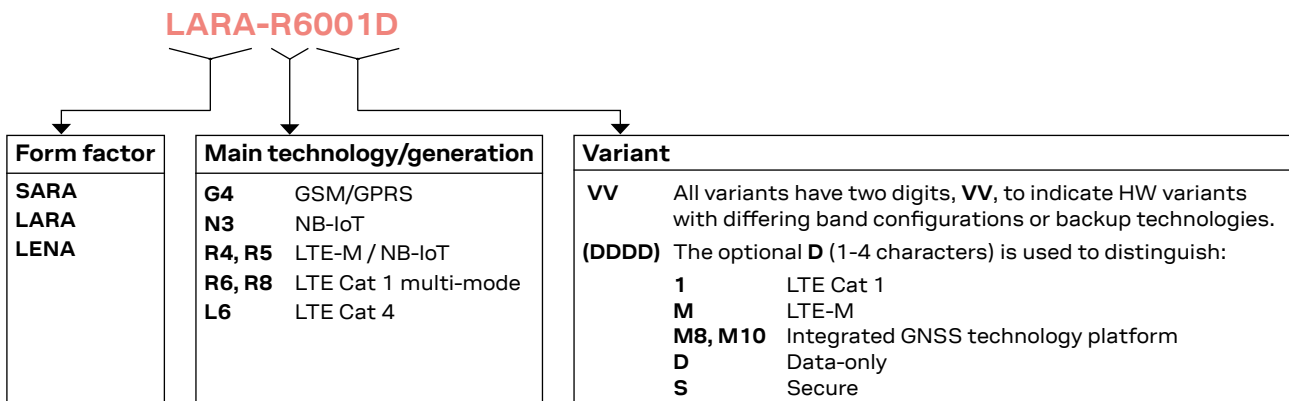

## u-blox values and promise



### Competent technical support worldwide

- Over 20 years of R&D in GNSS technology
- Lifetime support and maximum competence



### Quick time to market

- Short and reliable delivery times
- Module form factor consistency



### High quality

- Global leader in positioning and wireless communication
- In-house chip technology



### Broad spectrum of solutions

- Strong synergies between technologies: Wi-Fi, Bluetooth, cellular, positioning
- Hardware, software, services, and solutions



### Security

- End-to-end data protection from device to end-user
- Symmetric key management and integrated root of trust

## Further information

For contact information, see [www.u-blox.com/contact-u-blox](http://www.u-blox.com/contact-u-blox).

For more product details and ordering information, see the individual product data sheets.

## Legal Notice:

u-blox or third parties may hold intellectual property rights in the products, names, logos and designs included in this document. Copying, reproduction, or modification of this document or any part thereof is only permitted with the express written permission of u-blox. Disclosure to third parties is permitted for clearly public documents only.

The information contained herein is provided "as is". No warranty of any kind, either express or implied, is made in relation to the accuracy, reliability, fitness for a particular purpose or content of this document. This document may be revised by u-blox at any time. For most recent documents, please visit [www.u-blox.com](http://www.u-blox.com).