

# ZED-F9T

## u-blox F9 high accuracy timing module

### Data sheet

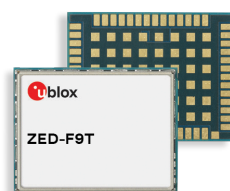

### Abstract

This data sheet describes the ZED-F9T timing module with multi-band GNSS receiver and nanosecond-level timing accuracy. ZED-F9T meets the most stringent 5G timing requirements, is ideal for global deployment due to GPS, BeiDou, Galileo, and GLONASS reception, and is unaffected by ionospheric errors. The module provides differential timing mode for highly accurate local timing and built-in security for highest robustness against malicious attacks.

# Document information

<b>Title</b>	<b>ZED-F9T</b>	
<b>Subtitle</b>	u-blox F9 high accuracy timing module	
<b>Document type</b>	Data sheet	
<b>Document number</b>	UBX-20033635	
<b>Revision and date</b>	R06	07-Jan-2022
<b>Document status</b>	Early production information	
<b>Disclosure restriction</b>	C1-Public	

<b>Product status</b>	<b>Corresponding content status</b>	
<b>In development / prototype</b>	Objective specification	Target values. Revised and supplementary data will be published later.
<b>Engineering sample</b>	Advance information	Data based on early testing. Revised and supplementary data will be published later.
<b>Initial production</b>	Early production information	Data from product verification. Revised and supplementary data may be published later.
<b>Mass production / End of life</b>	Production information	Document contains the final product specification.

This document applies to the following products:

<b>Product name</b>	<b>Type number</b>	<b>Firmware version</b>	<b>PCN reference</b>
ZED-F9T	ZED-F9T-10B-01	TIM 2.20	UBX-21050800

u-blox or third parties may hold intellectual property rights in the products, names, logos and designs included in this document. Copying, reproduction, modification or disclosure to third parties of this document or any part thereof is only permitted with the express written permission of u-blox.

The information contained herein is provided "as is" and u-blox assumes no liability for its use. No warranty, either express or implied, is given, including but not limited to, with respect to the accuracy, correctness, reliability and fitness for a particular purpose of the information. This document may be revised by u-blox at any time without notice. For the most recent documents, visit [www.u-blox.com](http://www.u-blox.com).

Copyright © 2022, u-blox AG.

# Contents

<b>1 Functional description.....</b>	<b>4</b>
1.1 Overview.....	4
1.2 Performance.....	4
1.3 Supported GNSS constellations.....	5
1.4 Supported GNSS augmentation systems.....	5
1.4.1 Quasi-Zenith Satellite System (QZSS).....	5
1.4.2 Satellite based augmentation system (SBAS).....	6
1.4.3 Differential timing mode.....	6
1.5 Broadcast navigation data and satellite signal measurements.....	6
1.5.1 Carrier-phase measurements.....	6
1.6 Supported protocols.....	6
<b>2 System description.....</b>	<b>8</b>
2.1 Block diagram.....	8
<b>3 Pin definition.....</b>	<b>9</b>
3.1 Pin assignment.....	9
<b>4 Electrical specification.....</b>	<b>12</b>
4.1 Absolute maximum ratings.....	12
4.2 Operating conditions.....	12
4.3 Indicative power requirements.....	13
<b>5 Communications interfaces.....</b>	<b>14</b>
5.1 UART.....	14
5.2 SPI.....	14
5.3 I2C.....	15
5.4 USB.....	17
5.5 Default interface settings.....	17
<b>6 Mechanical specification.....</b>	<b>18</b>
<b>7 Reliability tests and approvals.....</b>	<b>19</b>
7.1 Approvals.....	19
<b>8 Labeling and ordering information.....</b>	<b>20</b>
8.1 Product labeling.....	20
8.2 Explanation of product codes.....	20
8.3 Ordering codes.....	20
<b>Related documents.....</b>	<b>21</b>
<b>Revision history.....</b>	<b>22</b>

# 1 Functional description

## 1.1 Overview

The ZED-F9T is a multi-band GNSS module offering 5 ns (1-sigma) timing accuracy with unparalleled low power consumption.

The ZED-F9T incorporates the u-blox F9 multi-band platform in a small surface-mount device with a form factor of 22 x 17 mm.

## 1.2 Performance

Parameter	Specification	
Receiver type	Multi-band GNSS receiver for timing applications	
Accuracy of time pulse signal <sup>1</sup>	Absolute timing mode	5 ns
	Differential timing mode <sup>2</sup>	2.5 ns
Frequency of time pulse signal	0.25 Hz to 25 MHz (configurable)	
Time pulse jitter	±4 ns	
Time-mark resolution	8 ns	
Operational limits <sup>3</sup>	Dynamics	≤ 4 g
	Altitude	80,000 m
	Velocity	500 m/s
Velocity accuracy <sup>4</sup>	0.05 m/s	
Dynamic heading accuracy <sup>4</sup>	0.3 deg	

GNSS		GPS+GLO+GAL+BDS	GPS+BDS+GAL	GPS+GAL	GPS+GLO	GPS+BDS	GPS
Acquisition <sup>5</sup>	Cold start	24 s	25 s	29 s	26 s	28 s	29 s
	Hot start	2 s	2 s	2 s	2 s	2 s	2 s
	Aided start <sup>6</sup>	2 s	2 s	2 s	2 s	2 s	2 s
Nav. update rate <sup>7</sup>		8 Hz	10 Hz	15 Hz	15 Hz	12 Hz	20 Hz

**Table 1: ZED-F9T performance in different GNSS modes**

GNSS		GPS+GLO+GAL+BDS	GPS+BDS+GAL	GPS+GAL	GPS+GLO	GPS+BDS	GPS
Horizontal pos. accuracy	Standalone <sup>8</sup>	1.5 m CEP	1.5 m CEP	1.5 m CEP	1.5 m CEP	1.5 m CEP	1.5 m CEP

**Table 2: ZED-F9T position accuracy in different GNSS modes**

<sup>1</sup> 1-sigma, fixed position mode, depends on temperature, atmospheric conditions, baseline length, GNSS antenna, multipath conditions, satellite visibility and geometry

<sup>2</sup> Demonstrated with 20 km baseline

<sup>3</sup> Assuming Airborne 4 g platform

<sup>4</sup> 50% at 30 m/s for dynamic operation

<sup>5</sup> Commanded starts. All satellites at -130 dBm. Measured at room temperature.

<sup>6</sup> Dependent on the speed and latency of the aiding data connection, commanded starts

<sup>7</sup> 95% In PVT navigation mode, assumes secondary navigation output disabled (default)

<sup>8</sup> Depends on atmospheric conditions, GNSS antenna, multipath conditions, satellite visibility, and geometry



In order to achieve the maximum timing accuracy, it is recommended to measure the propagation delay of the entire signal path from the antenna to the receiver's time pulse output, and then compensate for this delay using the CFG-TP configuration items.

GNSS	GPS+GLO+GAL+BDS	
Sensitivity <sup>9</sup>	Tracking and nav.	-167 dBm
	Reacquisition	-160 dBm
	Cold start	-148 dBm
	Hot start	-157 dBm

Table 3: ZED-F9T sensitivity

## 1.3 Supported GNSS constellations

The ZED-F9T GNSS modules are concurrent GNSS receivers that can receive and track multiple GNSS systems. Owing to the multi-band RF front-end architecture, all four major GNSS constellations (GPS, Galileo, GLONASS and BeiDou) plus NavIC, SBAS and QZSS satellites can be received concurrently. If low power consumption is a key factor, then the receiver can be configured for a subset of GNSS constellations.

The ZED-F9T can receive the NavIC L5 satellite signals that share the same frequency with GPS L5 signals and can be configured to work singly or in parallel with the other GNSS constellations.

The QZSS system shares the same frequency bands as GPS and can only be processed in conjunction with GPS.

To benefit from multi-band signal reception, dedicated hardware preparation must be made during the design-in phase. See the integration manual [1] for u-blox design recommendations.

The ZED-F9T supports the GNSS and their signals as shown in Table 4.

GPS / QZSS	GLONASS	Galileo	BeiDou	NavIC
L1C/A (1575.420 MHz)	L1OF (1602 MHz + k*562.5 kHz, k = -7,...,6)	E1-B/C (1575.420 MHz)	B1I (1561.098 MHz) B1C (1575.42MHz) <sup>10</sup>	-
L5 (1176.450 MHz)	-	E5a (1176.450 MHz)	B2a (1176.450 MHz)	SPS-L5 (1176.450 MHz)

Table 4: Supported GNSS and signals on ZED-F9T

The ZED-F9T can use the u-blox AssistNow™ Online service which provides GNSS assistance information.

## 1.4 Supported GNSS augmentation systems

### 1.4.1 Quasi-Zenith Satellite System (QZSS)

The Quasi-Zenith Satellite System (QZSS) is a regional navigation satellite system that provides positioning services for the Pacific region covering Japan and Australia. The ZED-F9T is able to receive and track QZSS L1 C/A and L5 signals concurrently with GPS signals, resulting in better availability especially under challenging signal conditions, e.g., in urban canyons.

<sup>9</sup> Demonstrated with a good external LNA. Measured at room temperature.

<sup>10</sup> B1I and B1C not to be enabled concurrently

 QZSS can be enabled only if GPS operation is also configured.

### 1.4.2 Satellite based augmentation system (SBAS)

The ZED-F9T supports SBAS (including WAAS in the US, EGNOS in Europe, MSAS in Japan and GAGAN in India) to deliver improved location accuracy within the regions covered. However, the additional inter-standard time calibration step used during SBAS reception results in degraded time accuracy overall.

 SBAS reception is disabled by default in ZED-F9T.

### 1.4.3 Differential timing mode

To improve timing accuracy locally, the ZED-F9T can be used in differential timing mode, in which correction data is sent to neighboring ZED-F9T timing receivers via a communication network.

In differential timing mode the ZED-F9T can operate either as a reference station generating the following RTCM 3.3 messages, or as a corrected station using the following RTCM 3.3 messages:

Message type	Description
RTCM 1005	Stationary RTK reference station ARP
RTCM 1077	GPS MSM7
RTCM 1087	GLONASS MSM7
RTCM 1097	Galileo MSM7
RTCM 1127	BeiDou MSM7
RTCM 1230	GLONASS code-phase biases
RTCM 4072.1	Additional reference station information (u-blox proprietary RTCM Message)

**Table 5: Supported RTCM 3.3 messages**

## 1.5 Broadcast navigation data and satellite signal measurements

The ZED-F9T can output all the GNSS broadcast data upon reception from tracked satellites. This includes all the supported GNSS signals plus the augmentation services QZSS and SBAS. The UBX-RXM-SFRBX message is used for this information. The receiver also makes available the tracked satellite signal information, i.e. raw code phase and Doppler measurements, in a form aligned to the Radio Resource LCS Protocol (RRLP) [3]. For the UBX-RXM-SFRBX message specification, see the interface description [2].

### 1.5.1 Carrier-phase measurements

The ZED-F9T modules provide raw carrier-phase data for all supported signals, along with pseudorange, Doppler and measurement quality information. The data contained in the UBX-RXM-RAWX message follows the conventions of a multi-GNSS RINEX 3 observation file. For the UBX-RXM-RAWX message specification, see interface description [2].

 Raw measurement data are available once the receiver has established data bit synchronization and time-of-week.

## 1.6 Supported protocols

The ZED-F9T supports the following protocols:

Protocol	Type
UBX	Input/output, binary, u-blox proprietary
NMEA 4.11 (default), 4.10, 4.0, 2.3, and 2.1	Input/output, ASCII
RTCM 3.3	Input/output, binary

**Table 6: Supported protocols**

For specification of the protocols, see the interface description [\[2\]](#).

## 2 System description

### 2.1 Block diagram

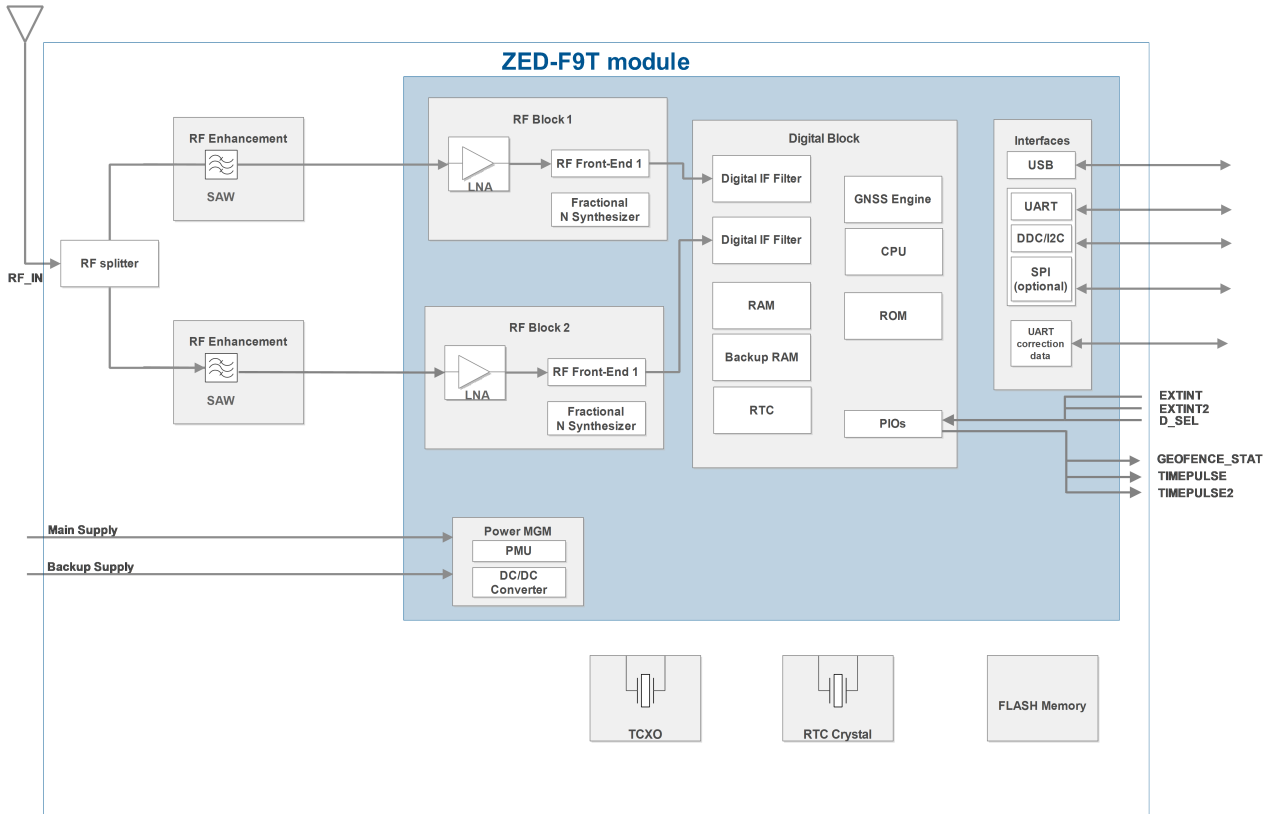

Figure 1: ZED-F9T block diagram



An active antenna is mandatory with the ZED-F9T. See the integration manual [1].



## 3 Pin definition

### 3.1 Pin assignment

The pin assignment of the ZED-F9T module is shown in [Figure 2](#). The defined configuration of the PIOs is listed in [Table 7](#).

For detailed information on pin functions and characteristics, see the ZED-F9T Integration manual [1].



The ZED-F9T is an LGA package with the I/O on the outside edge and central ground pads.

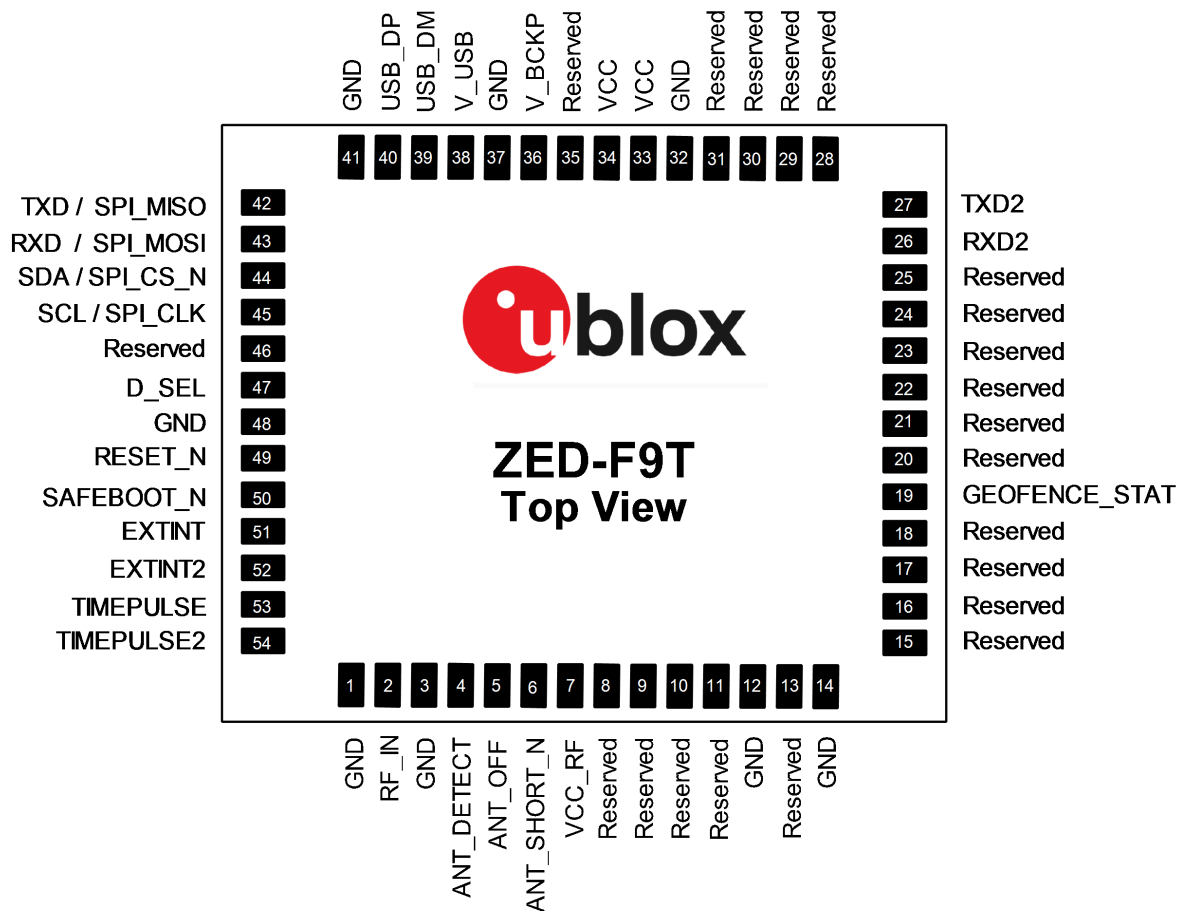

Figure 2: ZED-F9T pin assignment

Pin no.	Name	I/O	Description
1	GND	-	Ground
2	RF_IN	I	RF input
3	GND	-	Ground
4	ANT_DETECT	I	Active antenna detect - default active high
5	ANT_OFF	O	External LNA disable - default active high
6	ANT_SHORT_N	I	Active antenna short detect - default active low
7	VCC_RF	O	Voltage for external LNA

Pin no.	Name	I/O	Description
8	Reserved	-	Reserved
9	Reserved	-	Reserved
10	Reserved	-	Reserved
11	Reserved	-	Reserved
12	GND	-	Ground
13	Reserved	-	Reserved
14	GND	-	Ground
15	Reserved	-	Reserved
16	Reserved	-	Reserved
17	Reserved	-	Reserved
18	Reserved	-	Reserved
19	GEOFENCE_STAT	O	Geofence status, user defined
20	Reserved	-	Reserved
21	Reserved	-	Reserved
22	Reserved	-	Reserved
23	Reserved	-	Reserved
24	Reserved	-	Reserved
25	Reserved	-	Reserved
26	RXD2	I	Correction UART input
27	TXD2	O	Correction UART output
28	Reserved	-	Reserved
29	Reserved	-	Reserved
30	Reserved	-	Reserved
31	Reserved	-	Reserved
32	GND	-	Ground
33	VCC	I	Voltage supply
34	VCC	I	Voltage supply
35	Reserved	-	Reserved
36	V_BCKP	I	Backup supply voltage
37	GND	-	Ground
38	V_USB	I	USB supply
39	USB_DM	I/O	USB data
40	USB_DP	I/O	USB data
41	GND	-	Ground
42	TXD / SPI_MISO	O	Host UART output if D_SEL = 1 (or open). SPI_MISO if D_SEL = 0
43	RXD / SPI_MOSI	I	Host UART input if D_SEL = 1 (or open). SPI_MOSI if D_SEL = 0
44	SDA / SPI_CS_N	I/O	I2C Data if D_SEL = 1 (or open). SPI Chip Select if D_SEL = 0
45	SCL / SPI_CLK	I/O	I2C Clock if D_SEL = 1 (or open). SPI Clock if D_SEL = 0
46	Reserved	-	Reserved
47	D_SEL	I	Interface select for pins 42-45
48	GND	-	Ground
49	RESET_N	I	RESET_N
50	SAFEBOOT_N	I	SAFEBOOT_N (for future service, updates and reconfiguration, leave OPEN)
51	EXTINT	I	External Interrupt Pin

Pin no.	Name	I/O	Description
52	EXTINT2	I	External Interrupt Pin 2
53	TIMEPULSE	O	Time pulse
54	TIMEPULSE2	O	Time pulse 2

**Table 7: ZED-F9T pin assignment**

## 4 Electrical specification



The limiting values given are in accordance with the Absolute Maximum Rating System (IEC 134). Stress above one or more of the limiting values may cause permanent damage to the device. These are stress ratings only. Operation of the device at these or at any other conditions above those given below is not implied. Exposure to limiting values for extended periods may affect device reliability.



Where application information is given, it is advisory only and does not form part of the specification.

### 4.1 Absolute maximum ratings

Parameter	Symbol	Condition	Min	Max	Units
Power supply voltage	VCC		-0.5	3.6	V
Voltage ramp on VCC <sup>11</sup>			20	8000	µs/V
Backup battery voltage	V_BCKP		-0.5	3.6	V
Voltage ramp on V_BCKP <sup>11</sup>			20		µs/V
Input pin voltage	V <sub>in</sub>	VCC ≤ 3.1 V	-0.5	VCC + 0.5	V
		VCC > 3.1 V	-0.5	3.6	V
VCC_RF output current	ICC_RF			100	mA
Supply voltage USB	V_USB		-0.5	3.6	V
USB signals	USB_DM, USB_DP		-0.5	V_USB + 0.5 V	
Input power at RF_IN	Pr <sub>fin</sub>	source impedance = 50 Ω, continuous wave		10	dBm
Storage temperature	T <sub>stg</sub>		-40	+85	°C

**Table 8: Absolute maximum ratings**



The product is not protected against overvoltage or reversed voltages. Voltage spikes exceeding the power supply voltage specification, given in the table above, must be limited to values within the specified boundaries by using appropriate protection diodes.

### 4.2 Operating conditions



All specifications are at an ambient temperature of 25 °C. Extreme operating temperatures can significantly impact the specification values. Applications operating near the temperature limits should be tested to ensure the specification.

Parameter	Symbol	Min	Typical	Max	Units	Condition
Power supply voltage	VCC	2.7	3.0	3.6	V	
Backup battery voltage	V_BCKP	1.65		3.6	V	
Backup battery current	I_BCKP		36		µA	V_BCKP = 3 V, VCC = 0 V
SW backup current	I_SWBCKP		1.4		mA	
Input pin voltage range	V <sub>in</sub>	0		VCC	V	
Digital IO pin low level input voltage	V <sub>il</sub>			0.4	V	
Digital IO pin high level input voltage	V <sub>ih</sub>	0.8 * VCC			V	
Digital IO pin low level output voltage	V <sub>ol</sub>			0.4	V	I <sub>ol</sub> = 2 mA

<sup>11</sup> Exceeding the ramp speed may permanently damage the device

Parameter	Symbol	Min	Typical	Max	Units	Condition
Digital IO pin high level output voltage	Voh	VCC - 0.4			V	Ioh = 2 mA
DC current through any digital I/O pin (except supplies)	Ipin			5	mA	
VCC_RF voltage	VCC_RF		VCC - 0.1		V	
VCC_RF output current	ICC_RF			50	mA	
Receiver chain noise figure <sup>12</sup>	NFtot		9.5		dB	
External gain (at RF_IN)	Ext_gain	17		50	dB	
Operating temperature	Topr	-40	+25	85	°C	

**Table 9: Operating conditions**

Operation beyond the specified operating conditions can affect device reliability.

### 4.3 Indicative power requirements

Table 10 lists examples of the total system supply current including RF and baseband section for a possible application.



Values in Table 10 are provided for customer information only, as an example of typical current requirements. The values are characterized on samples by using a cold start command. Actual power requirements can vary depending on FW version used, external circuitry, number of satellites tracked, signal strength, type and time of start, duration, and conditions of test.

Symbol	Parameter	Conditions	GPS+GLO +GAL+BDS	GPS	Unit
I <sub>PEAK</sub>	Peak current	Acquisition	130	120	mA
I <sub>VCC</sub> <sup>13</sup>	VCC current	Acquisition	90	75	mA
I <sub>VCC</sub> <sup>13</sup>	VCC current	Tracking	85	68	mA

**Table 10: Currents to calculate the indicative power requirements**

All values in Table 10 are measured at 25 °C ambient temperature.

<sup>12</sup> Only valid for the GPS

<sup>13</sup> Simulated GNSS signal

## 5 Communications interfaces

There are several communications interfaces, including UART, SPI, I2C<sup>14</sup> and USB.

All the inputs have internal pull-up resistors in normal operation and can be left open if not used. All the PIOs are supplied by VCC, therefore all the voltage levels of the PIO pins are related to VCC supply voltage.

### 5.1 UART

The UART interfaces support configurable baud rates. See the Integration manual [1].

Hardware flow control is not supported.

The UART1 is enabled if D\_SEL pin of the module is left open or "high".

Symbol	Parameter	Min	Max	Unit
R <sub>u</sub>	Baud rate	9600	921600	bit/s
Δ <sub>Tx</sub>	Tx baud rate accuracy	-1%	+1%	-
Δ <sub>Rx</sub>	Rx baud rate tolerance	-2.5%	+2.5%	-

**Table 11: ZED-F9T UART specifications**

### 5.2 SPI

The ZED-F9T has an SPI slave interface that can be selected by setting D\_SEL = 0. The SPI slave interface is shared with UART1 and I2C pins. The SPI pins available are:

- SPI\_MISO (TXD)
- SPI\_MOSI (RXD)
- SPI\_CS\_N
- SPI\_CLK

The SPI interface is designed to allow communication to a host CPU. The interface can be operated in slave mode only. Note that SPI is not available in the default configuration because its pins are shared with the UART and I2C interfaces. The maximum transfer rate using SPI is 125 kB/s and the maximum SPI clock frequency is 5.5 MHz.

This section provides SPI timing values for the ZED-F9T slave operation. The following tables present timing values under different capacitive loading conditions. Default SPI configuration is CPOL = 0 and CPHA = 0.

<sup>14</sup> I2C is a registered trademark of Philips/NXP

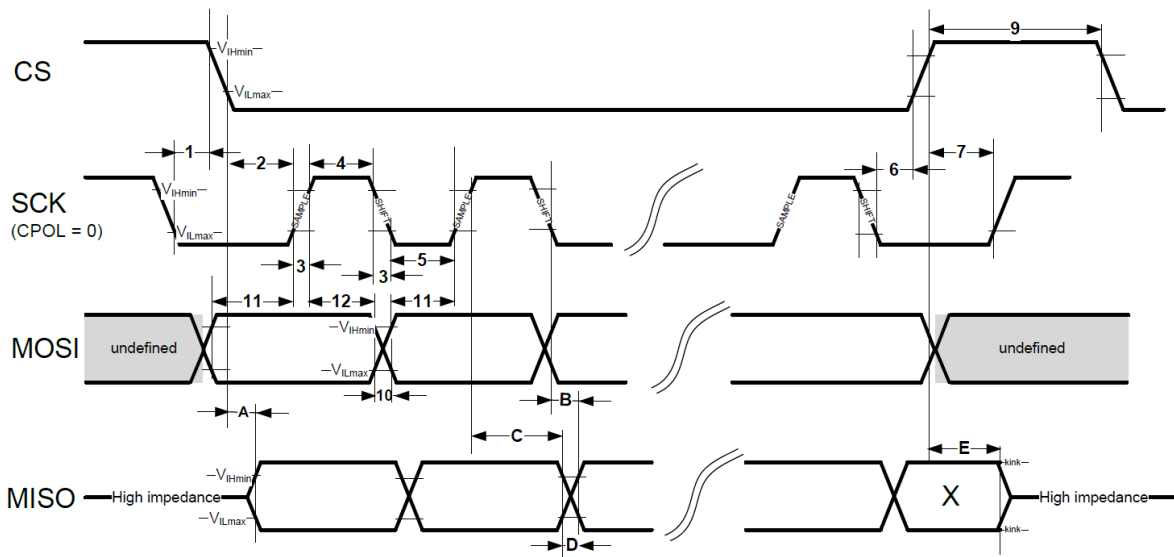
**Figure 3: ZED-F9T SPI specification mode 1: CPHA=0 SCK = 5.33 MHz**

Timings 1 - 12 are not specified here as they are dependent on the SPI master. Timings A - E are specified for SPI slave.

Timing value at 2 pF load	Min (ns)	Max (ns)
"A" - MISO data valid time (CS)	14	38
"B" - MISO data valid time (SCK) weak driver mode	21	38
"C" - MISO data hold time	114	130
"D" - MISO rise/fall time, weak driver mode	1	4
"E" - MISO data disable lag time	20	32

**Table 12: ZED-F9T SPI timings at 2 pF load**

Timing value at 20 pF load	Min (ns)	Max (ns)
"A" - MISO data valid time (CS)	19	52
"B" - MISO data valid time (SCK) weak driver mode	25	51
"C" - MISO data hold time	117	137
"D" - MISO rise/fall time, weak driver mode	6	16
"E" - MISO data disable lag time	20	32

**Table 13: ZED-F9T SPI timings at 20 pF load**

Timing value at 60 pF load	Min (ns)	Max (ns)
"A" - MISO data valid time (CS)	29	79
"B" - MISO data valid time (SCK) weak driver mode	35	78
"C" - MISO data hold time	122	152
"D" - MISO rise/fall time, weak driver mode	15	41
"E" - MISO data disable lag time	20	32

**Table 14: ZED-F9T SPI timings at 60 pF load**

## 5.3 I2C

An I2C-compliant interface is available for communication with an external host CPU. The interface can be operated in slave mode only. It is compatible with the I2C industry standard fast mode. Since

the maximum SCL clock frequency is 400 kHz, the maximum bit rate is 400 kbit/s. The interface stretches the clock when slowed down while serving interrupts, therefore the real bit rates may be slightly lower. The maximum clock stretching time that the host can expect is 20 ms.



The I2C interface is only available with the UART default mode. If the SPI interface is selected by using  $D\_SEL = 0$ , the I2C interface is not available.

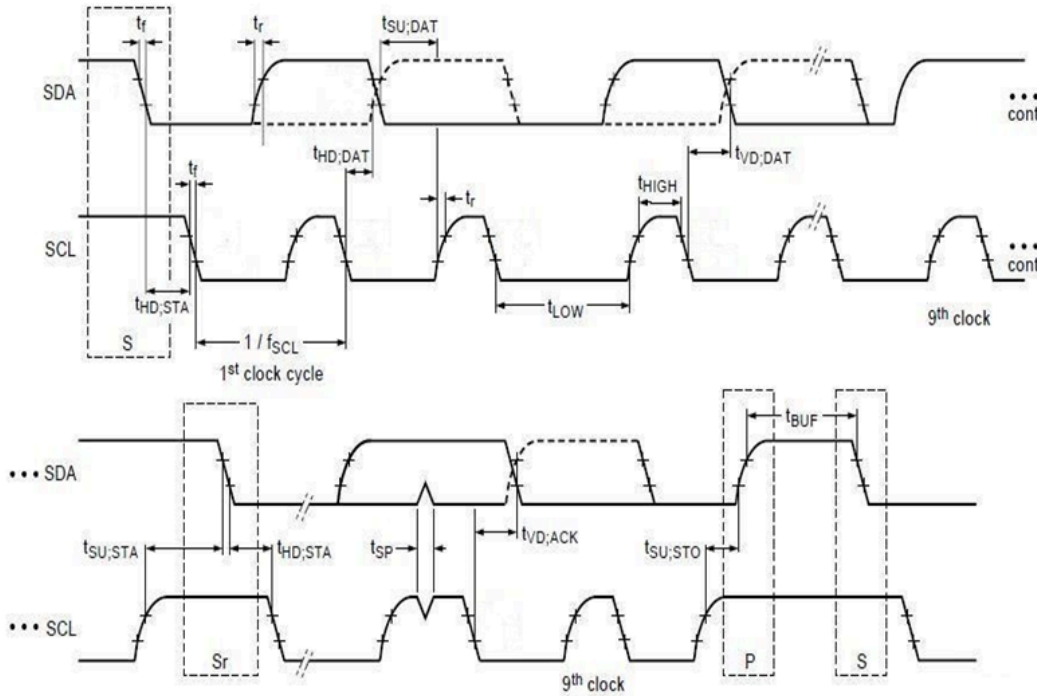

Figure 4: ZED-F9T I2C slave specification

Symbol	Parameter	Min (Standard / Fast mode)	Max	Unit
$f_{SCL}$	SCL clock frequency	0	400	kHz
$t_{HD;STA}$	Hold time (repeated) START condition	4.0/1	-	$\mu s$
$t_{LOW}$	Low period of the SCL clock	5/2	-	$\mu s$
$t_{HIGH}$	High period of the SCL clock	4.0/1	-	$\mu s$
$t_{SU;STA}$	Set-up time for a repeated START condition	5/1	-	$\mu s$
$t_{HD;DAT}$	Data hold time	0/0	-	$\mu s$
$t_{SU;DAT}$	Data set-up time	250/100	-	ns
$t_r$	Rise time of both SDA and SCL signals	-	1000/300 (for C = 400pF)	ns
$t_f$	Fall time of both SDA and SCL signals	-	300/300 (for C = 400pF)	ns
$t_{SU;STO}$	Set-up time for STOP condition	4.0/1	-	$\mu s$
$t_{BUF}$	Bus-free time between a STOP and START condition	5/2	-	$\mu s$
$t_{VD;DAT}$	Data valid time	-	4/1	$\mu s$
$t_{VD;ACK}$	Data valid acknowledge time	-	4/1	$\mu s$
$V_{nL}$	Noise margin at the low level	0.1 VCC	-	V
$V_{nH}$	Noise margin at the high level	0.2 VCC	-	V

Table 15: ZED-F9T I2C slave timings and specifications



## 5.4 USB

The USB 2.0 FS (full speed, 12 Mbit/s) interface can be used for host communication. Due to the hardware implementation, it may not be possible to certify the USB interface. The V\_USB pin supplies the USB interface.

## 5.5 Default interface settings

Interface	Settings
UART1 output	38400 baud, 8 bits, no parity bit, 1 stop bit. NMEA protocol with <b>GGA, GLL, GSA, GSV, RMC, VTG, TXT, ZDA</b> messages are output by default. UBX and RTCM 3.3 protocols are enabled by default but no output messages are enabled by default.
UART1 input	38400 baud, 8 bits, no parity bit, 1 stop bit. UBX, NMEA and RTCM 3.3 input protocols are enabled by default.
UART2 output	38400 baud, 8 bits, no parity bit, 1 stop bit. UBX protocol cannot be enabled. RTCM 3.3 protocol is enabled by default but no output messages are enabled by default. NMEA protocol is disabled by default.
UART2 input	38400 baud, 8 bits, no parity bit, 1 stop bit. UBX protocol cannot be enabled and will not receive UBX input messages. RTCM 3.3 protocol is enabled by default. NMEA protocol is disabled by default.
USB	Default messages activated as in UART1. Input/output protocols available as in UART1.
I2C	Fully compatible with the I2C <sup>15</sup> industry standard, available for communication with an external host CPU or u-blox cellular modules, operated in slave mode only. Default messages activated as in UART1. Input/output protocols available as in UART1. Maximum bit rate 400 kb/s.
SPI	Allow communication to a host CPU, operated in slave mode only. Default messages activated as in UART1. Input/output protocols available as in UART1. SPI is not available unless D_SEL pin is set to low (see section D_SEL interface in Integration manual [1]).

**Table 16: Default interface settings**



Refer to the applicable interface description [2] for information about further settings.



By default the ZED-F9T outputs NMEA messages that include satellite data for all GNSS bands being received. This results in a high NMEA output load for each navigation period. Make sure the UART baud rate used is sufficient for the selected navigation rate and the number of GNSS signals being received.

<sup>15</sup> I2C is a registered trademark of Philips/NXP

## 6 Mechanical specification

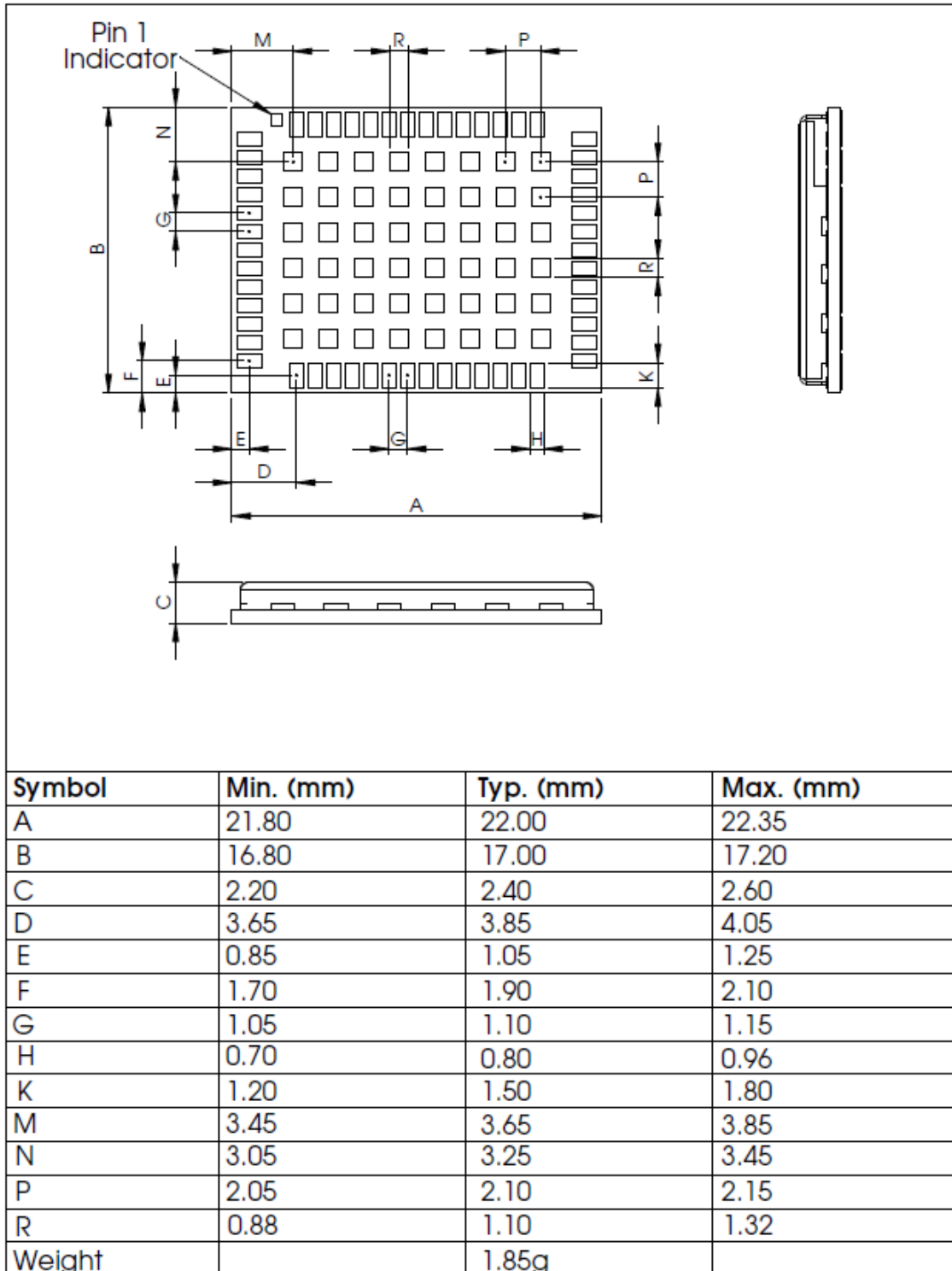

Figure 5: ZED-F9T mechanical drawing

## 7 Reliability tests and approvals

ZED-F9T modules are based on AEC-Q100 qualified GNSS chips.

Tests for product family qualifications are according to ISO 16750 "Road vehicles – environmental conditions and testing for electrical and electronic equipment", and appropriate standards.

### 7.1 Approvals



The ZED-F9T is designed to in compliance with the essential requirements and other relevant provisions of Radio Equipment Directive (RED) 2014/53/EU.

The ZED-F9T complies with the Directive 2011/65/EU (EU RoHS 2) and its amendment Directive (EU) 2015/863 (EU RoHS 3).

Declaration of Conformity (DoC) is available on the [u-blox website](#).

## 8 Labeling and ordering information

This section provides information about product labeling and ordering. For information about moisture sensitivity level (MSL), product handling and soldering see the integration manual [1].

### 8.1 Product labeling

The labeling of the ZED-F9T modules provides product information and revision information. For more information contact u-blox sales.

### 8.2 Explanation of product codes

Three product code formats are used. The **Product name** is used in documentation such as this data sheet and identifies all u-blox products, independent of packaging and quality grade. The **Ordering code** includes options and quality, while the **Type number** includes the hardware and firmware versions.

Table 17 below details these three formats.

Format	Structure	Product code
Product name	PPP-TGV	ZED-F9T
Ordering code	PPP-TGV-NNQ	ZED-F9T-10B
Type number	PPP-TGV-NNQ-XX	ZED-F9T-10B-01

**Table 17: Product code formats**

The parts of the product code are explained in Table 18.

Code	Meaning	Example
PPP	Product family	ZED
TG	Platform	F9 = u-blox F9
V	Variant	T = Timing
NNQ	Option / Quality grade	NN: Option [00...99] Q: Grade, A = Automotive, B = Professional
XX	Product detail	Describes hardware and firmware versions

**Table 18: Part identification code**

### 8.3 Ordering codes

Ordering code	Product	Remark
ZED-F9T-10B	u-blox ZED-F9T	

**Table 19: Product ordering codes**



Product changes affecting form, fit or function are documented by u-blox. For a list of Product Change Notifications (PCNs) see our website at: <https://www.u-blox.com/en/product-resources>.

## Related documents

- [1] ZED-F9T Integration manual, [UBX-21040375](#)
- [2] TIM 2.20 Interface description [UBX-21048598](#)
- [3] Radio Resource LCS Protocol (RRLP), (3GPP TS 44.031 version 11.0.0 Release 11)



For regular updates to u-blox documentation and to receive product change notifications please register on our homepage <https://www.u-blox.com>.

## Revision history

Revision	Date	Name	Status / comments
R01	08-Aug-2020	byou/dama	Objective specification
R02	15-Dec-2020	byou	Objective specification Minor text/typo fixes, Alt. limit change to 80km, QZSS sec. updated,USB certification info. added. NMEA ZDA mess. added to default list,AU office No. update.
R03	16-Apr-2021	byou	Advance Information FW ver. TIM2.11
R04	15-Jun-2021	rzuo	Advance Information FW ver. TIM2.13
R05	28-Jun-2021	byou	Early production information
R06	07-Jan-2022	byou	Early production information FW version TIM2.20; section 1.2: navigation rates updated; section 1.3: NavIC L5 signal enabled; section 4.1: Abs. max. ratings updated; Related docs updated.

# Contact

For complete contact information visit us at [www.u-blox.com](http://www.u-blox.com).

## u-blox Offices

### North, Central and South America

#### u-blox America, Inc.

Phone: +1 703 483 3180  
E-mail: [info\\_us@u-blox.com](mailto:info_us@u-blox.com)

#### Regional Office West Coast

Phone: +1 408 573 3640  
E-mail: [info\\_us@u-blox.com](mailto:info_us@u-blox.com)

#### Technical Support

Phone: +1 703 483 3185  
E-mail: [support\\_us@u-blox.com](mailto:support_us@u-blox.com)

### Headquarters

#### Europe, Middle East, Africa

#### u-blox AG

Phone: +41 44 722 74 44  
E-mail: [info@u-blox.com](mailto:info@u-blox.com)  
Support: [support@u-blox.com](mailto:support@u-blox.com)

### Asia, Australia, Pacific

#### u-blox Singapore Pte. Ltd.

Phone: +65 6734 3811  
E-mail: [info\\_ap@u-blox.com](mailto:info_ap@u-blox.com)  
Support: [support\\_ap@u-blox.com](mailto:support_ap@u-blox.com)

#### Regional Office Australia

Phone: +61 3 9566 7255  
E-mail: [info\\_anz@u-blox.com](mailto:info_anz@u-blox.com)  
Support: [support\\_ap@u-blox.com](mailto:support_ap@u-blox.com)

#### Regional Office China (Beijing)

Phone: +86 10 68 133 545  
E-mail: [info\\_cn@u-blox.com](mailto:info_cn@u-blox.com)  
Support: [support\\_cn@u-blox.com](mailto:support_cn@u-blox.com)

#### Regional Office China (Chongqing)

Phone: +86 23 6815 1588  
E-mail: [info\\_cn@u-blox.com](mailto:info_cn@u-blox.com)  
Support: [support\\_cn@u-blox.com](mailto:support_cn@u-blox.com)

#### Regional Office China (Shanghai)

Phone: +86 21 6090 4832  
E-mail: [info\\_cn@u-blox.com](mailto:info_cn@u-blox.com)  
Support: [support\\_cn@u-blox.com](mailto:support_cn@u-blox.com)

#### Regional Office China (Shenzhen)

Phone: +86 755 8627 1083  
E-mail: [info\\_cn@u-blox.com](mailto:info_cn@u-blox.com)  
Support: [support\\_cn@u-blox.com](mailto:support_cn@u-blox.com)

#### Regional Office India

Phone: +91 80 4050 9200  
E-mail: [info\\_in@u-blox.com](mailto:info_in@u-blox.com)  
Support: [support\\_in@u-blox.com](mailto:support_in@u-blox.com)

#### Regional Office Japan (Osaka)

Phone: +81 6 6941 3660  
E-mail: [info\\_jp@u-blox.com](mailto:info_jp@u-blox.com)  
Support: [support\\_jp@u-blox.com](mailto:support_jp@u-blox.com)

#### Regional Office Japan (Tokyo)

Phone: +81 3 5775 3850  
E-mail: [info\\_jp@u-blox.com](mailto:info_jp@u-blox.com)  
Support: [support\\_jp@u-blox.com](mailto:support_jp@u-blox.com)

#### Regional Office Korea

Phone: +82 2 542 0861  
E-mail: [info\\_kr@u-blox.com](mailto:info_kr@u-blox.com)  
Support: [support\\_kr@u-blox.com](mailto:support_kr@u-blox.com)

#### Regional Office Taiwan

Phone: +886 2 2657 1090  
E-mail: [info\\_tw@u-blox.com](mailto:info_tw@u-blox.com)  
Support: [support\\_tw@u-blox.com](mailto:support_tw@u-blox.com)