

IGBT - Field Stop, Trench 650 V, 50 A

Product Preview FGHL50T65SQDT

Using novel field stop IGBT technology, ON Semiconductor's new series of field stop 4th generation IGBTs offer the optimum performance for solar inverter, UPS, welder, telecom, ESS and PFC applications where low conduction and switching losses are essential.

Features

- Maximum Junction Temperature : $T_J = 175^\circ\text{C}$
- Positive Temperature Co-efficient for Easy Parallel Operating
- High Current Capability
- Low Saturation Voltage: $V_{CE(Sat)} = 1.47\text{ V (Typ.) @ } I_C = 50\text{ A}$
- 100% of the Parts tested for $I_{LM}(1)$
- High Input Impedance
- Fast Switching
- Tighten Parameter Distribution
- This Device is Pb-Free and is RoHS Compliant

Typical Applications

- Solar Inverter, UPS, Welder, Telecom, ESS, PFC

Table 1. MAXIMUM RATING

Symbol	Rating	Value	Unit
V_{CES}	Collector to Emitter Voltage	650	V
V_{GES}	Gate to Emitter Voltage Transient Gate to Emitter Voltage	± 20 ± 30	V
I_C	Collector Current @ $T_C = 25^\circ\text{C}$ @ $T_C = 100^\circ\text{C}$	100 50	A
I_{LM}	Pulsed Collector Current (Note 1)	200	A
I_{CM}	Pulsed Collector Current (Note 2)	200	A
I_F	Diode Forward Current @ $T_C = 25^\circ\text{C}$ @ $T_C = 100^\circ\text{C}$	75 50	A
I_{FM}	Pulsed Diode Maximum Forward Current	300	A
P_D	Maximum Power Dissipation @ $T_C = 25^\circ\text{C}$ @ $T_C = 100^\circ\text{C}$	268 134	W
T_J, T_{STG}	Operating Junction / Storage Temperature Range	-55 to +175	$^\circ\text{C}$
T_L	Maximum Lead Temp. for Soldering Purposes, 1/8" from case for 5 seconds	265	$^\circ\text{C}$

Stresses exceeding those listed in the Maximum Ratings table may damage the device. If any of these limits are exceeded, device functionality should not be assumed, damage may occur and reliability may be affected.

1. $V_{CC} = 400\text{ V}$, $V_{GE} = 15\text{ V}$, $I_C = 200\text{ A}$, $R_G = 3\ \Omega$, Inductive Load, 100% Tested
2. Repetitive rating; pulse width limited by max. Junction temperature

This document contains information on a product under development. ON Semiconductor reserves the right to change or discontinue this product without notice.



ON Semiconductor®

www.onsemi.com

50 A, 650 V
 $V_{CE(Sat)} = 1.47\text{ V (Typ.)}$

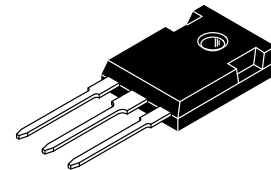
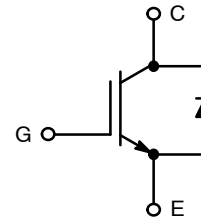

TO-247-3LD
CASE 340CX

MARKING DIAGRAM



FGHL50T65SQDT = Specific Device Code
A = Assembly Location
Y = Year
WW = Work Week
ZZ = Assembly Lot Number

ORDERING INFORMATION

Device	Package	Shipping
FGHL50T65SQDT	TO-247-3L	30 Units / Rail

FGHL50T65SQDT

THERMAL CHARACTERISTICS

Symbol	Rating	Value	Unit
$R_{\theta JC}$	Thermal Resistance, Junction to Case, for IGBT	0.56	$^{\circ}\text{C}/\text{W}$
$R_{\theta JC}$	Thermal Resistance, Junction to Case, Max for Diode	0.65	$^{\circ}\text{C}/\text{W}$
$R_{\theta JA}$	Thermal Resistance, Junction to Ambient, Max	40	$^{\circ}\text{C}/\text{W}$

ELECTRICAL CHARACTERISTICS ($T_J = 25^{\circ}\text{C}$ unless otherwise noted)

Symbol	Parameter	Test Condition	Min	Typ	Max	Unit
--------	-----------	----------------	-----	-----	-----	------

OFF CHARACTERISTICS

V_{CES}	Collector-emitter breakdown voltage, gate-emitter short-circuited	$V_{GE} = 0\text{ V}, I_C = 1\text{ mA}$	650	-	-	V
$\frac{\Delta V_{CES}}{\Delta T_j}$	Temperature Coefficient of Breakdown Voltage	$V_{GE} = 0\text{ V}, I_C = 1\text{ mA}$	-	0.6	-	$\text{V}/^{\circ}\text{C}$
I_{CES}	Collector-emitter cut-off current, gate-emitter short-circuited	$V_{GE} = 0\text{ V}, V_{CE} = V_{CES}$	-	-	250	μA
I_{GES}	Gate leakage current, collector-emitter short-circuited	$V_{GE} = V_{GES}, V_{CE} = 0\text{ V}$	-	-	± 400	nA

ON CHARACTERISTICS

$V_{GE(th)}$	Gate-emitter threshold voltage	$V_{GE} = V_{CE}, I_C = 50\text{ mA}$	2.6	4.5	6.4	V
$V_{CE(sat)}$	Collector-emitter saturation voltage	$V_{GE} = 15\text{ V}, I_C = 50\text{ A}$ $V_{GE} = 15\text{ V}, I_C = 50\text{ A}, T_c = 175^{\circ}\text{C}$	-	1.47	2.1	V
			-	1.7	-	

DYNAMIC CHARACTERISTICS

C_{ies}	Input capacitance	$V_{CE} = 30\text{ V}, V_{GE} = 0\text{ V}, f = 1\text{ MHz}$	-	3081	-	μF
C_{oes}	Output capacitance		-	136	-	
C_{res}	Reverse transfer capacitance		-	10.8	-	

SWITCHING CHARACTERISTICS, INDUCTIVE LOAD

$t_{d(on)}$	Turn-on delay time	$T_C = 25^{\circ}\text{C}$ $V_{CC} = 400\text{ V}, I_C = 12.5\text{ A}$ $R_g = 4.7\ \Omega$ $V_{GE} = 15\text{ V}$ Inductive Load	-	22.8	-	ns	
t_r	Rise time		-	5.20	-		
$t_{d(off)}$	Turn-off delay time		-	70	-		
t_f	Fall time		-	27.20	-		
E_{on}	Turn-on switching loss		-	223	-		μJ
E_{off}	Turn-off switching loss		-	91.13	-		
E_{ts}	Total switching loss		-	314.13	-		
$t_{d(on)}$	Turn-on delay time	$T_C = 25^{\circ}\text{C}$ $V_{CC} = 400\text{ V}, I_C = 25\text{ A}$ $R_g = 4.7\ \Omega$ $V_{GE} = 15\text{ V}$ Inductive Load	-	23.60	-	ns	
t_r	Rise time		-	10.40	-		
$t_{d(off)}$	Turn-off delay time		-	66.40	-		
t_f	Fall time		-	10.20	-		
E_{on}	Turn-on switching loss		-	515.60	-		μJ
E_{off}	Turn-off switching loss		-	133	-		
E_{ts}	Total switching loss		-	648.60	-		

FGHL50T65SQDT

ELECTRICAL CHARACTERISTICS ($T_J = 25^\circ\text{C}$ unless otherwise noted) (continued)

Symbol	Parameter	Test Condition	Min	Typ	Max	Unit
SWITCHING CHARACTERISTICS, INDUCTIVE LOAD						
$t_{d(on)}$	Turn-on delay time	$T_C = 175^\circ\text{C}$ $V_{CC} = 400\text{ V}$, $I_C = 12.5\text{ A}$ $R_g = 4.7\ \Omega$ $V_{GE} = 15\text{ V}$ Inductive Load	-	23.60	-	ns
t_r	Rise time		-	7.20	-	
$t_{d(off)}$	Turn-off delay time		-	87	-	
t_f	Fall time		-	72	-	
E_{on}	Turn-on switching loss		-	259.20	-	μJ
E_{off}	Turn-off switching loss		-	221	-	
E_{ts}	Total switching loss		-	480.20	-	
$t_{d(on)}$	Turn-on delay time	$T_C = 175^\circ\text{C}$ $V_{CC} = 400\text{ V}$, $I_C = 25\text{ A}$ $R_g = 4.7\ \Omega$ $V_{GE} = 15\text{ V}$ Inductive Load	-	25.60	-	ns
t_r	Rise time		-	14.80	-	
$t_{d(off)}$	Turn-off delay time		-	78	-	
t_f	Fall time		-	42	-	
E_{on}	Turn-on switching loss		-	578.90	-	μJ
E_{off}	Turn-off switching loss		-	406.80	-	
E_{ts}	Total switching loss		-	985.70	-	
Qg	Total Gate Charge	$V_{CE} = 400\text{ V}$, $I_C = 50\text{ A}$, $V_{GE} = 15\text{ V}$	-	99.7	-	nC
Qge	Gate to Emitter Charge		-	18.3	-	nC
Qgc	Gate to collector Charge		-	25.90	-	nC

DIODE CHARACTERISTICS

V_F	Forward voltage	$I_F = 50\text{ A}$, $T_C = 25^\circ\text{C}$ $I_F = 50\text{ A}$, $T_C = 175^\circ\text{C}$	- -	2 1.6	2.6 -	V
Erec	Reverse Recovery Energy	$I_F = 50\text{ A}$, $di_F/dt = 200\text{ A}/\mu\text{s}$, $T_C = 175^\circ\text{C}$	-	80.14	-	μJ
Trr	Diode Reverse Recovery Time	$I_F = 50\text{ A}$, $di_F/dt = 200\text{ A}/\mu\text{s}$ $I_F = 50\text{ A}$, $di_F/dt = 200\text{ A}/\mu\text{s}$, $T_C = 175^\circ\text{C}$	-	35.60 201	-	nS
Qrr	Diode Reverse Recovery Charge	$I_F = 50\text{ A}$, $di_F/dt = 200\text{ A}/\mu\text{s}$ $I_F = 50\text{ A}$, $di_F/dt = 200\text{ A}/\mu\text{s}$, $T_C = 175^\circ\text{C}$	-	66.22 1135.65	-	nC

Product parametric performance is indicated in the Electrical Characteristics for the listed test conditions, unless otherwise noted. Product performance may not be indicated by the Electrical Characteristics if operated under different conditions.

FGHL50T65SQDT

TYPICAL CHARACTERISTICS

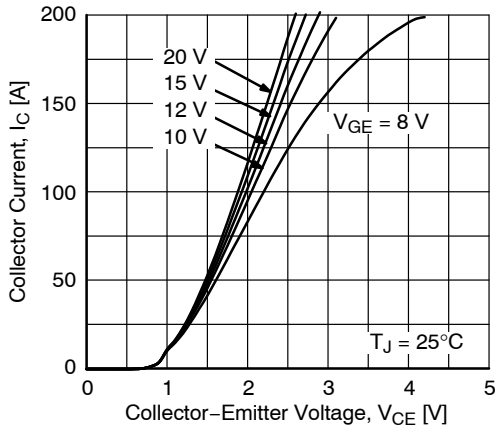

Figure 1. Typical Output Characteristics
($T_J = 25^\circ\text{C}$)

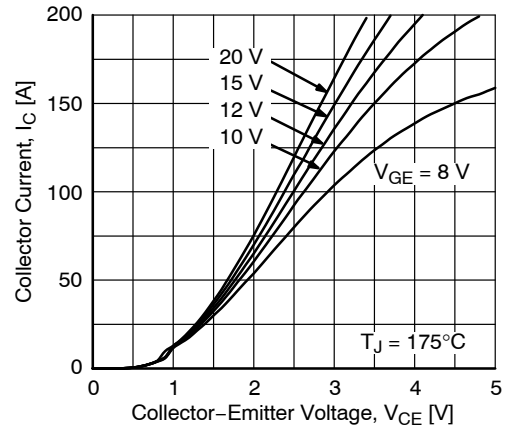

Figure 2. Typical Output Characteristics
($T_J = 175^\circ\text{C}$)

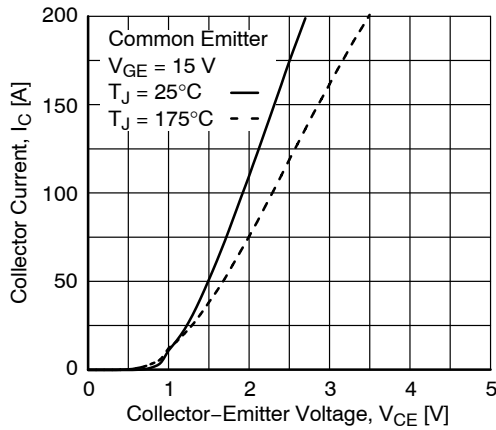

Figure 3. Typical Saturation Voltage Characteristics

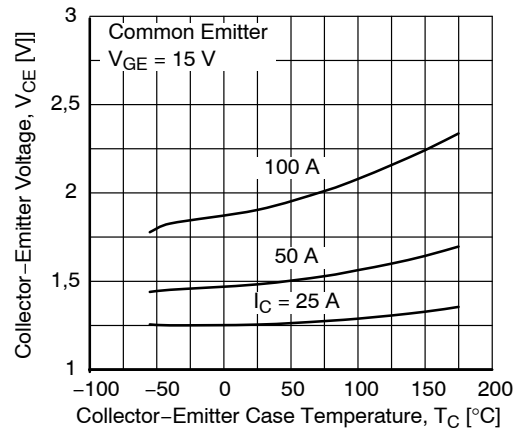

Figure 4. Saturation Voltage vs. Case Temperature at Variant Current Level

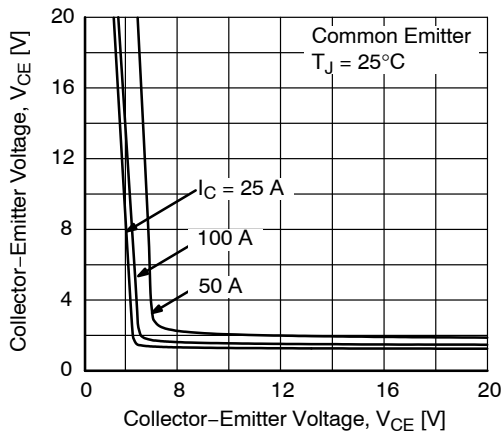

Figure 5. Saturation Voltage vs. V_{GE}
($T_J = 25^\circ\text{C}$)

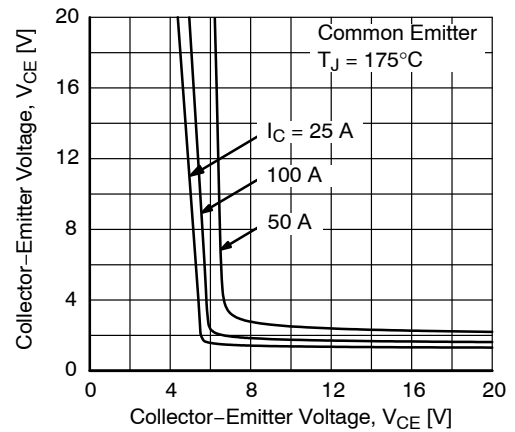

Figure 6. Saturation Voltage vs. V_{GE}
($T_J = 175^\circ\text{C}$)

FGHL50T65SQDT

TYPICAL CHARACTERISTICS (continued)

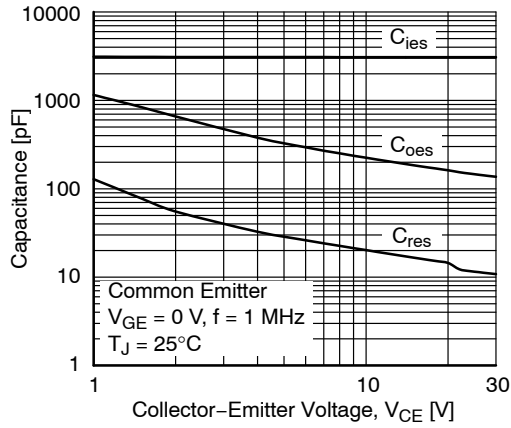

Figure 7. Capacitance Characteristics

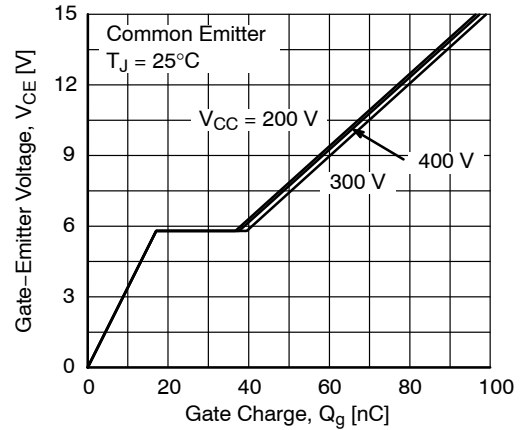

Figure 8. Gate Charge Characteristic

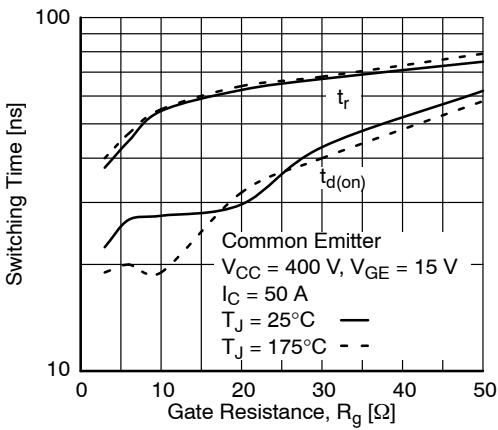

Figure 9. Turn-on Characteristics vs. Gate Resistance

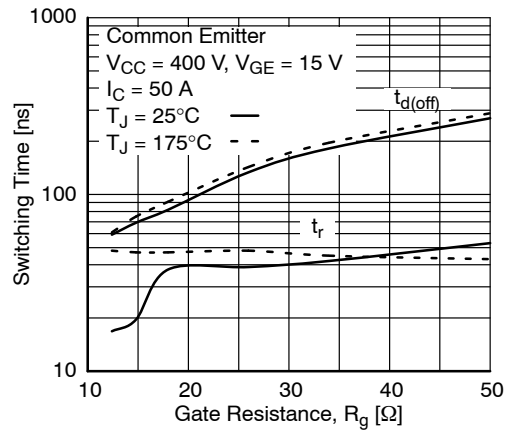

Figure 10. Turn-off Characteristics vs. Gate Resistance

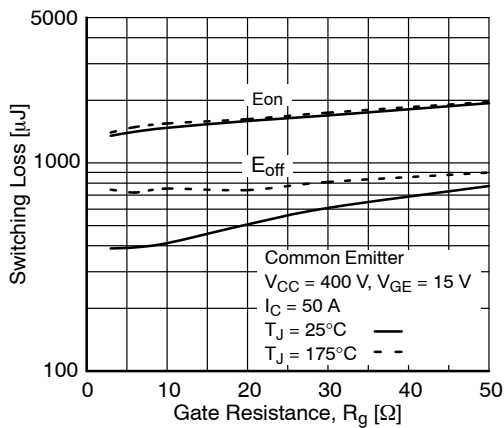

Figure 11. Switching Loss vs Gate Resistance

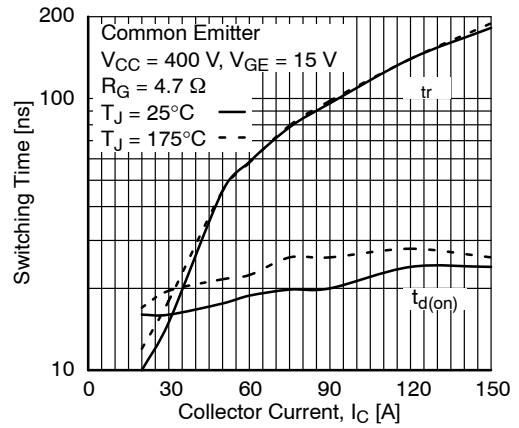

Figure 12. Turn-on Characteristics vs. Collector Current

FGHL50T65SQDT

TYPICAL CHARACTERISTICS (continued)

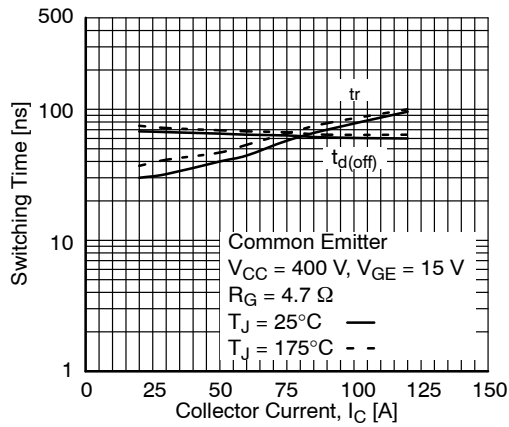

Figure 13. Turn-Off Characteristics vs. Collector Current

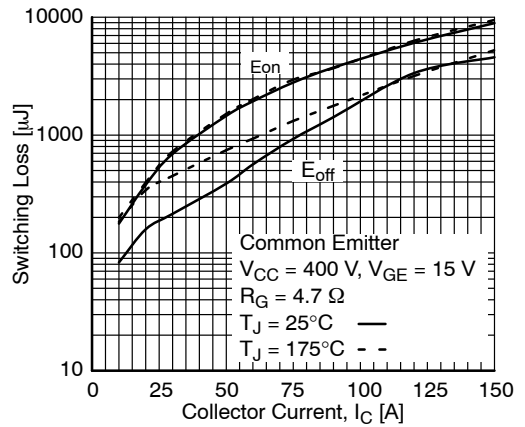

Figure 14. Switching Loss vs. Collector Current

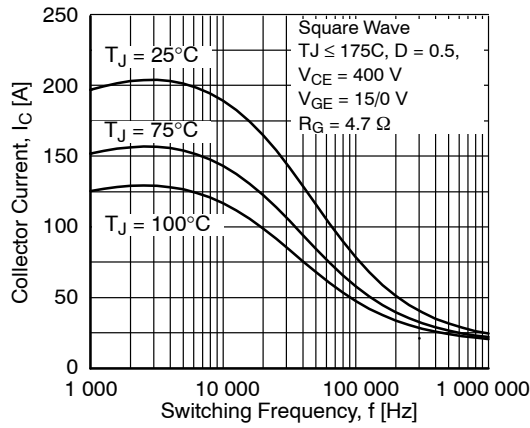

Figure 15. Load Current vs. Frequency

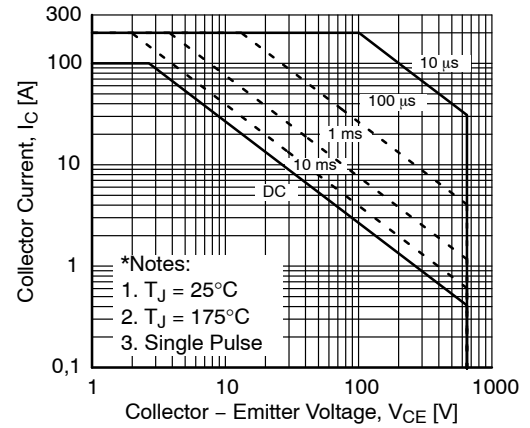

Figure 16. SOA Characteristics (FBSOA)

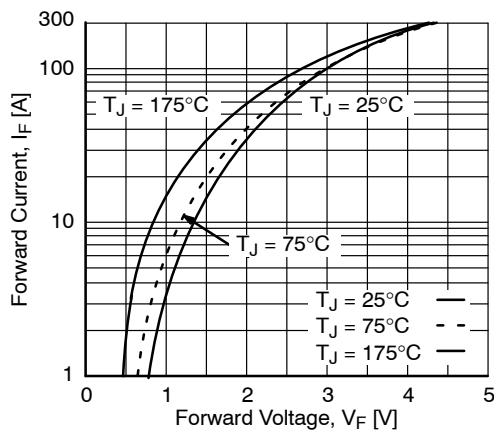

Figure 17. Forward Characteristics

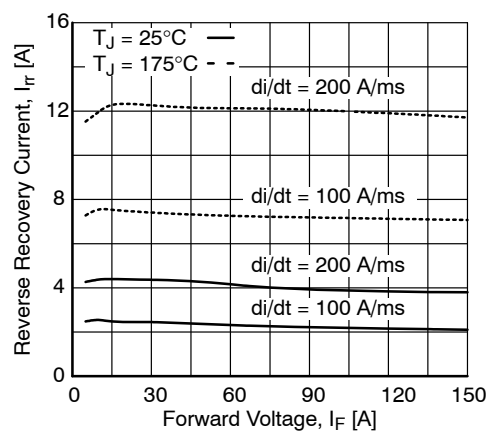

Figure 18. Reverse Recover Current

FGHL50T65SQDT

TYPICAL CHARACTERISTICS (continued)

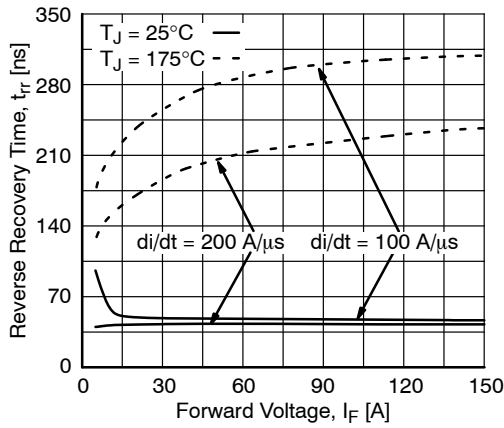

Figure 19. Reverse Recovery Time

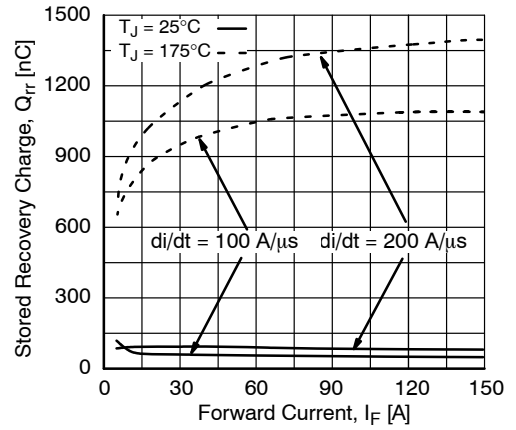

Figure 20. Stored Charge

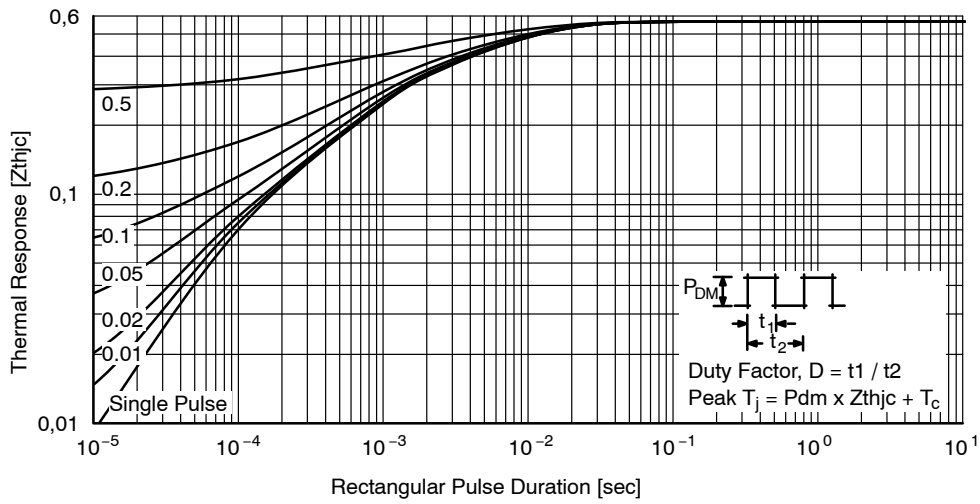

Figure 21. Transient Thermal Impedance of IGBT

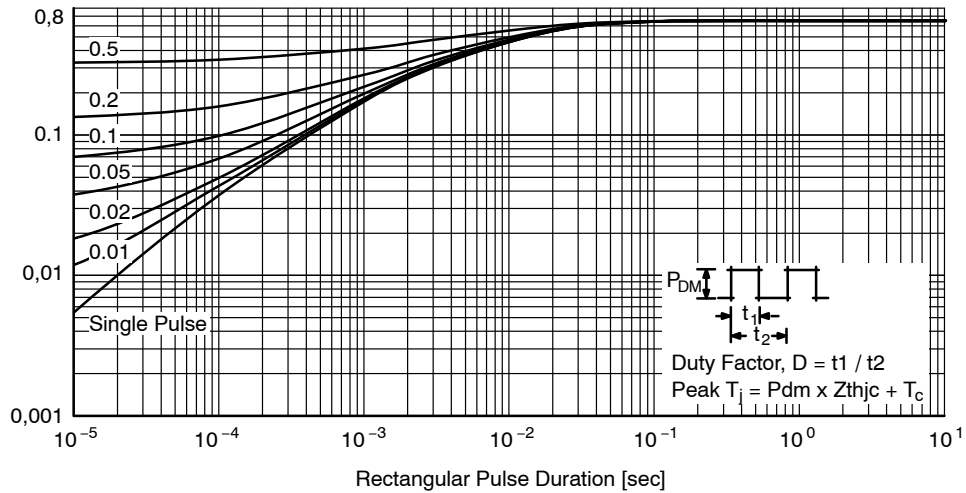

Figure 22. Transient Thermal Impedance of Diode

MECHANICAL CASE OUTLINE

PACKAGE DIMENSIONS

ON Semiconductor®



TO-247-3LD
CASE 340CX
ISSUE A

DATE 06 JUL 2020



NOTES: UNLESS OTHERWISE SPECIFIED.

- A. DIMENSIONS ARE EXCLUSIVE OF BURRS, MOLD FLASH, AND TIE BAR EXTRUSIONS.
- B. ALL DIMENSIONS ARE IN MILLIMETERS.
- C. DRAWING CONFORMS TO ASME Y14.5 - 2009.
- D. DIMENSION A1 TO BE MEASURED IN THE REGION DEFINED BY L1.
- E. LEAD FINISH IS UNCONTROLLED IN THE REGION DEFINED BY L1.

DIM	MILLIMETERS		
	MIN	NOM	MAX
A	4.58	4.70	4.82
A1	2.20	2.40	2.60
A2	1.40	1.50	1.60
D	20.32	20.57	20.82
E	15.37	15.62	15.87
E2	4.96	5.08	5.20
e	~	5.56	~
L	19.75	20.00	20.25
L1	3.69	3.81	3.93
ØP	3.51	3.58	3.65
Q	5.34	5.46	5.58
S	5.34	5.46	5.58
b	1.17	1.26	1.35
b2	1.53	1.65	1.77
b4	2.42	2.54	2.66
c	0.51	0.61	0.71
D1	13.08	~	~
D2	0.51	0.93	1.35
E1	12.81	~	~
ØP1	6.60	6.80	7.00

GENERIC MARKING DIAGRAM*



- XXXXX = Specific Device Code
- A = Assembly Location
- Y = Year
- WW = Work Week
- G = Pb-Free Package

*This information is generic. Please refer to device data sheet for actual part marking. Pb-Free indicator, "G" or microdot "▪", may or may not be present. Some products may not follow the Generic Marking.

DOCUMENT NUMBER:	98AON93302G	Electronic versions are uncontrolled except when accessed directly from the Document Repository. Printed versions are uncontrolled except when stamped "CONTROLLED COPY" in red.
DESCRIPTION:	TO-247-3LD	PAGE 1 OF 1

ON Semiconductor and are trademarks of Semiconductor Components Industries, LLC dba ON Semiconductor or its subsidiaries in the United States and/or other countries. ON Semiconductor reserves the right to make changes without further notice to any products herein. ON Semiconductor makes no warranty, representation or guarantee regarding the suitability of its products for any particular purpose, nor does ON Semiconductor assume any liability arising out of the application or use of any product or circuit, and specifically disclaims any and all liability, including without limitation special, consequential or incidental damages. ON Semiconductor does not convey any license under its patent rights nor the rights of others.

onsemi, **Onsemi**, and other names, marks, and brands are registered and/or common law trademarks of Semiconductor Components Industries, LLC dba "**onsemi**" or its affiliates and/or subsidiaries in the United States and/or other countries. **onsemi** owns the rights to a number of patents, trademarks, copyrights, trade secrets, and other intellectual property. A listing of **onsemi**'s product/patent coverage may be accessed at www.onsemi.com/site/pdf/Patent-Marking.pdf. **onsemi** reserves the right to make changes at any time to any products or information herein, without notice. The information herein is provided "as-is" and **onsemi** makes no warranty, representation or guarantee regarding the accuracy of the information, product features, availability, functionality, or suitability of its products for any particular purpose, nor does **onsemi** assume any liability arising out of the application or use of any product or circuit, and specifically disclaims any and all liability, including without limitation special, consequential or incidental damages. Buyer is responsible for its products and applications using **onsemi** products, including compliance with all laws, regulations and safety requirements or standards, regardless of any support or applications information provided by **onsemi**. "Typical" parameters which may be provided in **onsemi** data sheets and/or specifications can and do vary in different applications and actual performance may vary over time. All operating parameters, including "Typicals" must be validated for each customer application by customer's technical experts. **onsemi** does not convey any license under any of its intellectual property rights nor the rights of others. **onsemi** products are not designed, intended, or authorized for use as a critical component in life support systems or any FDA Class 3 medical devices or medical devices with a same or similar classification in a foreign jurisdiction or any devices intended for implantation in the human body. Should Buyer purchase or use **onsemi** products for any such unintended or unauthorized application, Buyer shall indemnify and hold **onsemi** and its officers, employees, subsidiaries, affiliates, and distributors harmless against all claims, costs, damages, and expenses, and reasonable attorney fees arising out of, directly or indirectly, any claim of personal injury or death associated with such unintended or unauthorized use, even if such claim alleges that **onsemi** was negligent regarding the design or manufacture of the part. **onsemi** is an Equal Opportunity/Affirmative Action Employer. This literature is subject to all applicable copyright laws and is not for resale in any manner.

PUBLICATION ORDERING INFORMATION

LITERATURE FULFILLMENT:

Email Requests to: orderlit@onsemi.com

onsemi Website: www.onsemi.com

TECHNICAL SUPPORT

North American Technical Support:
Voice Mail: 1 800-282-9855 Toll Free USA/Canada
Phone: 011 421 33 790 2910

Europe, Middle East and Africa Technical Support:

Phone: 00421 33 790 2910

For additional information, please contact your local Sales Representative