

Low Dropout Regulator, Wide Input Voltage, Low Iq, 300 mA

NCP718

The NCP718 is 300 mA LDO Linear Voltage Regulator. It is a very stable and accurate device with ultra-low quiescent current consumption (typ. 4 μ A over the full temperature range) and a wide input voltage range (up to 24 V). The regulator incorporates several protection features such as Thermal Shutdown and Current Limiting.

Features

- Operating Input Voltage Range: 2.5 V to 24 V
- Fixed Voltage Options Available: 1.2 V to 5 V (upon request)
- Adjustable Voltage Option from 1.2 V to 5 V
- Ultra-Low Quiescent Current: typ. 4 μ A over Temperature
- $\pm 2\%$ Accuracy Over Full Load, Line and Temperature Variations
- PSRR: 60 dB at 1 kHz
- Noise: typ. 36 μ V_{RMS} from 100 Hz to 100 kHz
- Stable with Small 1 μ F Ceramic Capacitor
- Soft-start to Reduce Inrush Current and Overshoots
- Thermal Shutdown and Current Limit Protection
- SOA Limiting for High Vin / High Iout – Static / Dynamic
- Active Discharge Option Available (upon request)
- Available in TSOT-23-5 and WDFN6 2x2 mm Packages
- These Devices are Pb-Free, Halogen Free/BFR Free and are RoHS Compliant

Typical Applications

- Wireless Chargers
- Portable Equipment
- Communication Systems

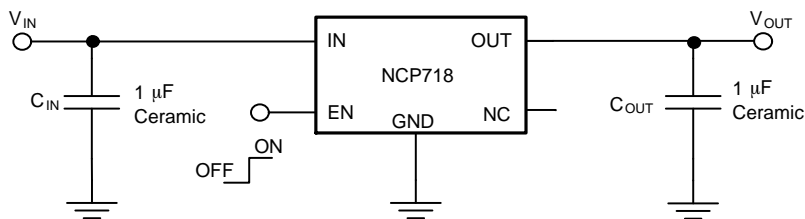

Figure 1. Typical Application Schematic



ON Semiconductor®

www.onsemi.com

MARKING DIAGRAMS

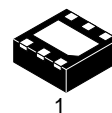

WDFN6
MT SUFFIX
CASE 511BR



XX = Specific Device Code
M = Date Code



TSOT-23-5
SN SUFFIX
CASE 419AE

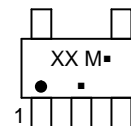

XX = Specific Device Code
M = Date Code*
▪ = Pb-Free Package

(Note: Microdot may be in either location)

*Date Code orientation and/or position may vary depending upon manufacturing location.

PIN CONNECTIONS

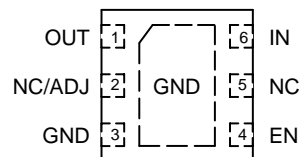

WDFN6 2x2 mm
(Top View)

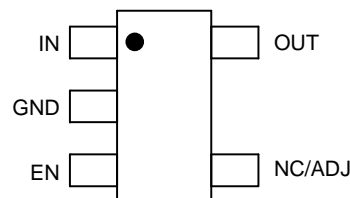

TSOT-23-5
(Top View)

ORDERING INFORMATION

See detailed ordering and shipping information in the package dimensions section on page 7 of this data sheet.

NCP718

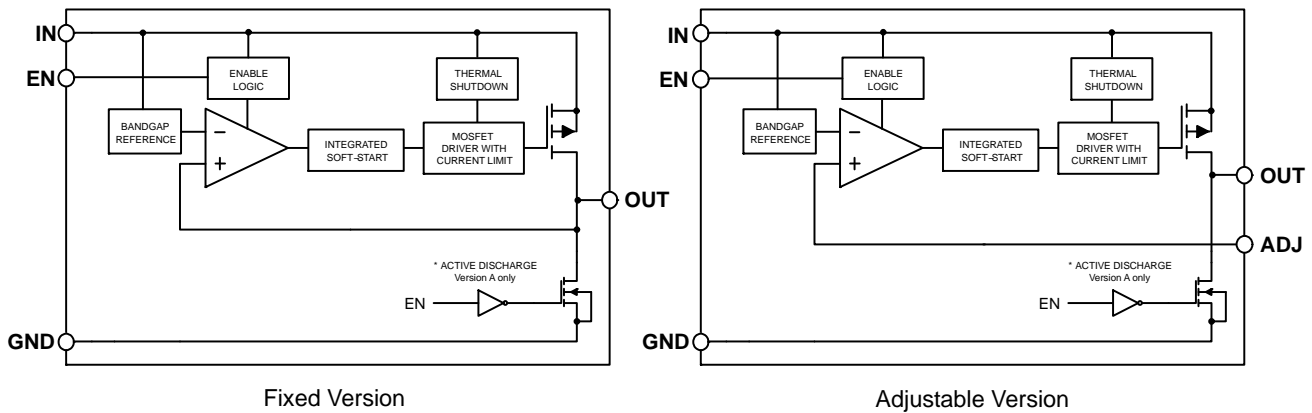

Figure 2. Simplified Block Diagram

Table 1. PIN FUNCTION DESCRIPTION

Pin No. (WDFN6)	Pin No. (TSOT-23-5)	Pin Name	Description
6	1	IN	Input pin. A small capacitor is needed from this pin to ground to assure stability.
3, EXP	2	GND	Power supply ground.
4	3	EN	Enable pin. Driving this pin high turns on the regulator. Driving EN pin low puts the regulator into shutdown mode.
2	4	NC / ADJ	Fixed Version: No connection. This pin can be tied to ground to improve thermal dissipation or left disconnected. Adjustable Version: Feedback pin for set-up output voltage. Use resistor divider for voltage selection.
1	5	OUT	Regulated output voltage pin. A small 1 μ F ceramic capacitor is needed from this pin to ground to assure stability.
5	-	N/C	No connection. This pin can be tied to ground to improve thermal dissipation or left disconnected.

Table 2. ABSOLUTE MAXIMUM RATINGS

Rating	Symbol	Value	Unit
Input Voltage (Note 1)	V_{IN}	-0.3 to 24	V
Enable Voltage	V_{EN}	-0.3 to $V_{IN}+0.3$	V
Output Voltage	V_{OUT}	-0.3 to $V_{IN}+0.3$ (max. 6)	V
Output Short Circuit Duration	t_{SC}	Indefinite	s
Maximum Junction Temperature	$T_{J(MAX)}$	150	$^{\circ}$ C
Storage Temperature	T_{STG}	-55 to 150	$^{\circ}$ C
ESD Capability, Human Body Model (Note 2)	ESD _{HBM}	2000	V
ESD Capability, Charged Device Model (Note 2)	ESD _{CDM}	1000	V

Stresses exceeding those listed in the Maximum Ratings table may damage the device. If any of these limits are exceeded, device functionality should not be assumed, damage may occur and reliability may be affected.

1. Refer to ELECTRICAL CHARACTERISTICS and APPLICATION INFORMATION for Safe Operating Area.
2. This device series incorporates ESD protection and is tested by the following methods:
 ESD Human Body Model tested per AEC-Q100-002 (EIA/JESD22-A114)
 ESD Charged Device Model tested per EIA/JESD22-C101, Field Induced Charge Model.
 Latch up Current Maximum Rating tested per JEDEC standard: JESD78. Latch-up is not guaranteed on ENABLE pin.

Table 3. THERMAL CHARACTERISTICS

Rating	Symbol	Value	Unit
Thermal Characteristics, WDFN6, 2 mm x 2 mm Thermal Resistance, Junction-to-Air	$R_{\theta JA}$	65	$^{\circ}$ C/W
Thermal Characteristics, TSOT-23-5 Thermal Resistance, Junction-to-Air	$R_{\theta JA}$	235	$^{\circ}$ C/W

NCP718

Table 4. ELECTRICAL CHARACTERISTICS $-40^{\circ}\text{C} \leq T_J \leq 125^{\circ}\text{C}$; $V_{IN} = 2.5\text{ V}$ or $(V_{OUT} + 1.0\text{ V})$, whatever is greater; $I_{OUT} = 1\text{ mA}$, $C_{IN} = C_{OUT} = 1\text{ }\mu\text{F}$, unless otherwise noted. Typical values are at $T_J = +25^{\circ}\text{C}$. (Note 3)

Parameter	Test Conditions	Symbol	Min	Typ	Max	Unit
Operating Input Voltage		V_{IN}	2.5		24	V
Output Voltage Accuracy (fixed versions)	$-40^{\circ}\text{C} \leq T_J \leq 125^{\circ}\text{C}$, $V_{OUT} + 1\text{ V} < V_{IN} < 16\text{ V}$, $0.1\text{ mA} < I_{OUT} < 300\text{ mA}$ (Note 5)	$V_{OUT} < 1.8\text{ V}$	-3%		+3%	V
		$V_{OUT} \geq 1.8\text{ V}$	-2%		+2%	
Reference Voltage	$-40^{\circ}\text{C} \leq T_J \leq 125^{\circ}\text{C}$, $V_{OUT} + 1\text{ V} < V_{IN} < 16\text{ V}$	V_{ADJ}		1.2		V
Reference Voltage Accuracy	$-40^{\circ}\text{C} \leq T_J \leq 125^{\circ}\text{C}$, $V_{OUT} + 1\text{ V} < V_{IN} < 16\text{ V}$	V_{OUT}	-2%		+2%	V
Line Regulation	$V_{OUT} + 1\text{ V} \leq V_{IN} \leq 16\text{ V}$, $I_{OUT} = 1\text{ mA}$	Reg _{LINE}		10		mV
Load Regulation	$I_{OUT} = 0.1\text{ mA}$ to 300 mA	Reg _{LOAD}		10		mV
Dropout Voltage (Package TSOT-23-5)	$V_{DO} = V_{IN} - (V_{OUT(NOM)} - 3\%)$, $I_{OUT} = 300\text{ mA}$ (Note 4)	2.1 V – 2.4 V		480		mV
		2.5 V – 2.7 V		320	490	
		2.8 V – 3.2 V		295	465	
		3.3 V – 4.9 V		275	440	
		5 V		250	380	
Dropout Voltage (Package WDFN6)	$V_{DO} = V_{IN} - (V_{OUT(NOM)} - 3\%)$, $I_{OUT} = 300\text{ mA}$ (Note 4)	2.1 V – 2.4 V		490		mV
		2.5 V – 2.7 V		335	505	
		2.8 V – 3.2 V		305	475	
		3.3 V – 4.9 V		285	450	
		5 V		260	395	
Maximum Output Current	$V_{IN} = V_{OUT} + 1\text{ V}$ (Note 5)	I_{LIM}	300		800	mA
Disable Current	$V_{EN} = 0\text{ V}$, $V_{IN} = 5\text{ V}$	I_{DIS}		0.1	1.0	μA
Quiescent Current	$I_{OUT} = 0\text{ mA}$, $-40^{\circ}\text{C} \leq T_J \leq 125^{\circ}\text{C}$	I_Q		4.0	8.0	μA
Ground current	$I_{OUT} = 10\text{ mA}$	I_{GND}		50		μA
	$I_{OUT} = 300\text{ mA}$			300		
Power Supply Rejection Ratio	$V_{IN} = 3.5\text{ V} + 100\text{ mVpp}$ $V_{OUT} = 2.5\text{ V}$ $I_{OUT} = 1\text{ mA}$, $C_{out} = 1\text{ }\mu\text{F}$	$f = 1\text{ kHz}$		60		dB
Output Noise Voltage	$V_{OUT} = 1.2\text{ V}$, $I_{OUT} = 10\text{ mA}$ $f = 100\text{ Hz}$ to 100 kHz	V_N		36		μV_{rms}
Enable Input Threshold Voltage	Voltage increasing	V_{EN_HI}	1.2	–	–	V
	Voltage decreasing	V_{EN_LO}	–	–	0.4	
ADJ Pin Current	$V_{IN} = V_{OUT} + 1\text{ V}$	I_{ADJ}		0.1	1.0	μA
EN Pin Current	$V_{EN} = 5.5\text{ V}$	I_{EN}		100		nA
Active Output Discharge Resistance	$V_{IN} = 5.5\text{ V}$, $V_{EN} = 0\text{ V}$	R_{dis}		100		Ω
Thermal Shutdown Temperature (Note 6)	Temperature increasing from $T_J = +25^{\circ}\text{C}$	T_{SD}		165		$^{\circ}\text{C}$
Thermal Shutdown Hysteresis (Note 6)	Temperature falling from T_{SD}	T_{SDH}	–	25	–	$^{\circ}\text{C}$

Product parametric performance is indicated in the Electrical Characteristics for the listed test conditions, unless otherwise noted. Product performance may not be indicated by the Electrical Characteristics if operated under different conditions.

3. Performance guaranteed over the indicated operating temperature range by design and/or characterization production tested at $T_J = T_A = 25^{\circ}\text{C}$. Low duty cycle pulse techniques are used during testing to maintain the junction temperature as close to ambient as possible.
4. Voltage dropout for voltage variants below 2.1 V is given by minimum input voltage 2.5 V.
5. Respect SOA
6. Guaranteed by design and characterization.

NCP718

TYPICAL CHARACTERISTICS

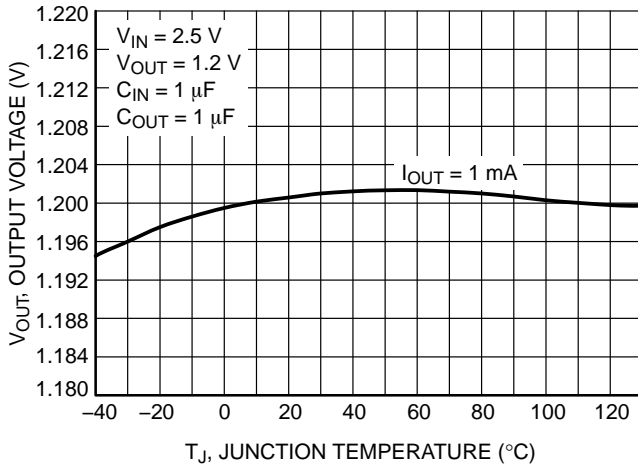

Figure 3. Output Voltage vs. Temperature – $V_{OUT} = 1.2\text{ V}$

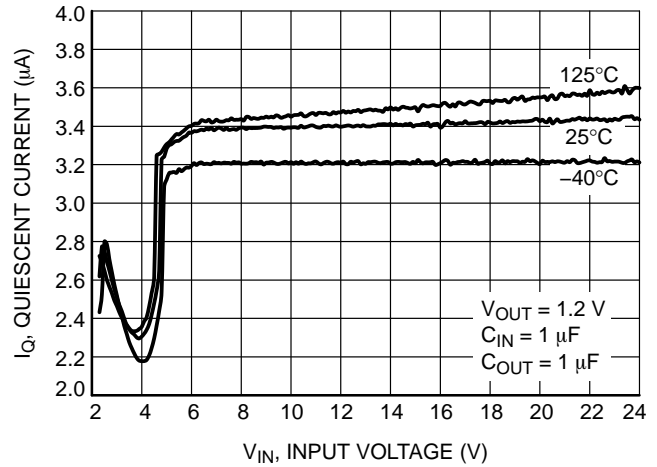

Figure 4. Quiescent Current vs. Input Voltage

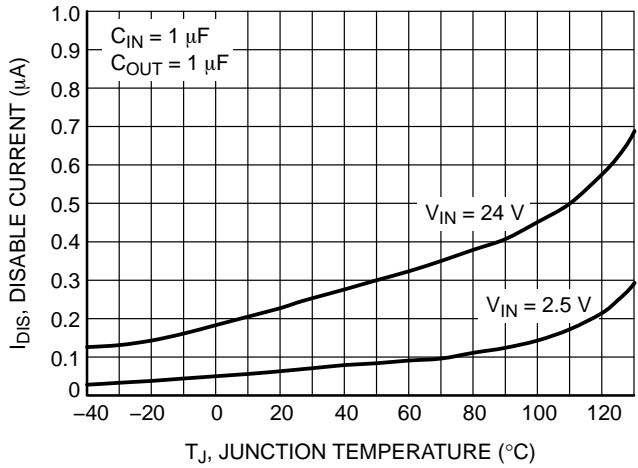

Figure 5. Disable Current vs. Temperature

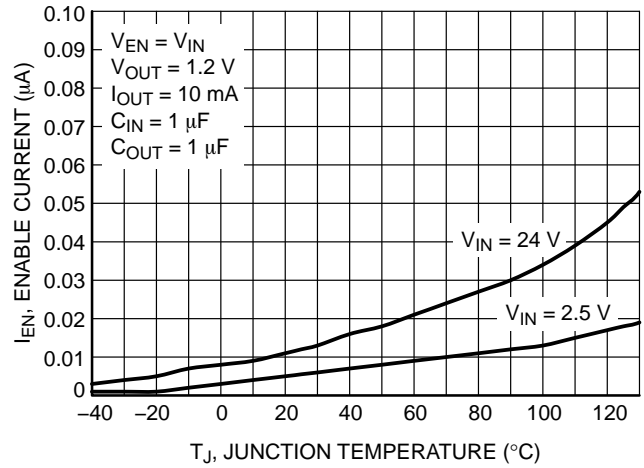

Figure 6. Current to Enable Pin vs. Temperature

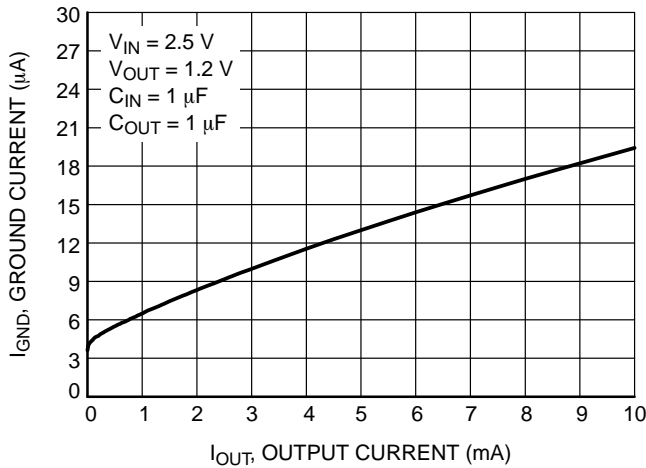

Figure 7. Ground Current vs. Output Current – $V_{OUT} = 1.2\text{ V}$

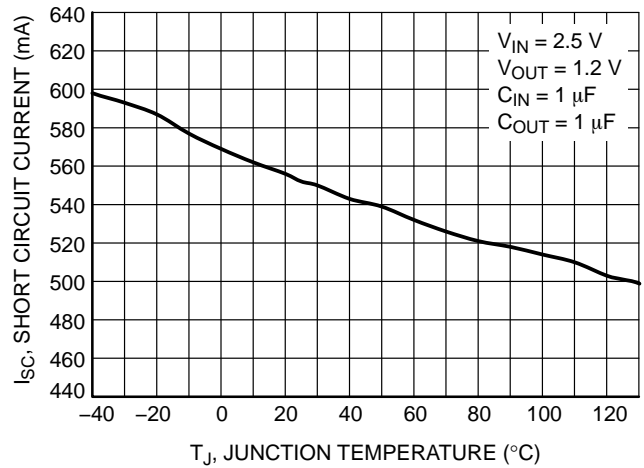

Figure 8. Short Circuit Current vs. Temperature

TYPICAL CHARACTERISTICS

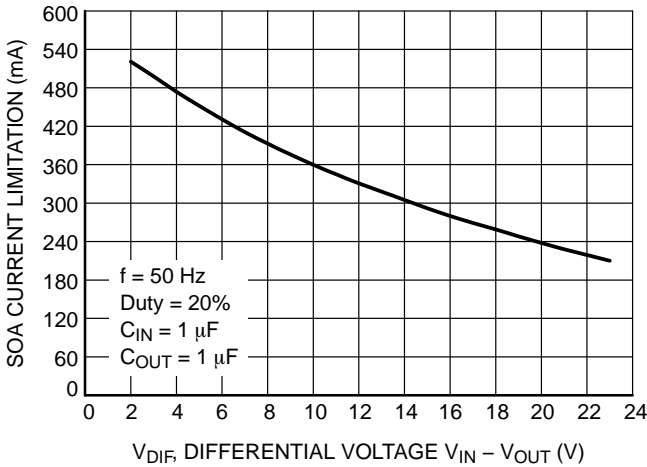

Figure 9. SOA Current Limit vs. Differential Voltage

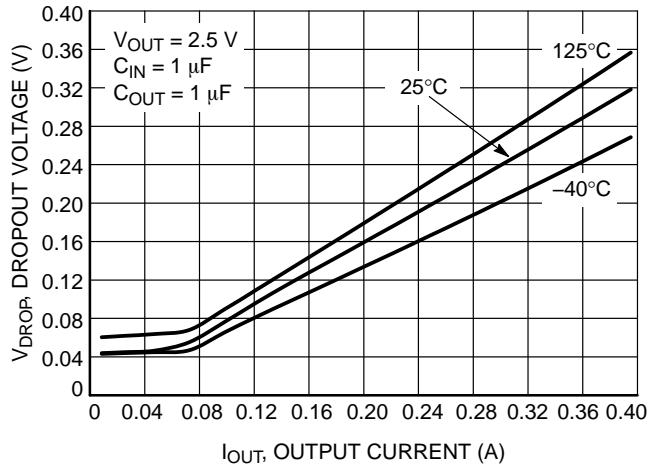

Figure 10. Dropout Voltage vs. Output Current - $V_{OUT} = 2.5 V$

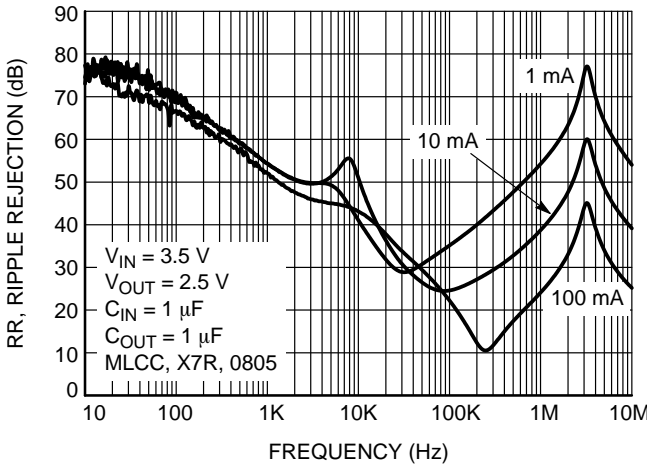

Figure 11. Power Supply Rejection Ratio vs. Current, $V_{IN} = 3.5 V$, $C_{OUT} = 1 \mu F$

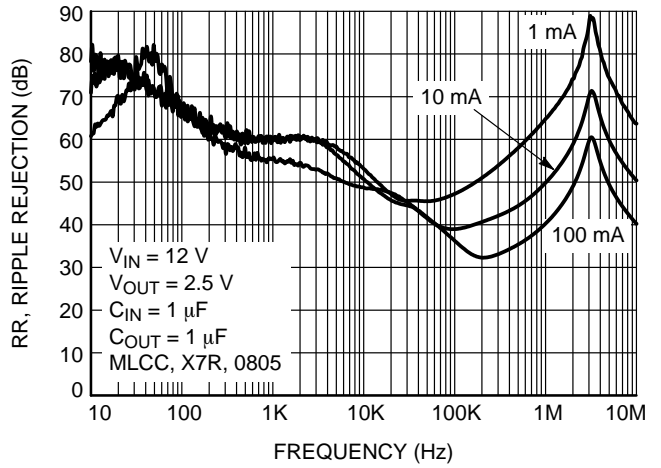

Figure 12. Power Supply Rejection Ratio vs. Current, $V_{IN} = 12 V$, $C_{OUT} = 1 \mu F$

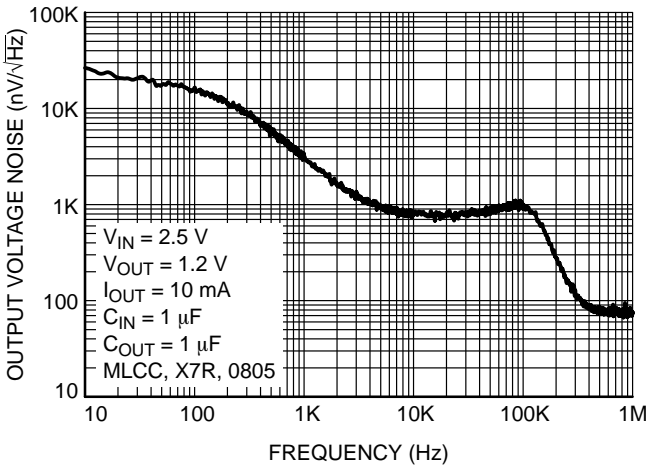

Figure 13. Output Voltage Noise Spectral Density for $V_{OUT} = 1.2 V$, $I_{OUT} = 10 mA$, $C_{OUT} = 1 \mu F$

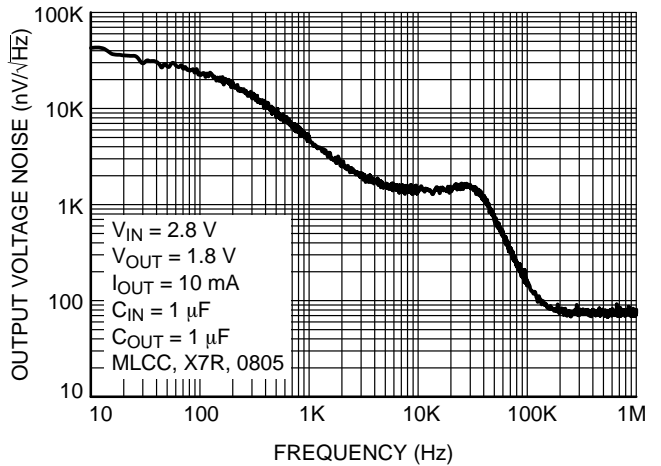

Figure 14. Output Voltage Noise Spectral Density for $V_{OUT} = 1.8 V$, $I_{OUT} = 10 mA$, $C_{OUT} = 1 \mu F$

NCP718

APPLICATIONS INFORMATION

The NCP718 is the member of new family of Wide Input Voltage Range Low Dropout Regulators which delivers Ultra Low Ground Current consumption, Good Noise and Power Supply Rejection Ratio Performance. The NCP718 incorporates EN pin and soft-start feature for simple controlling by microprocessor or logic.

Input Decoupling (C_{IN})

It is recommended to connect at least 1 μF ceramic X5R or X7R capacitor between IN and GND pin of the device. This capacitor will provide a low impedance path for any unwanted AC signals or noise superimposed onto constant input voltage. The good input capacitor will limit the influence of input trace inductances and source resistance during sudden load current changes.

Higher capacitance and lower ESR capacitors will improve the overall line transient response.

Output Decoupling (C_{OUT})

The NCP718 does not require a minimum Equivalent Series Resistance (ESR) for the output capacitor. The device is designed to be stable with standard ceramics capacitors with values of 1 μF or greater. The X5R and X7R types have the lowest capacitance variations over temperature thus they are recommended.

Power Dissipation and Heat Sinking

The maximum power dissipation supported by the device is dependent upon board design and layout. Mounting pad configuration on the PCB, the board material, and the ambient temperature affect the rate of junction temperature rise for the part. For reliable operation junction temperature should be limited to $+125^{\circ}\text{C}$.

The maximum power dissipation the NCP718 can handle is given by:

$$P_{D(\text{MAX})} = \frac{[T_{J(\text{MAX})} - T_A]}{R_{\theta JA}} \quad (\text{eq. 1})$$

The power dissipated by the NCP718 for given application conditions can be calculated from the following equations:

$$P_D \approx V_{IN}(I_{\text{GND}} + I_{\text{OUT}}) + I_{\text{OUT}}(V_{IN} - V_{\text{OUT}}) \quad (\text{eq. 2})$$

or

$$V_{IN(\text{MAX})} \approx \frac{P_{D(\text{MAX})} + (V_{\text{OUT}} \times I_{\text{OUT}})}{I_{\text{OUT}} + I_{\text{GND}}} \quad (\text{eq. 3})$$

Hints

V_{IN} and GND printed circuit board traces should be as wide as possible. When the impedance of these traces is high, there is a chance to pick up noise or cause the regulator to malfunction. Place external components, especially the output capacitor, as close as possible to the NCP718, and make traces as short as possible.

ADJUSTABLE VERSION

The output voltage can be set by using a resistor divider as shown in Figure 15 with a range of 1.2 V to 5 V. The appropriate resistor divider can be found by solving the equation below, while $V_{\text{REF}} = 1.2 \text{ V}$

$$V_{\text{OUT}} = V_{\text{REF}} \cdot \frac{(R1 + R2)}{R1} = V_{\text{REF}} \cdot \left(1 + \frac{R2}{R1}\right) \quad (\text{eq. 4})$$

Value of R1 and R2 is recommended to keep below 100 k Ω for R1 and below 1 M Ω for R2 to avoid influence of current I_{ADJ} variation over temperature range.

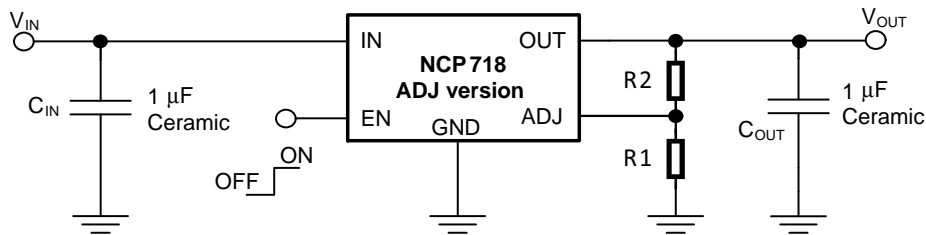

Figure 15. Adjustable Version Connection Schematic

Please note that output noise is amplified by $V_{\text{OUT}}/V_{\text{ADJ}}$ ratio. For simplified calculation, output noise is equal to

$30 \mu\text{V}_{\text{RMS}} * V_{\text{OUT}}$. Do not operate the device at output voltage about 5.2 V, as device can be damaged.

NCP718

ORDERING INFORMATION

Device Part No.	Voltage Option	Marking	Option	Package	Shipping†
NCP718AMTADJTBG	Adj.	GA	With Active Output Discharge	WDFN6 (Pb-Free)	3000 / Tape & Reel
NCP718AMT120TBG	1.2 V	GN			
NCP718AMT180TBG	1.8 V	GP			
NCP718AMT250TBG	2.5 V	GD			
NCP718AMT300TBG	3.0 V	GQ			
NCP718AMT330TBG	3.3 V	GR			
NCP718AMT500TBG	5.0 V	GM			
NCP718BMTADJTBG	Adj.	GC	Without Active Output Discharge		
NCP718BMT180TBG	1.8 V	GU			
NCP718BMT300TBG	3.0 V	GV			
NCP718BMT330TBG	3.3 V	GW			
NCP718BMT500TBG	5.0 V	GE			
NCP718ASNADJT1G	Adj.	GAA	With Active Output Discharge	TSOT-23-5 (Pb-Free)	3000 / Tape & Reel
NCP718ASN120T1G	1.2 V	GAE			
NCP718ASN150T1G	1.5 V	GAF			
NCP718ASN180T1G	1.8 V	GAD			
NCP718ASN250T1G	2.5 V	GAG			
NCP718ASN300T1G	3.0 V	GAH			
NCP718ASN330T1G	3.3 V	GAJ			
NCP718ASN500T1G	5.0 V	GAK			
NCP718BSNADJT1G	Adj.	GAC	Without Active Output Discharge		
NCP718BSN120T1G	1.2 V	GCA			
NCP718BSN150T1G	1.5 V	GCC			
NCP718BSN180T1G	1.8 V	GCD			
NCP718BSN250T1G	2.5 V	GCF			
NCP718BSN300T1G	3.0 V	GCG			
NCP718BSN330T1G	3.3 V	GCH			
NCP718BSN500T1G	5.0 V	GCE			

†For information on tape and reel specifications, including part orientation and tape sizes, please refer to our Tape and Reel Packaging Specifications Brochure, BRD8011/D.

MECHANICAL CASE OUTLINE

PACKAGE DIMENSIONS

ON Semiconductor®



TSOT-23, 5 LEAD
CASE 419AE-01
ISSUE O

DATE 19 DEC 2008

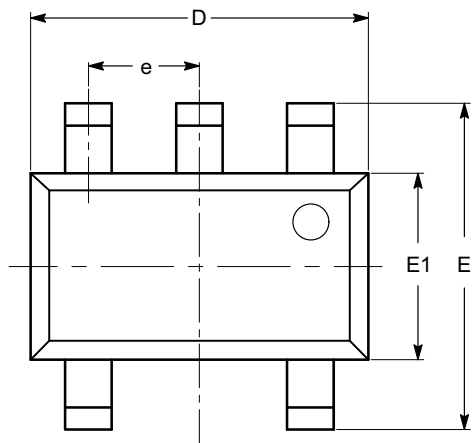

TOP VIEW

SYMBOL	MIN	NOM	MAX
A			1.00
A1	0.01	0.05	0.10
A2	0.80	0.87	0.90
b	0.30		0.45
c	0.12	0.15	0.20
D	2.90 BSC		
E	2.80 BSC		
E1	1.60 BSC		
e	0.95 TYP		
L	0.30	0.40	0.50
L1	0.60 REF		
L2	0.25 BSC		
θ	0°		8°

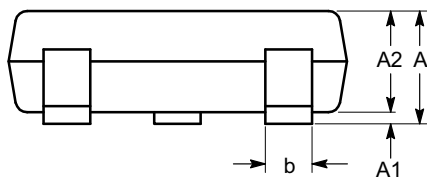

SIDE VIEW

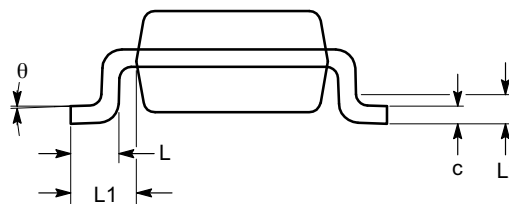

END VIEW

Notes:

- (1) All dimensions are in millimeters. Angles in degrees.
- (2) Complies with JEDEC MO-193.

DOCUMENT NUMBER:	98AON34392E	Electronic versions are uncontrolled except when accessed directly from the Document Repository. Printed versions are uncontrolled except when stamped "CONTROLLED COPY" in red.
DESCRIPTION:	TSOT-23, 5 LEAD	PAGE 1 OF 1

ON Semiconductor and are trademarks of Semiconductor Components Industries, LLC dba ON Semiconductor or its subsidiaries in the United States and/or other countries. ON Semiconductor reserves the right to make changes without further notice to any products herein. ON Semiconductor makes no warranty, representation or guarantee regarding the suitability of its products for any particular purpose, nor does ON Semiconductor assume any liability arising out of the application or use of any product or circuit, and specifically disclaims any and all liability, including without limitation special, consequential or incidental damages. ON Semiconductor does not convey any license under its patent rights nor the rights of others.

MECHANICAL CASE OUTLINE PACKAGE DIMENSIONS

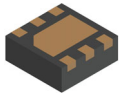

WDFN6 2x2, 0.65P
CASE 511BR
ISSUE C

DATE 01 DEC 2021

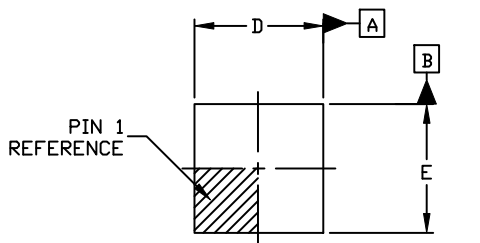

TOP VIEW

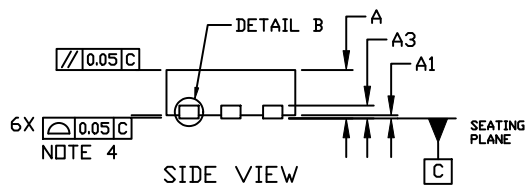

SIDE VIEW

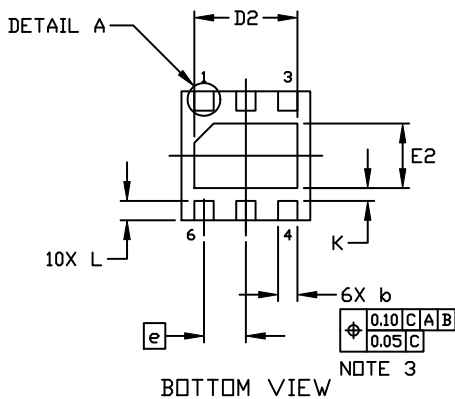

BOTTOM VIEW

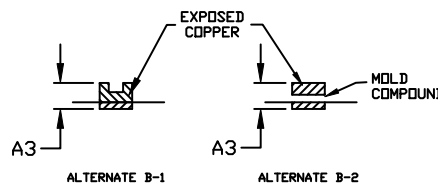

DETAIL B
ALTERNATE CONSTRUCTION

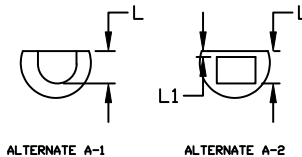

DETAIL A
ALTERNATE CONSTRUCTIONS

DIM	MILLIMETERS		
	MIN.	NDM.	MAX.
A	0.70	0.75	0.80
A1	0.00	---	0.05
A3	0.20 REF		
b	0.25	0.30	0.35
D	1.90	2.00	2.10
D2	1.50	1.60	1.70
E	1.90	2.00	2.10
E2	0.90	1.00	1.10
e	0.65 BSC		
K	0.20 REF		
L	0.20	0.30	0.40
L1	---	---	0.15

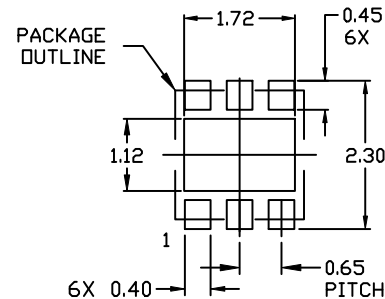

RECOMMENDED
MOUNTING FOOTPRINT

For additional information on our Pb-Free strategy and soldering details, please download the ON Semiconductor Soldering and Mounting Techniques Reference Manual, SOLDERM/D.

GENERIC MARKING DIAGRAM*



XX = Specific Device Code
M = Date Code

This information is generic. Please refer to device data sheet for actual part marking. Pb-Free indicator, "G" or microdot "", may or may not be present. Some products may not follow the Generic Marking.

DOCUMENT NUMBER:	98AON55829E	Electronic versions are uncontrolled except when accessed directly from the Document Repository. Printed versions are uncontrolled except when stamped "CONTROLLED COPY" in red.
DESCRIPTION:	WDFN6 2X2, 0.65P	PAGE 1 OF 1

onsemi and ONSEMI are trademarks of Semiconductor Components Industries, LLC dba onsemi or its subsidiaries in the United States and/or other countries. onsemi reserves the right to make changes without further notice to any products herein. onsemi makes no warranty, representation or guarantee regarding the suitability of its products for any particular purpose, nor does onsemi assume any liability arising out of the application or use of any product or circuit, and specifically disclaims any and all liability, including without limitation special, consequential or incidental damages. onsemi does not convey any license under its patent rights nor the rights of others.

onsemi, **Onsemi**, and other names, marks, and brands are registered and/or common law trademarks of Semiconductor Components Industries, LLC dba "**onsemi**" or its affiliates and/or subsidiaries in the United States and/or other countries. **onsemi** owns the rights to a number of patents, trademarks, copyrights, trade secrets, and other intellectual property. A listing of **onsemi**'s product/patent coverage may be accessed at www.onsemi.com/site/pdf/Patent-Marking.pdf. **onsemi** reserves the right to make changes at any time to any products or information herein, without notice. The information herein is provided "as-is" and **onsemi** makes no warranty, representation or guarantee regarding the accuracy of the information, product features, availability, functionality, or suitability of its products for any particular purpose, nor does **onsemi** assume any liability arising out of the application or use of any product or circuit, and specifically disclaims any and all liability, including without limitation special, consequential or incidental damages. Buyer is responsible for its products and applications using **onsemi** products, including compliance with all laws, regulations and safety requirements or standards, regardless of any support or applications information provided by **onsemi**. "Typical" parameters which may be provided in **onsemi** data sheets and/or specifications can and do vary in different applications and actual performance may vary over time. All operating parameters, including "Typicals" must be validated for each customer application by customer's technical experts. **onsemi** does not convey any license under any of its intellectual property rights nor the rights of others. **onsemi** products are not designed, intended, or authorized for use as a critical component in life support systems or any FDA Class 3 medical devices or medical devices with a same or similar classification in a foreign jurisdiction or any devices intended for implantation in the human body. Should Buyer purchase or use **onsemi** products for any such unintended or unauthorized application, Buyer shall indemnify and hold **onsemi** and its officers, employees, subsidiaries, affiliates, and distributors harmless against all claims, costs, damages, and expenses, and reasonable attorney fees arising out of, directly or indirectly, any claim of personal injury or death associated with such unintended or unauthorized use, even if such claim alleges that **onsemi** was negligent regarding the design or manufacture of the part. **onsemi** is an Equal Opportunity/Affirmative Action Employer. This literature is subject to all applicable copyright laws and is not for resale in any manner.

PUBLICATION ORDERING INFORMATION

LITERATURE FULFILLMENT:

Email Requests to: orderlit@onsemi.com

onsemi Website: www.onsemi.com

TECHNICAL SUPPORT

North American Technical Support:

Voice Mail: 1 800-282-9855 Toll Free USA/Canada

Phone: 011 421 33 790 2910

Europe, Middle East and Africa Technical Support:

Phone: 00421 33 790 2910

For additional information, please contact your local Sales Representative