

# NCV7420

## LIN Transceiver with 3.3 V or 5 V Voltage Regulator

### General Description

The NCV7420 is a fully featured local interconnect network (LIN) transceiver designed to interface between a LIN protocol controller and the physical bus. The transceiver is implemented in I3T technology enabling both high-voltage analog circuitry and digital functionality to co-exist on the same chip.

The NCV7420 LIN device is a member of the in-vehicle networking (IVN) transceiver family of ON Semiconductor that integrates a LIN v2.0/2.1 physical transceiver and either a 3.3 V or a 5 V voltage regulator.

The LIN bus is designed to communicate low rate data from control devices such as door locks, mirrors, car seats, and sunroofs at the lowest possible cost. The bus is designed to eliminate as much wiring as possible and is implemented using a single wire in each node. Each node has a slave MCU-state machine that recognizes and translates the instructions specific to that function. The main attraction of the LIN bus is that all the functions are not time critical and usually relate to passenger comfort.

### KEY FEATURES

#### LIN-Bus Transceiver

- LIN compliant to specification revision 2.0 and 2.1 (backward compatible to version 1.3) and J2602
- I3T high voltage technology
- Bus voltage  $\pm 45$  V
- Transmission rate up to 20 kBaud

#### Protection

- Thermal shutdown
- Indefinite short-circuit protection on pins LIN and WAKE towards supply and ground
- Load dump protection (45 V)
- Bus pins protected against transients in an automotive environment
- System ESD protection level for LIN, WAKE and  $V_{BB}$  up to  $\pm 12$  kV

#### Voltage Regulator

- Output voltage 5 V /  $\sim 50$  mA or 3.3 V /  $\sim 50$  mA
- Wake-up input
- Enable inputs for standby and sleep mode
- INH output for auxiliary purposes (switching of an external pull-up or resistive divider towards battery, control of an external voltage regulator etc.)



ON Semiconductor®

[www.onsemi.com](http://www.onsemi.com)

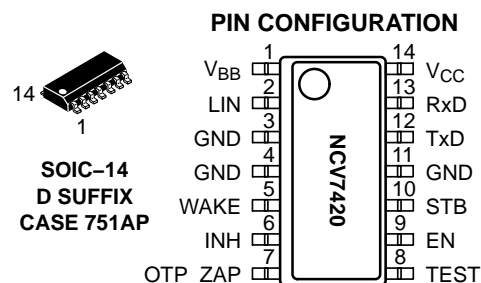

### ORDERING INFORMATION

See detailed ordering and shipping information in the package dimensions section on page 19 of this data sheet.

#### EMI Compatibility

- Integrated slope control
- Meets most demanding EMS/EME requirements

#### Modes

- Normal mode: LIN communication in either low (up to 10 kBaud) or normal slope
- Sleep mode:  $V_{CC}$  is switched “off” and no communication on LIN bus
- Standby mode:  $V_{CC}$  is switched “on” but there is no communication on LIN bus
- Wake-up bringing the component from sleep mode into standby mode is possible either by LIN command or digital input signal on WAKE pin. Wake-up from LIN bus can also be detected and flagged when the chip is already in standby mode.

#### Quality

- NCV Prefix for Automotive and Other Applications Requiring Unique Site and Control Change Requirements; AEC-Q100 Qualified and PPAP Capable
- These Devices are Pb-Free, Halogen Free/BFR Free and are RoHS Compliant

# NCV7420

## MARKING DIAGRAM

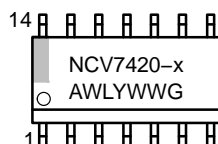

NCV7420 = Specific Device Code  
 -x = -3 = NCV7420D23G  
       -4 = NCV7420D24G  
       -5 = NCV7420D25G  
       -6 = NCV7420D26G  
 A = Assembly Location  
 WL = Wafer Lot  
 Y = Year  
 WW = Work Week  
 G = Pb-Free Package

**Table 1. KEY TECHNICAL CHARACTERISTICS – 3.3 V version**

Symbol	Parameter	Min	Typ	Max	Unit
V <sub>BB</sub>	Nominal battery operating voltage (Note 1)	5	12	26	V
	Load dump protection (Note 2)			45	
I <sub>BB_SLP</sub>	Supply current in sleep mode			20	μA
V <sub>CC_OUT</sub> (Note 4)	Regulated V <sub>CC</sub> output, V <sub>CC</sub> load 1 mA–30 mA	3.23	3.30	3.37	V
	Regulated V <sub>CC</sub> output, V <sub>CC</sub> load 0 mA–50 mA	3.19	3.30	3.41	
I <sub>OUT_MAX</sub>	Maximum V <sub>CC</sub> output current (Note 3)	50			mA
V <sub>WAKE</sub>	Operating DC voltage on WAKE pin	0		V <sub>BB</sub>	V
	Maximum rating voltage on WAKE pin	-45		45	
T <sub>JSD</sub>	Junction thermal shutdown temperature	165		195	°C
T <sub>J</sub>	Operating junction temperature	-40		+150	°C

**Table 2. KEY TECHNICAL CHARACTERISTICS – 5 V version**

Symbol	Parameter	Min	Typ	Max	Unit
V <sub>BB</sub>	Nominal battery operating voltage (Note 1)	6	12	26	V
	Load dump protection			45	
I <sub>BB_SLP</sub>	Supply current in sleep mode			20	μA
V <sub>CC_OUT</sub> (Note 4)	Regulated V <sub>CC</sub> output, V <sub>CC</sub> load 1 mA–30 mA	4.9	5.0	5.1	V
	Regulated V <sub>CC</sub> output, V <sub>CC</sub> load 0 mA–50 mA	4.83	5.0	5.17	
I <sub>OUT_MAX</sub>	Maximum V <sub>CC</sub> output current (Note 3)	50			mA
V <sub>WAKE</sub>	Operating DC voltage on WAKE pin	0		V <sub>BB</sub>	V
	Maximum rating voltage on WAKE pin	-45		45	
T <sub>JSD</sub>	Junction thermal shutdown temperature	165		195	°C
T <sub>J</sub>	Operating junction temperature	-40		+150	°C

- Below 5 V on V<sub>BB</sub> in normal mode, the bus will either stay recessive or comply with the voltage level specifications and transition time specifications as required by SAE J2602. It is ensured by the battery monitoring circuit.
- The applied transients shall be in accordance with ISO 7637 part 1, test pulse 5. The device complies with functional class C; class A can be reached depending on the application and external conditions.
- Thermal aspects of the entire end-application have to be taken into account in order to avoid thermal shutdown of NCV7420.
- V<sub>CC</sub> voltage regulator output must be properly decoupled by external capacitor of min. 8 μF with ESR < 1 Ω to ensure stability.

**Table 3. THERMAL CHARACTERISTICS**

Symbol	Parameter	Conditions	Value	Unit
R <sub>θJA1</sub>	Thermal resistance junction-to-ambient, 1S0P PCB (Note 5)	free air	140	K/W
R <sub>θJA2</sub>	Thermal resistance junction-to-ambient, 2S2P PCB (Note 6)	free air	80	K/W

- Test board according to EIA/JEDEC Standard JESD51-3, signal layer with 20% trace coverage
- Test board according to EIA/JEDEC Standard JESD51-7, signal layers with 20% trace coverage

# NCV7420

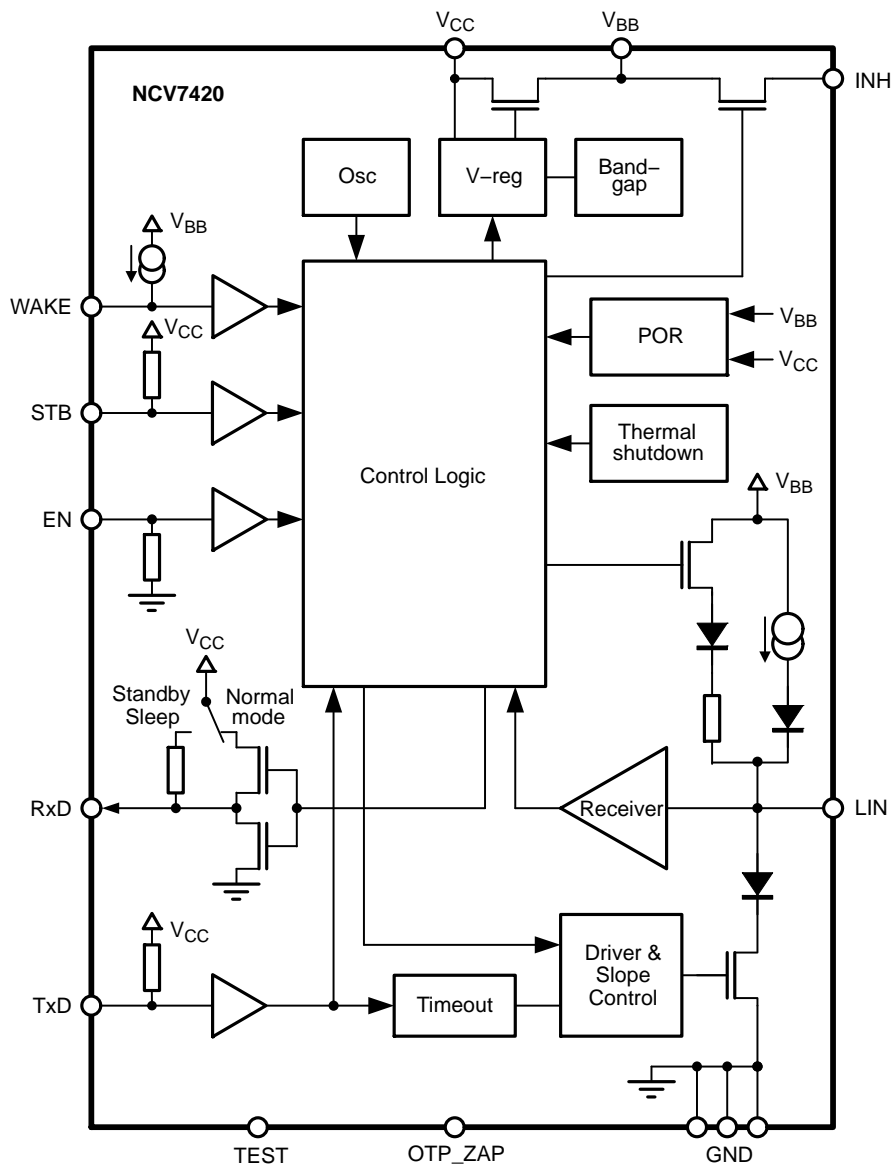

Figure 1. Block Diagram

## Typical Application

### Application Schematic

The EMC immunity of the Master-mode device can be further enhanced by adding a capacitor between the LIN output and ground. The optimum value of this capacitor is

determined by the length and capacitance of the LIN bus, the number and capacitance of Slave devices, the pull-up resistance of all devices (Master & Slave), and the required time constant of the system, respectively.

$V_{CC}$  voltage must be properly stabilized by external capacitor: capacitor of min. 8  $\mu\text{F}$  (ESR < 1  $\Omega$ ).

# NCV7420

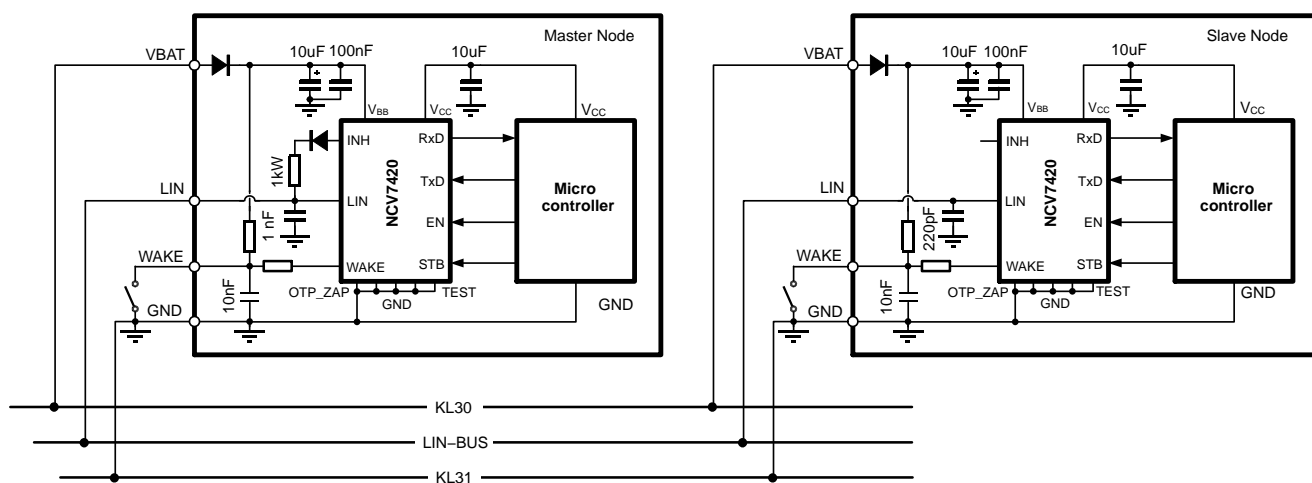

Figure 2. Typical Application Diagram

Table 4. PIN DESCRIPTION

Pin	Name	Description
1	V <sub>BB</sub>	Battery supply input
2	LIN	LIN bus output/input
3	GND	Ground
4	GND	Ground
5	WAKE	High voltage digital input pin to switch the part from sleep- to standby mode
6	INH	Inhibit output
7	OTP_ZAP	Supply for programming of trimming bits at factory testing, should be grounded in the application
8	TEST	Digital input for factory testing, should be grounded in the application
9	EN	Enable input, transceiver in normal operation mode when high
10	STB	Standby mode control input
11	GND	Ground
12	TxD	Transmit data input, low in dominant state
13	RxD	Receive data output; low in dominant state; push-pull output
14	V <sub>CC</sub>	Supply voltage (output)

## Overall Functional Description

LIN is a serial communication protocol that efficiently supports the control of mechatronic nodes in distributed automotive applications. The domain is class-A multiplex buses with a single master node and a set of slave nodes.

NCV7420 is designed as a master or slave node for the LIN communication interface with an integrated 3.3 V or 5 V voltage regulator having a current capability up to 50 mA for supplying any external components (microcontroller).

NCV7420 contains the LIN transmitter, LIN receiver, voltage regulator, power-on-reset (POR) circuits and thermal shutdown (TSD). The LIN transmitter is optimized for the maximum specified transmission speed of 20 kBaud

with EMC performance due to reduced slew rate of the LIN output.

The junction temperature is monitored via a thermal shutdown circuit that switches the LIN transmitter and voltage regulator off when temperature exceeds the TSD trigger level.

NCV7420 has four operating states (normal mode, low slope mode, standby mode, and sleep mode) that are determined by the input signals EN, WAKE, STB, and TxD.

## Operating States

NCV7420 provides four operating states, two modes for normal operation with communication, one standby without communication and one low power mode with very low current consumption. See Figure 3.

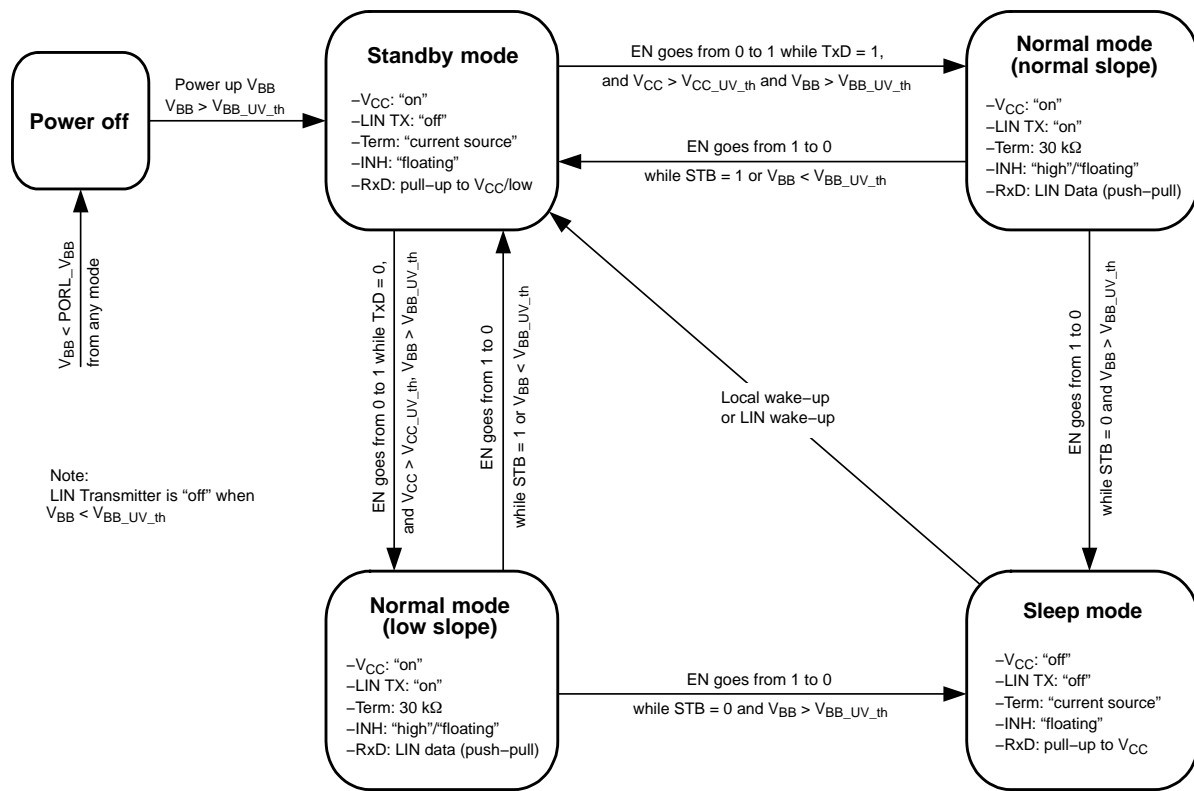

Figure 3. State Diagram

Table 5. MODE SELECTION

Mode	V <sub>CC</sub>	RxD	INH	LIN	30 kΩ on LIN	Note
Normal – Slope	ON	Low = Dominant State High = Recessive State	High if STB=High during state transition; Floating otherwise	Normal Slope	ON	(Note 7)
Normal – Low Slope	ON	Low = Dominant State High = Recessive State	High if STB=High during state transition; Floating otherwise	Low Slope	ON	(Note 8)
Standby	ON	Low after LIN wake-up, high otherwise	Floating	OFF	OFF	(Notes 9 and 10)
Sleep	OFF	Clamped to V <sub>CC</sub>	Floating	OFF	OFF	

7. The normal slope mode is entered when pin EN goes HIGH while TxD is in HIGH state during EN transition.
8. The low slope mode is entered when pin EN goes HIGH while TxD is in LOW state during EN transition. LIN transmitter gets on only after TxD returns to high after the state transition.
9. The standby mode is entered automatically after power-up.
10. In standby mode, RxD High state is achieved by internal pull-up resistor to  $V_{CC}$ .

**Normal Slope Mode**

In normal slope mode the transceiver can transmit and receive data via LIN bus with speed up to 20 kbaud. The transmit data stream of the LIN protocol is present on the TxD pin and converted by the transmitter into a LIN bus signal with controlled slew rate to minimize EMC emission. The receiver consists of the comparator that has a threshold with hysteresis in respect to the supply voltage and an input filter to remove bus noise. The LIN output is pulled HIGH via an internal 30 kΩ pull-up resistor. For master applications it is needed to put an external 1 kΩ resistor with a serial diode between LIN and  $V_{BB}$  (or INH). See Figure 2. The mode selection is done by EN=HIGH when TxD pin is

HIGH. If STB pin is high during the standby-to-normal slope mode transition, INH pin is pulled high. Otherwise, it stays floating.

**Low Slope Mode**

In low slope mode the slew rate of the signal on the LIN bus is reduced (rising and falling edges of the LIN bus signal are longer). This further reduces the EMC emission. As a consequence the maximum speed on the LIN bus is reduced up to 10 kbaud. This mode is suited for applications where the communication speed is not critical. The mode selection is done by EN=HIGH when TxD pin is LOW. In order not to transmit immediately a dominant state on the bus (because

TxD=LOW), the LIN transmitter is enabled only after TxD returns to HIGH. If STB pin is high during the standby-to-low slope mode transition, INH pin is pulled high. Otherwise, it stays floating.

**Standby Mode**

The standby mode is always entered after power-up of the NCV7420. It can also be entered from normal mode when the EN pin is low and the standby pin is high. From sleep mode it can be entered after a local wake-up or LIN wake-up. In standby mode the V<sub>CC</sub> voltage regulator for supplying external components (e.g. a microcontroller) stays active. Also the LIN receiver stays active to be able to detect a remote wake-up via bus. The LIN transmitter is disabled and the slave internal termination resistor of 30 kΩ between LIN and V<sub>BB</sub> is disconnected in order to minimize current consumption. Only a pull-up current source between V<sub>BB</sub> and LIN is active.

**Sleep Mode**

The Sleep Mode provides extreme low current consumption. This mode is entered when both EN and STB pins are LOW coming from normal mode. The internal termination resistor of 30 kΩ between LIN and V<sub>BB</sub> is disconnected and also the V<sub>CC</sub> regulator is switched off to minimize current consumption.

**Wake-up**

NCV7420 has two possibilities to wake-up from sleep or standby mode (see Figure 3):

- Local wake-up: enables the transition from sleep mode to standby mode
- Remote wake-up via LIN: enables the transition from sleep- to standby mode and can be also detected when already in standby mode.

A local wake-up is **only** detected in sleep mode if a transition from LOW to HIGH or from HIGH to LOW is seen on the WAKE pin.

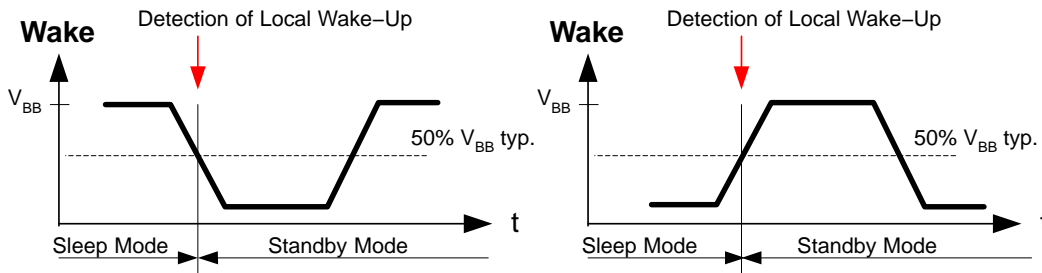

Figure 4. Local Wake-up Signal

A remote wake-up is **only** detected if a combination of (1) a falling edge at the LIN pin (transition from recessive to dominant) is followed by (2) a dominant level maintained

for a time period > t<sub>WAKE</sub> and (3) again a rising edge at pin LIN (transition from dominant to recessive) happens.

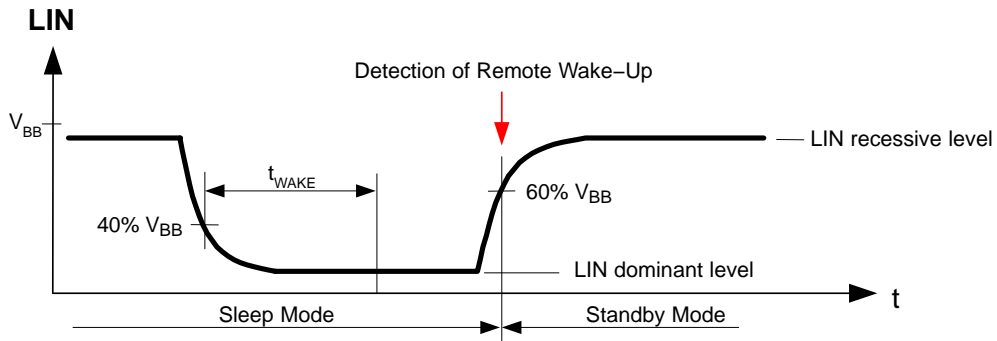

Figure 5. Remote Wake-up Behavior

The wake-up source is distinguished by pin RxD in the standby mode:

- RxD remains HIGH after power-up or local wake-up.
- RxD is kept LOW until normal mode is entered after a remote wake-up (LIN).

# NCV7420

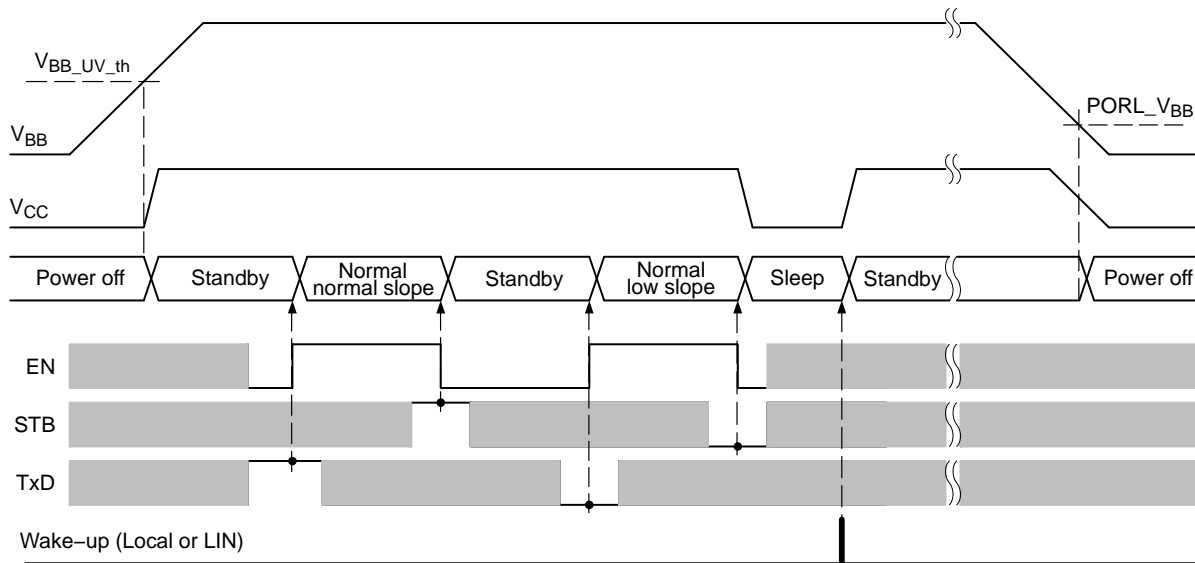

Figure 6. Operating Modes Transitions

# NCV7420

## Electrical Characteristics

### Definitions

All voltages are referenced to GND (Pin 11). Positive currents flow into the IC.

**Table 6. ABSOLUTE MAXIMUM RATINGS – 3.3 V and 5 V versions**

Symbol	Parameter	Min	Max	Unit
$V_{BB}$	Battery voltage on pin $V_{BB}$ (Note 11)	-0.3	+45	V
$V_{CC}$	DC voltage on pin $V_{CC}$	0	+7	V
$I_{VCC}$	Current delivered by the $V_{CC}$ regulator	50		mA
$V_{LIN}$	LIN bus voltage (Note 12)	-45	+45	V
$V_{INH}$	DC voltage on inhibit pin	-0.3	$V_{BB} + 0.3$	V
$V_{WAKE}$	DC voltage on WAKE pin	-45	45	V
$V_{DIG\_IN}$	DC input voltage on pins TxD, RxD, EN, STB	-0.3	$V_{CC} + 0.3$	V
$T_J$	Maximum junction temperature	-40	+165	°C
$V_{ESD}$	Electrostatic discharge voltage on all pins; HBM (Note 13)	-2	+2	kV
	Electrostatic discharge voltage on LIN, INH, WAKE and $V_{BB}$ towards GND; HBM (Note 13)	-4	+4	kV
	Electrostatic discharge on LIN, WAKE and $V_{BB}$ ; system HBM (Note 14)	-8	+8	kV
	Electrostatic discharge voltage on all pins; CDM (Note 16)	-500	+500	V
$V_{ESD}$ (EMC/ESD improved versions)	Electrostatic discharge voltage on all pins; HBM (Note 13)	-4	+4	kV
	Electrostatic discharge voltage on LIN, INH, WAKE and $V_{BB}$ towards GND; HBM (Note 13)	-6	+6	kV
	Electrostatic discharge on LIN, WAKE and $V_{BB}$ ; system HBM (Note 15)	-12	+12	kV
	Electrostatic discharge voltage on all pins; CDM (Note 16)	-750	+750	V

Stresses exceeding those listed in the Maximum Ratings table may damage the device. If any of these limits are exceeded, device functionality should not be assumed, damage may occur and reliability may be affected.

11. The applied transients shall be in accordance with ISO 7637 part 1, test pulses 1, 2, 3a, 3b, and 5. The device complies with functional class C; class A can be reached depending on the application and external components.

12. The applied transients shall be in accordance with ISO 7637 part 1, test pulses 1, 2, 3a, and 3b. The device complies with functional class C; class A can be reached depending on the application and external components.

13. Equivalent to discharging a 100 pF capacitor through a 1500  $\Omega$  resistor.

14. Equivalent to discharging a 150 pF capacitor through a 330  $\Omega$  resistor conform to IEC Standard 61000-4-2. LIN bus filter 220 pF,  $V_{BB}$  blocking capacitor 100 nF, 3k3/10n R/C network on WAKE.

15. Equivalent to discharging a 150 pF capacitor through a 330  $\Omega$  resistor conform to IEC Standard 61000-4-2. No filter on LIN,  $V_{BB}$  blocking capacitor 100 nF, 3k3/10n R/C network on WAKE.

16. Charged device model according ESD-STM5.3.1.



# NCV7420

**Table 7. DC CHARACTERISTICS – 3.3 V version**

( $V_{BB} = 5\text{ V}$  to  $26\text{ V}$ ;  $T_J = -40^\circ\text{C}$  to  $+150^\circ\text{C}$ ; Bus Load =  $500\ \Omega$  ( $V_{BB}$  to LIN); unless otherwise specified.)

Symbol	Parameter	Conditions	Min	Typ	Max	Unit
--------	-----------	------------	-----	-----	-----	------

## SUPPLY – Pin $V_{BB}$

$I_{BB\_ON}$	Supply current	Normal mode; LIN recessive			1.6	mA
$I_{BB\_STB}$	Supply current	Standby mode, $V_{BB} = 5\text{--}18\text{ V}$ , $T_J < 105^\circ\text{C}$			70	$\mu\text{A}$
$I_{BB\_SLP}$	Supply current	Sleep mode, $V_{BB} = 5\text{--}18\text{ V}$ , $T_J < 105^\circ\text{C}$			20	$\mu\text{A}$

## VOLTAGE REGULATOR – Pin $V_{CC}$

$V_{CC\_OUT}$	Regulator output voltage	$V_{CC}$ load 1 mA – 30 mA	3.23	3.30	3.37	V
		$V_{CC}$ load 0 mA – 50 mA	3.19	3.30	3.41	
$I_{OUT\_MAX\_ABS}$	Absolute maximum output current	Thermal shutdown must be taken into account			50	mA
$I_{OUT\_LIM}$	Overcurrent limitation		50	100	170	mA
$\Delta V_{CC\_OUT}$	Line Regulation (Note 22)	$V_{BB} = 5\text{--}26\text{ V}$ , $I_{OUT} = 5\text{ mA}$ , $T_J = 25^\circ\text{C}$		0.5		mV
	Load Regulation (Note 22)	$I_{OUT} = 1\text{--}50\text{ mA}$ , $V_{BB} = 14\text{ V}$ , $T_J = 25^\circ\text{C}$		45		mV
$V_{DO}$	Dropout Voltage ( $V_{BB}\text{--}V_{CC\_OUT}$ ) Figure 11, (Notes 21, 22)	$I_{OUT} = 1\text{ mA}$ , $T_J = 25^\circ\text{C}$		13		mV
		$I_{OUT} = 10\text{ mA}$ , $T_J = 25^\circ\text{C}$		134		mV
		$I_{OUT} = 50\text{ mA}$ , $T_J = 25^\circ\text{C}$		732		mV

## LIN TRANSMITTER – Pin LIN

$V_{LIN\_dom\_LoSup}$	LIN dominant output voltage	TxD = low; $V_{BB} = 7.3\text{ V}$			1.2	V
$V_{LIN\_dom\_HiSup}$	LIN dominant output voltage	TxD = low; $V_{BB} = 18\text{ V}$			2.0	V
$V_{LIN\_REC}$	LIN Recessive Output Voltage (Note 17)	TxD = high; $I_{LIN} = 10\ \mu\text{A}$	$V_{BB} - 1.5$		$V_{BB}$	V
$I_{LIN\_lim}$	Short circuit current limitation	$V_{LIN} = V_{BB\_MAX}$	40		200	mA
$R_{SLAVE}$	Internal pull-up resistance		20	33	47	k $\Omega$
$C_{LIN}$	Capacitance on pin LIN (Note 19)			15	25	pF

## LIN RECEIVER – Pin LIN

$V_{bus\_dom}$	Bus voltage for dominant state				0.4	$V_{BB}$
$V_{bus\_rec}$	Bus voltage for recessive state		0.6			$V_{BB}$
$V_{rec\_dom}$	Receiver threshold	LIN bus recessive $\rightarrow$ dominant	0.4		0.6	$V_{BB}$
$V_{rec\_rec}$	Receiver threshold	LIN bus dominant $\rightarrow$ recessive	0.4		0.6	$V_{BB}$
$V_{rec\_cnt}$	Receiver centre voltage	$(V_{rec\_dom} + V_{rec\_rec}) / 2$	0.475		0.525	$V_{BB}$
$V_{rec\_hys}$	Receiver hysteresis	$(V_{rec\_rec} - V_{rec\_dom})$	0.05		0.175	$V_{BB}$
$I_{LIN\_off\_dom}$	LIN output current bus in dominant state	Driver off; $V_{BB} = 12\text{ V}$ , $V_{LIN} = 0\text{ V}$	-1			mA
$I_{LIN\_off\_rec}$	LIN output current bus in recessive state	Driver off; $V_{BB} < 18\text{ V}$ $V_{BB} < V_{LIN} < 18\text{ V}$			1	$\mu\text{A}$
$I_{LIN\_no\_GND}$	Communication not affected	$V_{BB} = GND = 12\text{ V}$ ; $0 < V_{LIN} < 18\text{ V}$	-1		1	mA

17. The voltage drop in Normal mode between LIN and  $V_{BB}$  pin is the sum of the diode drop and the drop at serial pull-up resistor. The drop at the switch is negligible. See Figure 1.

18. By one of the trimming bits, following reconfiguration can be done during chip-level testing in order to fit the NCV7420-3 into different interface: pins TxD and EN will have typ. 10 k $\Omega$  pull-down resistor to ground and pin WAKE will have typ. 10  $\mu\text{A}$  pull-up current source.

19. Guaranteed by design. Not tested.

20.  $V_{BB}$  undervoltage threshold is always higher than  $V_{BB}$  POR low level ( $V_{BB\_UV\_th} > PORL\_V_{BB}$ )

21. Measured at output voltage  $V_{CC\_OUT} = (V_{CC\_OUT}@V_{BB} = 5\text{ V}) - 2\%$ .

22. Values based on design and characterization. Not tested in production.

# NCV7420

**Table 7. DC CHARACTERISTICS – 3.3 V version**

( $V_{BB} = 5\text{ V}$  to  $26\text{ V}$ ;  $T_J = -40^\circ\text{C}$  to  $+150^\circ\text{C}$ ; Bus Load =  $500\ \Omega$  ( $V_{BB}$  to LIN); unless otherwise specified.)

Symbol	Parameter	Conditions	Min	Typ	Max	Unit
--------	-----------	------------	-----	-----	-----	------

## LIN RECEIVER – Pin LIN

$I_{LIN\_no\_VBB}$	LIN bus remains operational	$V_{BB} = GND = 0\text{ V}$ ; $0 < V_{LIN} < 18\text{ V}$			5	$\mu\text{A}$
--------------------	-----------------------------	--	--	--	---	---------------

## Pin WAKE

$V_{WAKE\_th}$	Threshold voltage		0.35		0.65	$V_{BB}$
$I_{LEAK}$	Input leakage current (Note 18)	$V_{WAKE} = 0\text{ V}$ ; $V_{BB} = 18\text{ V}$	-1	-0.5	1	$\mu\text{A}$
$t_{WAKE\_MIN}$	Debounce time	Sleep mode; rising and falling edge	8		54	$\mu\text{s}$

## Pins TxD and STB

$V_{IL}$	Low level input voltage				0.8	V
$V_{IH}$	High level input voltage		2.0			V
$R_{PU}$	Pull-up resistance to $V_{CC}$ (Note 18)		50		200	$k\Omega$

## Pin INH

$\Delta_{V_H}$	High level voltage drop	$I_{INH} = 15\text{ mA}$		0.35	0.75	V
$I_{LEAK}$	Leakage current	Sleep mode; $V_{INH} = 0\text{ V}$	-1		1	$\mu\text{A}$

## Pin EN

$V_{IL}$	Low level input voltage				0.8	V
$V_{IH}$	High level input voltage		2.0			V
$R_{PD}$	Pull-down resistance to ground (Note 18)		50		200	$k\Omega$

## Pin RxD

$V_{OL}$	Low level output voltage	$I_{SINK} = 2\text{ mA}$			0.65	V
$V_{OH}$	High level output voltage (In Normal mode)	Normal mode, $I_{SOURCE} = -2\text{ mA}$	$V_{CC} - 0.65\text{ V}$			V
$R_{PU}$	Pull-up resistance to $V_{CC}$ (In Standby and Sleep mode)	Standby mode, Sleep mode	5	10	15	$k\Omega$

## POR AND VOLTAGE MONITOR

$V_{BB\_UV\_th}$	$V_{BB}$ undervoltage threshold (Note 20)		3	4.2	4.75	V
$PORL\_V_{BB}$	$V_{BB}$ POR low level comparator	NCV7420D23	2.5		4.2	V
		NCV7420D24	1.7		3.8	V
$V_{CC\_UV\_th}$	$V_{CC}$ undervoltage threshold		2		3	V

## THERMAL SHUTDOWN

$T_{JSD}$	Thermal Shutdown Junction Temperature	For shutdown	165		195	$^\circ\text{C}$
$T_{JSD\_HYST}$	Thermal shutdown hysteresis		9		18	$^\circ\text{C}$

17. The voltage drop in Normal mode between LIN and  $V_{BB}$  pin is the sum of the diode drop and the drop at serial pull-up resistor. The drop at the switch is negligible. See Figure 1.

18. By one of the trimming bits, following reconfiguration can be done during chip-level testing in order to fit the NCV7420-3 into different interface: pins TxD and EN will have typ.  $10\text{ k}\Omega$  pull-down resistor to ground and pin WAKE will have typ.  $10\ \mu\text{A}$  pull-up current source.

19. Guaranteed by design. Not tested.

20.  $V_{BB}$  undervoltage threshold is always higher than  $V_{BB}$  POR low level ( $V_{BB\_UV\_th} > PORL\_V_{BB}$ )

21. Measured at output voltage  $V_{CC\_OUT} = (V_{CC\_OUT}@V_{BB} = 5\text{ V}) - 2\%$ .

22. Values based on design and characterization. Not tested in production.

# NCV7420

**Table 8. DC CHARACTERISTICS – 5 V version**

 ( $V_{BB} = 6\text{ V to }26\text{ V}$ ;  $T_J = -40^\circ\text{C to }+150^\circ\text{C}$ ; Bus Load =  $500\ \Omega$  ( $V_{BB}$  to LIN); unless otherwise specified.)

Symbol	Parameter	Conditions	Min	Typ	Max	Unit
--------	-----------	------------	-----	-----	-----	------

**SUPPLY – Pin  $V_{BB}$** 

$I_{BB\_ON}$	Supply current	Normal mode; LIN recessive			1.6	mA
$I_{BB\_STB}$	Supply current	Standby mode, $V_{BB} = 6\text{--}18\text{ V}$ , $T_J < 105^\circ\text{C}$			70	$\mu\text{A}$
$I_{BB\_SLP}$	Supply current	Sleep mode, $V_{BB} = 6\text{--}18\text{ V}$ , $T_J < 105^\circ\text{C}$			20	$\mu\text{A}$

**VOLTAGE REGULATOR – Pin  $V_{CC}$** 

$V_{CC\_OUT}$	Regulator output voltage	$V_{CC}$ load 1 mA – 30 mA	4.9	5.0	5.1	V
		$V_{CC}$ load 0 mA – 50 mA	4.83	5.0	5.17	
$I_{OUT\_MAX\_ABS}$	Absolute maximum output current	Thermal shutdown must be taken into account			50	mA
$I_{OUT\_LIM}$	Overcurrent limitation		50	100	170	mA
$\Delta V_{CC\_OUT}$	Line Regulation (Note 28)	$V_{BB} = 6\text{--}26\text{ V}$ , $I_{OUT} = 5\text{ mA}$ , $T_J = 25^\circ\text{C}$		0.9		mV
	Load Regulation (Note 28)	$I_{OUT} = 1\text{--}50\text{ mA}$ , $V_{BB} = 14\text{ V}$ , $T_J = 25^\circ\text{C}$		74		mV
$V_{DO}$	Dropout Voltage ( $V_{BB} - V_{CC\_OUT}$ ) Figure 19 (Notes 27, 28)	$I_{OUT} = 1\text{ mA}$ , $T_J = 25^\circ\text{C}$		13		mV
		$I_{OUT} = 10\text{ mA}$ , $T_J = 25^\circ\text{C}$		136		mV
		$I_{OUT} = 50\text{ mA}$ , $T_J = 25^\circ\text{C}$		794		mV

**LIN TRANSMITTER – Pin LIN**

$V_{LIN\_dom\_LoSup}$	LIN dominant output voltage	TxD = low; $V_{BB} = 7.3\text{ V}$			1.2	V
$V_{LIN\_dom\_HiSup}$	LIN dominant output voltage	TxD = low; $V_{BB} = 18\text{ V}$			2.0	V
$V_{LIN\_rec}$	LIN Recessive Output Voltage (Note 23)	TxD = high; $I_{LIN} = 10\ \mu\text{A}$	$V_{BB} - 1.5$		$V_{BB}$	V
$I_{LIN\_lim}$	Short circuit current limitation	$V_{LIN} = V_{BB\_MAX}$	40		200	mA
$R_{SLAVE}$	Internal pull-up resistance		20	33	47	$\text{k}\Omega$
$C_{LIN}$	Capacitance on pin LIN (Note 25)			15	25	pF

**LIN RECEIVER – Pin LIN**

Symbol	Parameter	Conditions	Min	Typ	Max	Unit
$V_{bus\_dom}$	Bus voltage for dominant state				0.4	$V_{BB}$
$V_{bus\_rec}$	Bus voltage for recessive state		0.6			$V_{BB}$
$V_{rec\_dom}$	Receiver threshold	LIN bus recessive $\rightarrow$ dominant	0.4		0.6	$V_{BB}$
$V_{rec\_rec}$	Receiver threshold	LIN bus dominant $\rightarrow$ recessive	0.4		0.6	$V_{BB}$
$V_{rec\_cnt}$	Receiver center voltage	$(V_{rec\_dom} + V_{rec\_rec}) / 2$	0.475		0.525	$V_{BB}$
$V_{rec\_hys}$	Receiver hysteresis	$(V_{rec\_rec} - V_{rec\_dom})$	0.05		0.175	$V_{BB}$
$I_{LIN\_off\_dom}$	LIN output current bus in dominant state	Driver off; $V_{BB} = 12\text{ V}$ ; $V_{LIN} = 0\text{ V}$	-1			mA
$I_{LIN\_off\_rec}$	LIN output current bus in recessive state	Driver off; $V_{BB} < 18\text{ V}$ $V_{BB} < V_{LIN} < 18\text{ V}$			1	$\mu\text{A}$

23. The voltage drop in Normal mode between LIN and  $V_{BB}$  pin is the sum of the diode drop and the drop at serial pull-up resistor. The drop at the switch is negligible. See Figure 1.

24. By one of the trimming bits, following reconfiguration can be done during chip-level testing in order to fit the NCV7420-5 into different interface: pins TxD and EN will have typ.  $10\ \text{k}\Omega$  pull-down resistor to ground and pin WAKE will have typ.  $10\ \mu\text{A}$  pull-up current source.

25. Guaranteed by design. Not tested.

26.  $V_{BB}$  undervoltage threshold is always higher than  $V_{BB}$  POR low level ( $V_{BB\_UV\_th} > \text{PORL\_}V_{BB}$ )

27. Measured at output voltage  $V_{CC\_OUT} = (V_{CC\_OUT}@V_{BB} = 6\text{ V}) - 2\%$ .

28. Values based on design and characterization. Not tested in production.

# NCV7420

**Table 8. DC CHARACTERISTICS – 5 V version**

( $V_{BB} = 6\text{ V}$  to  $26\text{ V}$ ;  $T_J = -40^\circ\text{C}$  to  $+150^\circ\text{C}$ ; Bus Load =  $500\ \Omega$  ( $V_{BB}$  to LIN); unless otherwise specified.)

Symbol	Parameter	Conditions	Min	Typ	Max	Unit
--------	-----------	------------	-----	-----	-----	------

## LIN RECEIVER – Pin LIN

$I_{LIN\_no\_GND}$	Communication not affected	$V_{BB} = GND = 12\text{ V}$ ; $0 < V_{LIN} < 18\text{ V}$	-1		1	mA
$I_{LIN\_no\_VBB}$	LIN bus remains operational	$V_{BB} = GND = 0\text{ V}$ ; $0 < V_{LIN} < 18\text{ V}$			5	$\mu\text{A}$

## Pin WAKE

$V_{WAKE\_th}$	Threshold voltage		0.35		0.65	$V_{BB}$
$I_{LEAK}$	Input leakage current (Note 24)	$V_{WAKE} = 0\text{ V}$ ; $V_{BB} = 18\text{ V}$	-1	-0.5	1	$\mu\text{A}$
$t_{WAKE\_MIN}$	Debounce time	Sleep mode; rising and falling edge	8		54	$\mu\text{s}$

## Pins TxD and STB

$V_{IL}$	Low level input voltage				0.8	V
$V_{IH}$	High level input voltage		2.0			V
$R_{PU}$	Pull-up resistance to $V_{CC}$ (Note 24)		50		200	$\text{k}\Omega$

## Pin INH

$\Delta V_H$	High level voltage drop	$I_{INH} = 15\text{ mA}$		0.35	0.75	V
$I_{LEAK}$	Leakage current	Sleep mode; $V_{INH} = 0\text{ V}$	-1		1	$\mu\text{A}$

## Pin EN

$V_{IL}$	Low level input voltage				0.8	V
$V_{IH}$	High level input voltage		2.0			V
$R_{PD}$	Pull-down resistance to ground (Note 24)		50		200	$\text{k}\Omega$

## Pin RxD

$V_{OL}$	Low level output voltage	$I_{SINK} = 2\text{ mA}$			0.65	V
$V_{OH}$	High level output voltage (In Normal mode)	Normal mode, $I_{SOURCE} = -2\text{ mA}$	$V_{CC} - 0.65\text{ V}$			V
$R_{PU}$	Pull-up resistance to $V_{CC}$ (In Standby and Sleep mode)	Standby mode, Sleep mode	5	10	15	$\text{k}\Omega$

## POR AND VOLTAGE MONITOR

$V_{BB\_UV\_th}$	$V_{BB}$ undervoltage threshold (Note 26)		3	4.2	4.75	V
PORL_ $V_{BB}$	$V_{BB}$ POR low level comparator	NCV7420D25	2.5		4.2	V
		NCV7420D26	1.7		3.8	V
$V_{CC\_UV\_th}$	$V_{CC}$ undervoltage threshold		3		4.5	V

## THERMAL SHUTDOWN

$T_{JSD}$	Thermal Shutdown Junction Temperature	For shutdown	165		195	$^\circ\text{C}$
$T_{JSD\_HYST}$	Thermal shutdown hysteresis		9		18	$^\circ\text{C}$

23. The voltage drop in Normal mode between LIN and  $V_{BB}$  pin is the sum of the diode drop and the drop at serial pull-up resistor. The drop at the switch is negligible. See Figure 1.

24. By one of the trimming bits, following reconfiguration can be done during chip-level testing in order to fit the NCV7420-5 into different interface: pins TxD and EN will have typ.  $10\text{ k}\Omega$  pull-down resistor to ground and pin WAKE will have typ.  $10\ \mu\text{A}$  pull-up current source.

25. Guaranteed by design. Not tested.

26.  $V_{BB}$  undervoltage threshold is always higher than  $V_{BB}$  POR low level ( $V_{BB\_UV\_th} > \text{PORL\_}V_{BB}$ )

27. Measured at output voltage  $V_{CC\_OUT} = (V_{CC\_OUT}@V_{BB} = 6\text{ V}) - 2\%$ .

28. Values based on design and characterization. Not tested in production.

# NCV7420

**AC Characteristics – 3.3 V and 5 V versions –** ( $V_{BB} = 7\text{ V to }18\text{ V}$ ;  $T_J = -40^\circ\text{C to }+150^\circ\text{C}$ ; unless otherwise specified.)

**Table 9. AC CHARACTERISTICS LIN TRANSMITTER – Pin LIN**

Symbol	Parameter	Conditions	Min	Typ	Max	Unit
D1	Duty Cycle 1 = $t_{BUS\_REC(min)} / (2 \times t_{BIT})$ see Figure 23	Normal slope mode $TH_{REC(max)} = 0.744 \times V_{BB}$ $TH_{DOM(max)} = 0.581 \times V_{BB}$ $t_{BIT} = 50\ \mu\text{s}$ $V_{BB} = 7\text{ V to }18\text{ V}$	0.396		0.5	
D2	Duty Cycle 2 = $t_{BUS\_REC(max)} / (2 \times t_{BIT})$ see Figure 23	Normal slope mode $TH_{REC(min)} = 0.422 \times V_{BB}$ $TH_{DOM(min)} = 0.284 \times V_{BB}$ $t_{BIT} = 50\ \mu\text{s}$ $V_{BB} = 7.6\text{ V to }18\text{ V}$	0.5		0.581	
D3	Duty Cycle 3 = $t_{BUS\_REC(min)} / (2 \times t_{BIT})$ see Figure 23	Normal slope mode $TH_{REC(max)} = 0.778 \times V_{BB}$ $TH_{DOM(max)} = 0.616 \times V_{BB}$ $t_{BIT} = 96\ \mu\text{s}$ $V_{BB} = 7\text{ V to }18\text{ V}$	0.417		0.5	
D4	Duty Cycle 4 = $t_{BUS\_REC(max)} / (2 \times t_{BIT})$ see Figure 23	Normal slope mode $TH_{REC(min)} = 0.389 \times V_{BB}$ $TH_{DOM(min)} = 0.251 \times V_{BB}$ $t_{BIT} = 96\ \mu\text{s}$ $V_{BB} = 7.6\text{ V to }18\text{ V}$	0.5		0.590	
$t_{trx\_prop\_down}$	Propagation Delay of TxD to LIN. TxD high to low	(Note 29)			6	$\mu\text{s}$
$t_{trx\_prop\_up}$	Propagation Delay of TxD to LIN. TxD low to high	(Note 29)			6	$\mu\text{s}$
$t_{fall\_norm}$	LIN falling edge	Normal slope mode; $V_{BB} = 12\text{ V}$ ; L1, L2 (Note 30)			22.5	$\mu\text{s}$
$t_{rise\_norm}$	LIN rising edge	Normal slope mode; $V_{BB} = 12\text{ V}$ ; L1, L2 (Note 30)			22.5	$\mu\text{s}$
$t_{sym\_norm}$	LIN slope symmetry	Normal slope mode; $V_{BB} = 12\text{ V}$ ; L1, L2 (Note 30)	-4		4	$\mu\text{s}$
$t_{fall\_norm}$	LIN falling edge	Normal slope mode; $V_{BB} = 12\text{ V}$ ; L3 (Note 30)			27	$\mu\text{s}$
$t_{rise\_norm}$	LIN rising edge	Normal slope mode; $V_{BB} = 12\text{ V}$ ; L3 (Note 30)			27	$\mu\text{s}$
$t_{sym\_norm}$	LIN slope symmetry	Normal slope mode; $V_{BB} = 12\text{ V}$ ; L3 (Note 30)	-5		5	$\mu\text{s}$
$t_{fall\_low}$	LIN falling edge	Low slope mode (Note 31); $V_{BB} = 12\text{ V}$ ; L3 (Note 30)			62	$\mu\text{s}$
$t_{rise\_low}$	LIN rising edge	Low slope mode (Note 31); $V_{BB} = 12\text{ V}$ ; L3 (Note 30)			62	$\mu\text{s}$
$t_{wake}$	Dominant timeout for wake-up via LIN bus		30		150	$\mu\text{s}$
$t_{dom}$	TxD dominant timeout	TxD = low	6		20	ms

29. Values based on design and characterization. Not tested in production.

30. The AC parameters are specified for following RC loads on the LIN bus: L1 = 1 k $\Omega$  / 1 nF; L2 = 660  $\Omega$  / 6.8 nF; L3 = 500  $\Omega$  / 10 nF.

31. Low slope mode is not compliant to the LIN standard.

REGULATOR TYPICAL PERFORMANCE CHARACTERISTICS – 3.3 V VERSION

Load Transient Responses

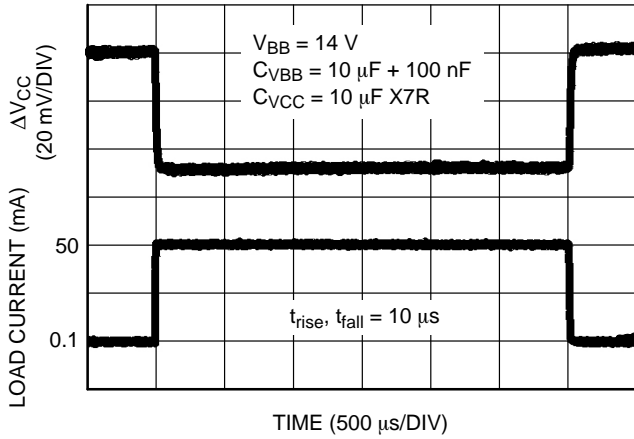

Figure 7. Load Transient Response  
( $I_{CC}$  100  $\mu$ A to 50 mA)

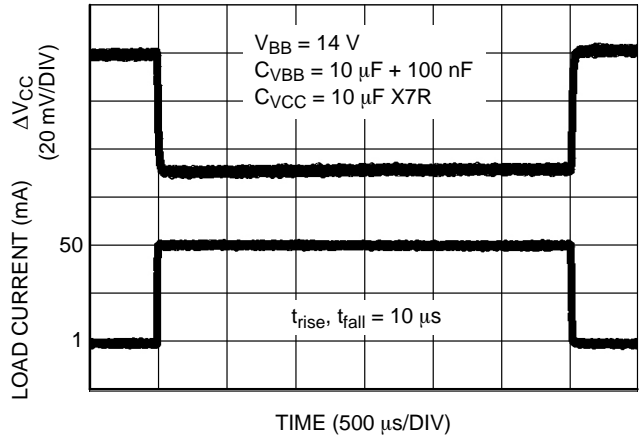

Figure 8. Load Transient Response  
( $I_{CC}$  1 mA to 50 mA)

Line Transient Responses

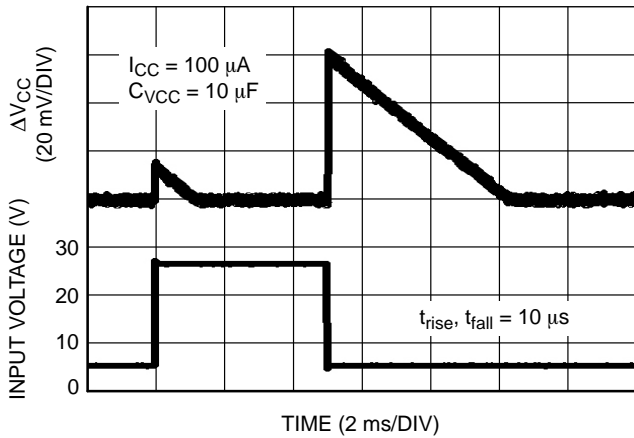

Figure 9. Line Transient Response  
( $V_{BB}$  5 V to 26 V)

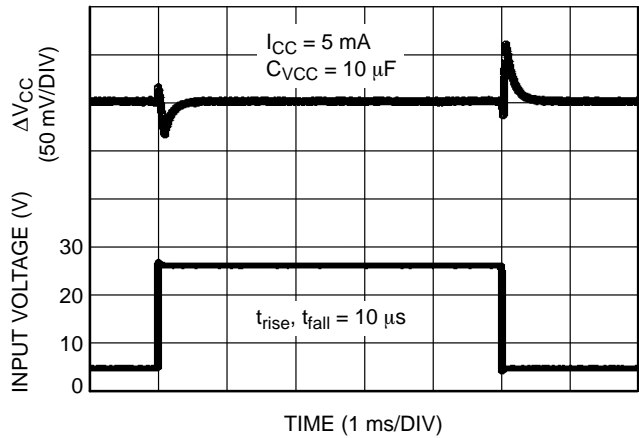

Figure 10. Line Transient Response  
( $V_{BB}$  5 V to 26 V)

REGULATOR TYPICAL PERFORMANCE CHARACTERISTICS – 3.3 V VERSION

Static Characteristics

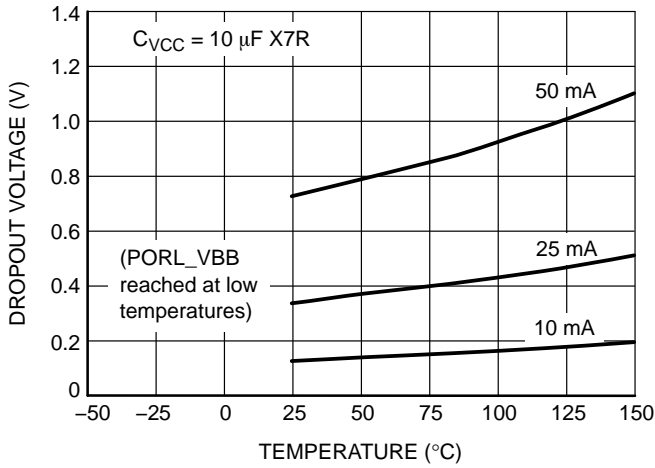

Figure 11. Dropout Voltage vs. Temperature

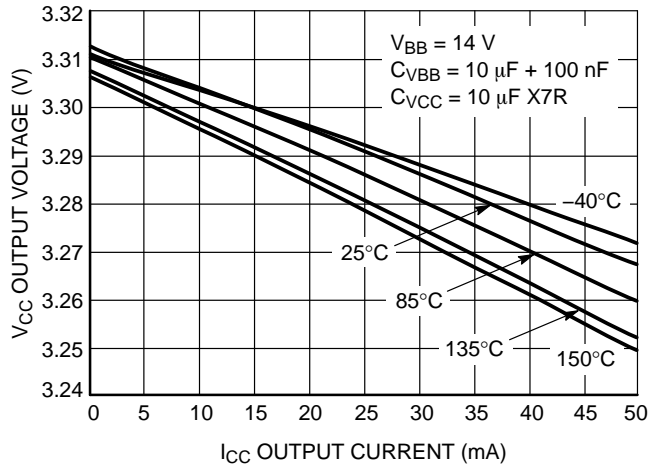

Figure 12. Output Voltage vs. Output Current

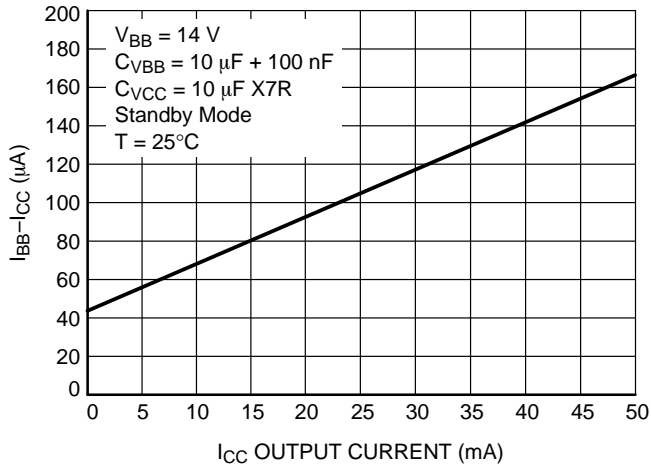

Figure 13. Ground Current vs. Output Current

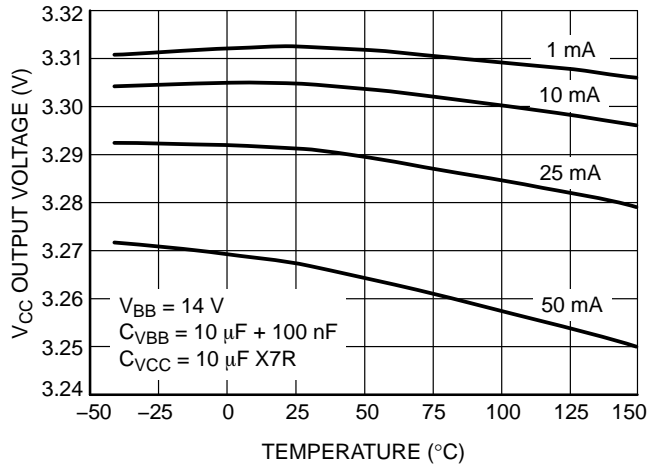

Figure 14. Output Voltage vs. Temperature

REGULATOR TYPICAL PERFORMANCE CHARACTERISTICS – 5 V VERSION

Load Transient Responses

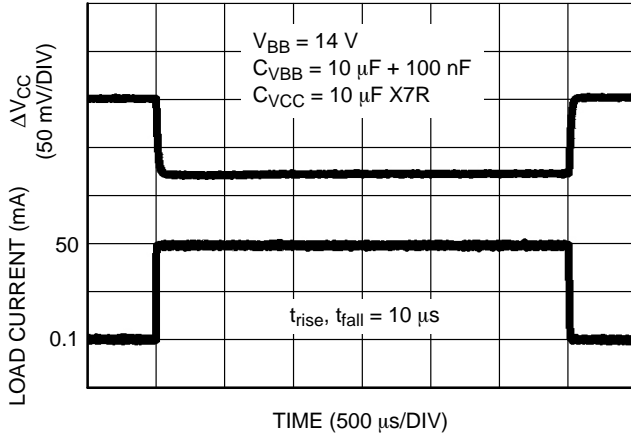

Figure 15. Load Transient Response  
( $I_{CC}$  100  $\mu$ A to 50 mA)

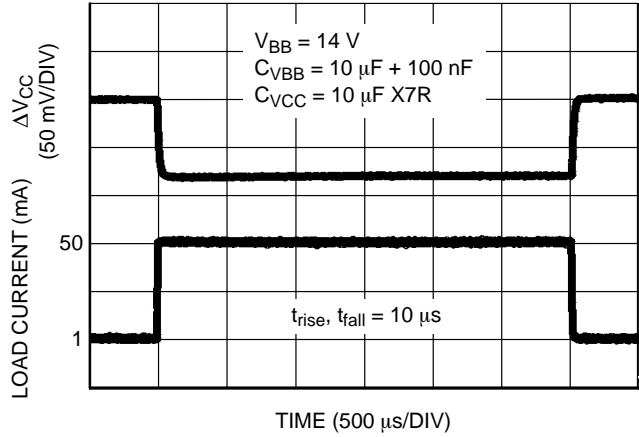

Figure 16. Load Transient Response  
( $I_{CC}$  1 mA to 50 mA)

Line Transient Responses

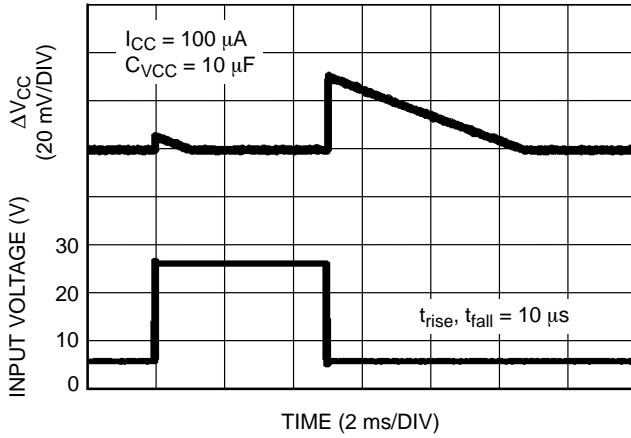

Figure 17. Line Transient Response  
( $V_{BB}$  6 V to 26 V)

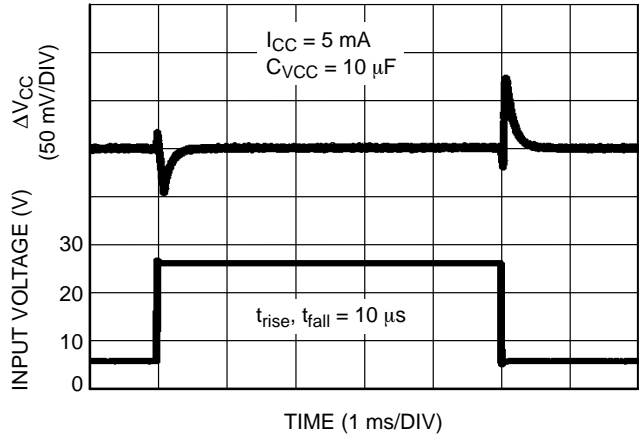

Figure 18. Line Transient Response  
( $V_{BB}$  6 V to 26 V)



REGULATOR TYPICAL PERFORMANCE CHARACTERISTICS – 5 V VERSION

Static Characteristics

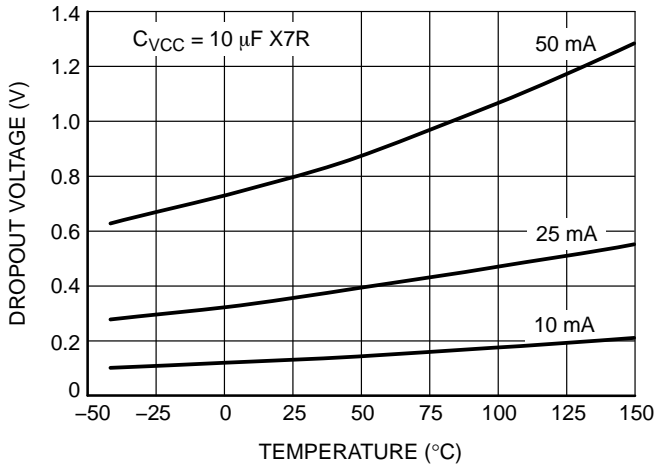

Figure 19. Dropout Voltage vs. Temperature

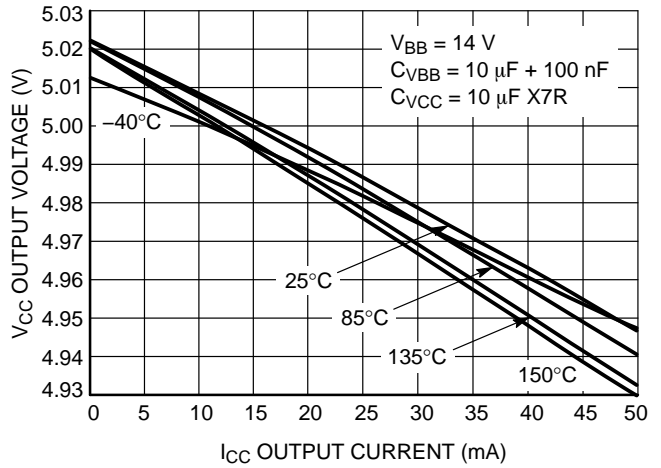

Figure 20. Output Voltage vs. Output Current

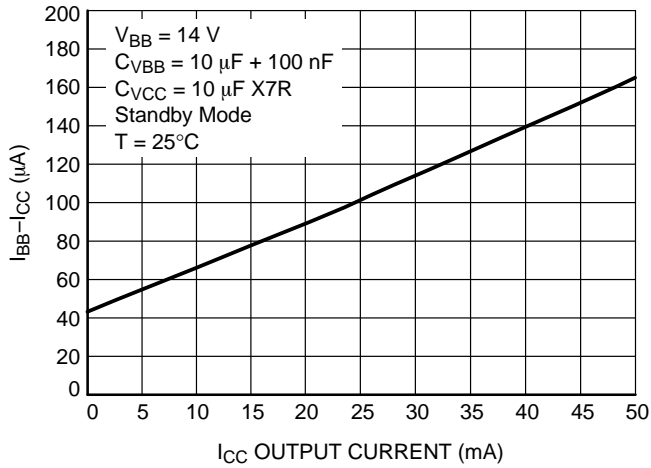

Figure 21. Ground Current vs. Output Current

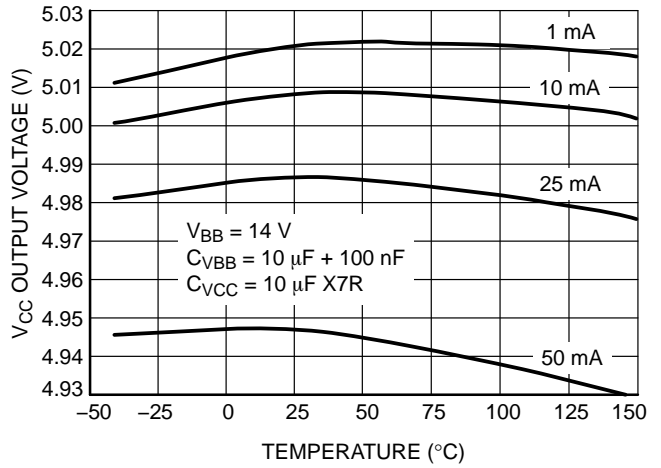

Figure 22. Output Voltage vs. Temperature

# NCV7420

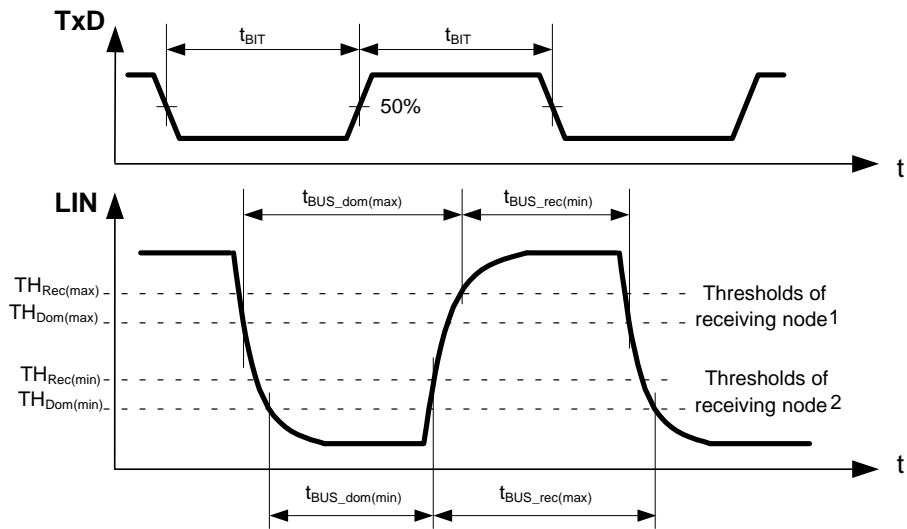

Figure 23. LIN Transmitter Duty Cycle

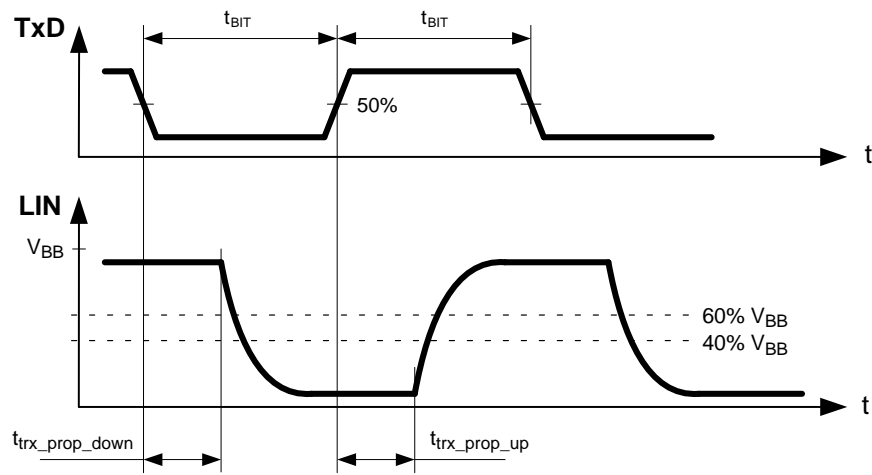

Figure 24. LIN Transmitter Timing

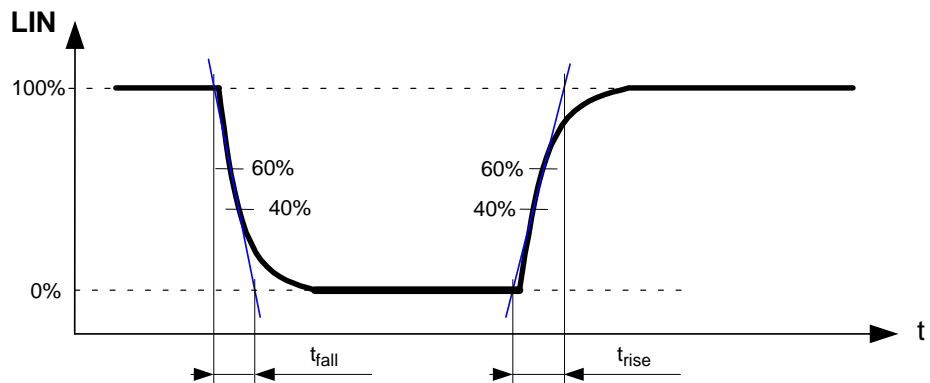
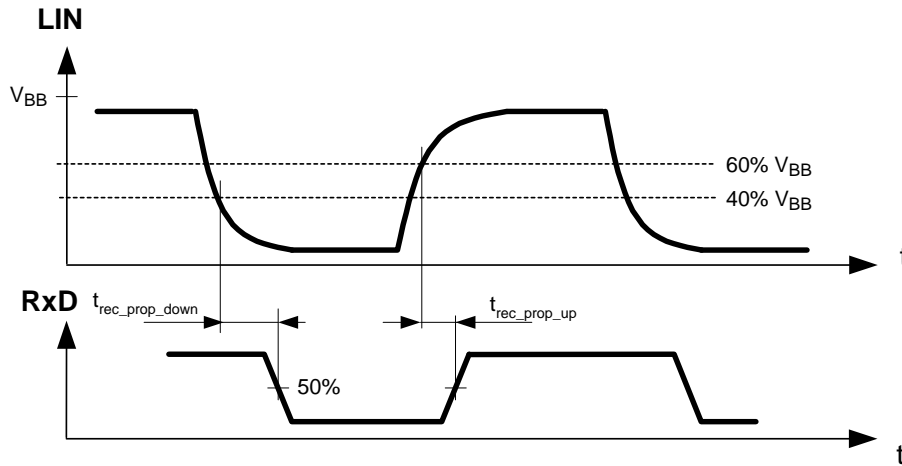

Figure 25. LIN Transmitter Rising and Falling Times

# NCV7420

**Table 10. AC CHARACTERISTICS LIN RECEIVER**

Symbol Pin LIN	Parameter	Conditions	Min	Typ	Max	Unit
$t_{rec\_prop\_down}$	Propagation delay of receiver falling edge		0.1		6	$\mu\text{s}$
$t_{rec\_prop\_up}$	Propagation delay of receiver rising edge		0.1		6	$\mu\text{s}$
$t_{rec\_sym}$	Propagation delay symmetry	$t_{rec\_prop\_down} - t_{rec\_prop\_up}$	-2		2	$\mu\text{s}$



**Figure 26. LIN Receiver Timing**

## ORDERING INFORMATION

Part Number	Description	Temperature Range	Package	Shipping <sup>†</sup>
NCV7420D23G	LIN Transceiver + 3.3 V Vreg.	-40°C to 125°C	SOIC-14 (Pb-Free)	55 / Tube/Rail
NCV7420D23R2G	LIN Transceiver + 3.3 V Vreg.			3000 / Tape & Reel
NCV7420D24G	EMC/ESD Improved LIN Transceiver + 3.3 V Vreg.			55 / Tube/Rail
NCV7420D24R2G	EMC/ESD Improved LIN Transceiver + 3.3 V Vreg.			3000 / Tape & Reel
NCV7420D25G	LIN Transceiver + 5 V Vreg.			55 / Tube/Rail
NCV7420D25R2G	LIN Transceiver + 5 V Vreg.			3000 / Tape & Reel
NCV7420D26G	EMC/ESD Improved LIN Transceiver + 5 V Vreg.			55 / Tube/Rail
NCV7420D26R2G	EMC/ESD Improved LIN Transceiver + 5 V Vreg.			3000 / Tape & Reel

<sup>†</sup>For information on tape and reel specifications, including part orientation and tape sizes, please refer to our Tape and Reel Packaging Specifications Brochure, BRD8011/D.

# MECHANICAL CASE OUTLINE PACKAGE DIMENSIONS

ON Semiconductor®

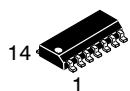

SCALE 1:1

## SOIC-14 CASE 751AP ISSUE B

DATE 18 MAY 2015

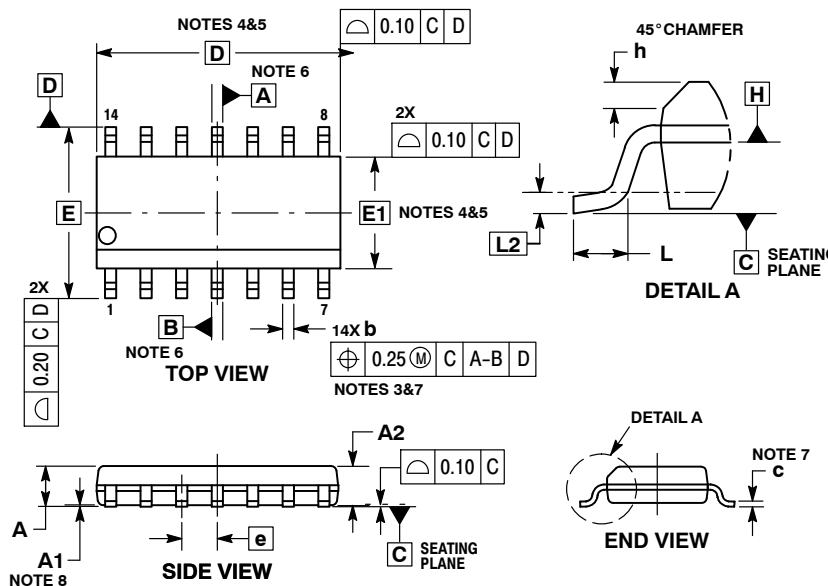

- NOTES:
1. DIMENSIONING AND TOLERANCING PER ASME Y14.5M, 1994.
  2. CONTROLLING DIMENSION: MILLIMETERS.
  3. DIMENSION b DOES NOT INCLUDE DAMBAR PROTRUSION. ALLOWABLE PROTRUSION SHALL BE 0.004 mm IN EXCESS OF MAXIMUM MATERIAL CONDITION.
  4. DIMENSION D DOES NOT INCLUDE MOLD FLASH, PROTRUSIONS OR GATE BURRS. MOLD FLASH, PROTRUSIONS OR GATE BURRS SHALL NOT EXCEED 0.006 mm PER SIDE. DIMENSION E1 DOES NOT INCLUDE INTERLEAD FLASH OR PROTRUSION. INTERLEAD FLASH OR PROTRUSION SHALL NOT EXCEED 0.010 mm PER SIDE.
  5. THE PACKAGE TOP MAY BE SMALLER THAN THE PACKAGE BOTTOM. DIMENSIONS D AND E1 ARE DETERMINED AT THE OUTER-MOST EXTREMES OF THE PLASTIC BODY AT DATUM H.
  6. DIMENSIONS A AND B ARE TO BE DETERMINED AT DATUM H.
  7. DIMENSIONS b AND c APPLY TO THE FLAT SECTION OF THE LEAD BETWEEN 0.10 TO 0.25 FROM THE LEAD TIP.
  8. A1 IS DEFINED AS THE VERTICAL DISTANCE FROM THE SEATING PLANE TO THE LOWEST POINT ON THE PACKAGE BODY.

DIM	MILLIMETERS	
	MIN	MAX
A	---	1.75
A1	0.10	0.25
A2	1.25	---
b	0.31	0.51
c	0.10	0.25
D	8.65 BSC	
E	6.00 BSC	
E1	3.90 BSC	
e	1.27 BSC	
h	0.25	0.41
L	0.40	1.27
L2	0.25 BSC	

### RECOMMENDED SOLDERING FOOTPRINT\*

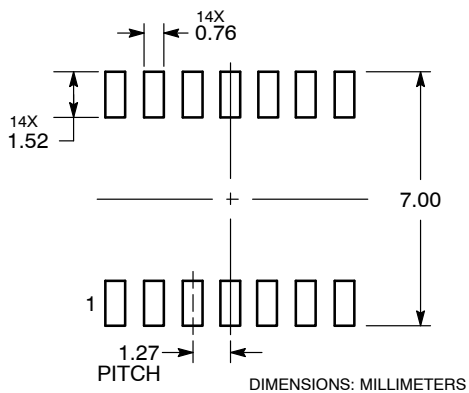

\*For additional information on our Pb-Free strategy and soldering details, please download the ON Semiconductor Soldering and Mounting Techniques Reference Manual, SOLDERRM/D.

### GENERIC MARKING DIAGRAM\*

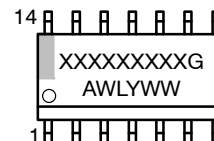

- XXXXXX = Specific Device Code
- A = Assembly Location
- WL = Wafer Lot
- Y = Year
- WW = Work Week
- G = Pb-Free Package

\*This information is generic. Please refer to device data sheet for actual part marking. Pb-Free indicator, "G" or microdot "▪", may or may not be present.

DOCUMENT NUMBER:	98AON30871E	Electronic versions are uncontrolled except when accessed directly from the Document Repository. Printed versions are uncontrolled except when stamped "CONTROLLED COPY" in red.
DESCRIPTION:	SOIC-14	PAGE 1 OF 1

ON Semiconductor and are trademarks of Semiconductor Components Industries, LLC dba ON Semiconductor or its subsidiaries in the United States and/or other countries. ON Semiconductor reserves the right to make changes without further notice to any products herein. ON Semiconductor makes no warranty, representation or guarantee regarding the suitability of its products for any particular purpose, nor does ON Semiconductor assume any liability arising out of the application or use of any product or circuit, and specifically disclaims any and all liability, including without limitation special, consequential or incidental damages. ON Semiconductor does not convey any license under its patent rights nor the rights of others.

**onsemi**, **Onsemi**, and other names, marks, and brands are registered and/or common law trademarks of Semiconductor Components Industries, LLC dba "**onsemi**" or its affiliates and/or subsidiaries in the United States and/or other countries. **onsemi** owns the rights to a number of patents, trademarks, copyrights, trade secrets, and other intellectual property. A listing of **onsemi**'s product/patent coverage may be accessed at [www.onsemi.com/site/pdf/Patent-Marking.pdf](http://www.onsemi.com/site/pdf/Patent-Marking.pdf). **onsemi** reserves the right to make changes at any time to any products or information herein, without notice. The information herein is provided "as-is" and **onsemi** makes no warranty, representation or guarantee regarding the accuracy of the information, product features, availability, functionality, or suitability of its products for any particular purpose, nor does **onsemi** assume any liability arising out of the application or use of any product or circuit, and specifically disclaims any and all liability, including without limitation special, consequential or incidental damages. Buyer is responsible for its products and applications using **onsemi** products, including compliance with all laws, regulations and safety requirements or standards, regardless of any support or applications information provided by **onsemi**. "Typical" parameters which may be provided in **onsemi** data sheets and/or specifications can and do vary in different applications and actual performance may vary over time. All operating parameters, including "Typicals" must be validated for each customer application by customer's technical experts. **onsemi** does not convey any license under any of its intellectual property rights nor the rights of others. **onsemi** products are not designed, intended, or authorized for use as a critical component in life support systems or any FDA Class 3 medical devices or medical devices with a same or similar classification in a foreign jurisdiction or any devices intended for implantation in the human body. Should Buyer purchase or use **onsemi** products for any such unintended or unauthorized application, Buyer shall indemnify and hold **onsemi** and its officers, employees, subsidiaries, affiliates, and distributors harmless against all claims, costs, damages, and expenses, and reasonable attorney fees arising out of, directly or indirectly, any claim of personal injury or death associated with such unintended or unauthorized use, even if such claim alleges that **onsemi** was negligent regarding the design or manufacture of the part. **onsemi** is an Equal Opportunity/Affirmative Action Employer. This literature is subject to all applicable copyright laws and is not for resale in any manner.

## PUBLICATION ORDERING INFORMATION

### LITERATURE FULFILLMENT:

Email Requests to: [orderlit@onsemi.com](mailto:orderlit@onsemi.com)

**onsemi Website:** [www.onsemi.com](http://www.onsemi.com)

### TECHNICAL SUPPORT

**North American Technical Support:**

Voice Mail: 1 800-282-9855 Toll Free USA/Canada

Phone: 011 421 33 790 2910

**Europe, Middle East and Africa Technical Support:**

Phone: 00421 33 790 2910

For additional information, please contact your local Sales Representative