

# NGTB15N120IHLWG

## IGBT

This Insulated Gate Bipolar Transistor (IGBT) features a robust and cost effective Field Stop (FS) Trench construction, and provides superior performance in demanding switching applications, offering both low on-state voltage and minimal switching loss. The IGBT is well suited for resonant or soft switching applications. Incorporated into the device is a rugged co-packaged free wheeling diode with a low forward voltage.

### Features

- Low Saturation Voltage using Trench with Fieldstop Technology
- Low Switching Loss Reduces System Power Dissipation
- Optimized for Low Case Temperature in IH Cooker Application
- Low Gate Charge
- These are Pb-Free Devices

### Typical Applications

- Inductive Heating
- Consumer Appliances
- Soft Switching

### ABSOLUTE MAXIMUM RATINGS

Rating	Symbol	Value	Unit
Collector-emitter voltage	$V_{CES}$	1200	V
Collector current @ $T_C = 25^\circ\text{C}$ @ $T_C = 100^\circ\text{C}$	$I_C$	30 15	A
Pulsed collector current, $T_{\text{pulse}}$ limited by $T_{J\text{max}}$	$I_{CM}$	120	A
Diode forward current @ $T_C = 25^\circ\text{C}$ @ $T_C = 100^\circ\text{C}$	$I_F$	30 15	A
Diode pulsed current, $T_{\text{pulse}}$ limited by $T_{J\text{max}}$	$I_{FM}$	100	A
Gate-emitter voltage	$V_{GE}$	$\pm 20$	V
Power Dissipation @ $T_C = 25^\circ\text{C}$ @ $T_C = 100^\circ\text{C}$	$P_D$	156 62.5	W
Operating junction temperature range	$T_J$	-55 to +150	$^\circ\text{C}$
Storage temperature range	$T_{\text{stg}}$	-55 to +150	$^\circ\text{C}$
Lead temperature for soldering, 1/8" from case for 5 seconds	$T_{\text{SLD}}$	260	$^\circ\text{C}$

Stresses exceeding Maximum Ratings may damage the device. Maximum Ratings are stress ratings only. Functional operation above the Recommended Operating Conditions is not implied. Extended exposure to stresses above the Recommended Operating Conditions may affect device reliability.



**ON Semiconductor®**

<http://onsemi.com>

**15 A, 1200 V**  
 $V_{CESat} = 1.8 \text{ V}$   
 $E_{off} = 0.56 \text{ mJ}$

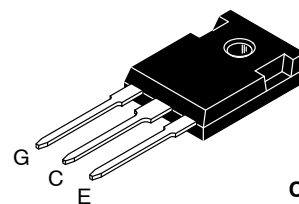
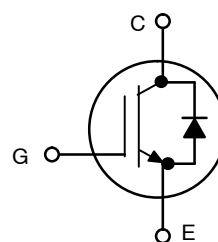

**TO-247  
CASE 340L  
STYLE 4**

### MARKING DIAGRAM

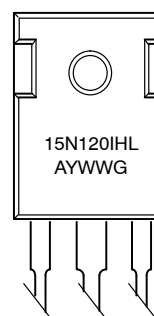

A = Assembly Location  
 Y = Year  
 WW = Work Week  
 G = Pb-Free Package

### ORDERING INFORMATION

Device	Package	Shipping
NGTB15N120IHLWG	TO-247 (Pb-Free)	30 Units / Rail

# NGTB15N120IHLWG

## THERMAL CHARACTERISTICS

Rating	Symbol	Value	Unit
Thermal resistance junction-to-case, for IGBT	$R_{\theta JC}$	0.8	$^{\circ}\text{C}/\text{W}$
Thermal resistance junction-to-case, for Diode	$R_{\theta JC}$	2.0	$^{\circ}\text{C}/\text{W}$
Thermal resistance junction-to-ambient	$R_{\theta JA}$	60	$^{\circ}\text{C}/\text{W}$

## ELECTRICAL CHARACTERISTICS ( $T_J = 25^{\circ}\text{C}$ unless otherwise specified)

Parameter	Test Conditions	Symbol	Min	Typ	Max	Unit
-----------	-----------------	--------	-----	-----	-----	------

### STATIC CHARACTERISTIC

Collector-emitter breakdown voltage, gate-emitter short-circuited	$V_{GE} = 0\text{ V}, I_C = 500\ \mu\text{A}$	$V_{(BR)CES}$	1200	-	-	V
Collector-emitter saturation voltage	$V_{GE} = 15\text{ V}, I_C = 15\text{ A}$ $V_{GE} = 15\text{ V}, I_C = 15\text{ A}, T_J = 150^{\circ}\text{C}$	$V_{CEsat}$	-	1.8 2.0	2.2 -	V
Gate-emitter threshold voltage	$V_{GE} = V_{CE}, I_C = 150\ \mu\text{A}$	$V_{GE(th)}$	4.5	5.5	6.5	V
Collector-emitter cut-off current, gate-emitter short-circuited	$V_{GE} = 0\text{ V}, V_{CE} = 1200\text{ V}$ $V_{GE} = 0\text{ V}, V_{CE} = 1200\text{ V}, T_J = 150^{\circ}\text{C}$	$I_{CES}$	-	-	0.5 2.0	mA
Gate leakage current, collector-emitter short-circuited	$V_{GE} = 20\text{ V}, V_{CE} = 0\text{ V}$	$I_{GES}$	-	-	100	nA

### DYNAMIC CHARACTERISTIC

Input capacitance	$V_{CE} = 20\text{ V}, V_{GE} = 0\text{ V}, f = 1\text{ MHz}$	$C_{ies}$	-	3600	-	pF
Output capacitance		$C_{oes}$	-	88	-	
Reverse transfer capacitance		$C_{res}$	-	63	-	
Gate charge total	$V_{CE} = 600\text{ V}, I_C = 15\text{ A}, V_{GE} = 15\text{ V}$	$Q_g$		160		nC
Gate to emitter charge		$Q_{ge}$		30		
Gate to collector charge		$Q_{gc}$		73		

### SWITCHING CHARACTERISTIC, INDUCTIVE LOAD

Turn-off delay time	$T_J = 25^{\circ}\text{C}$ $V_{CC} = 600\text{ V}, I_C = 15\text{ A}$ $R_g = 15\ \Omega$ $V_{GE} = 0\text{ V}/15\text{ V}$	$t_{d(off)}$		165		ns
Fall time		$t_f$		200		
Turn-off switching loss		$E_{off}$		0.56		
Turn-off delay time	$T_J = 125^{\circ}\text{C}$ $V_{CC} = 600\text{ V}, I_C = 15\text{ A}$ $R_g = 15\ \Omega$ $V_{GE} = 0\text{ V}/15\text{ V}$	$t_{d(off)}$		180		ns
Fall time		$t_f$		260		
Turn-off switching loss		$E_{off}$		0.95		

### DIODE CHARACTERISTIC

Forward voltage	$V_{GE} = 0\text{ V}, I_F = 15\text{ A}$ $V_{GE} = 0\text{ V}, I_F = 15\text{ A}, T_J = 150^{\circ}\text{C}$	$V_F$		1.4 1.5	1.6	V
-----------------	---	-------	--	------------	-----	---

# NGTB15N120IHLWG

## TYPICAL CHARACTERISTICS

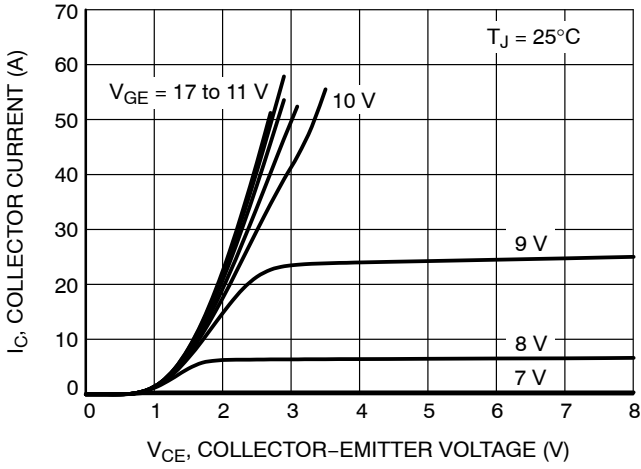

Figure 1. Output Characteristics

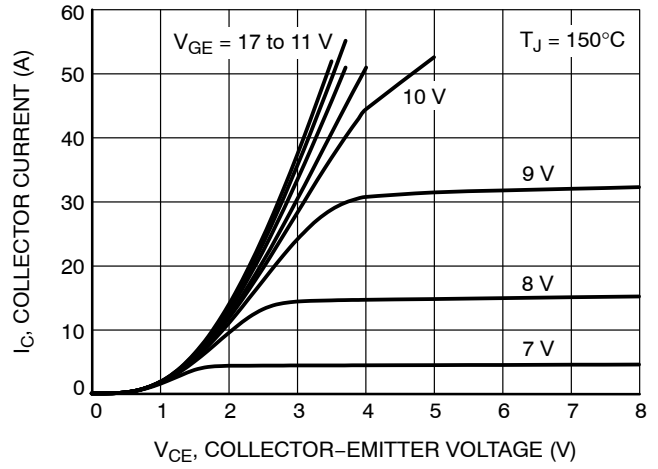

Figure 2. Output Characteristics

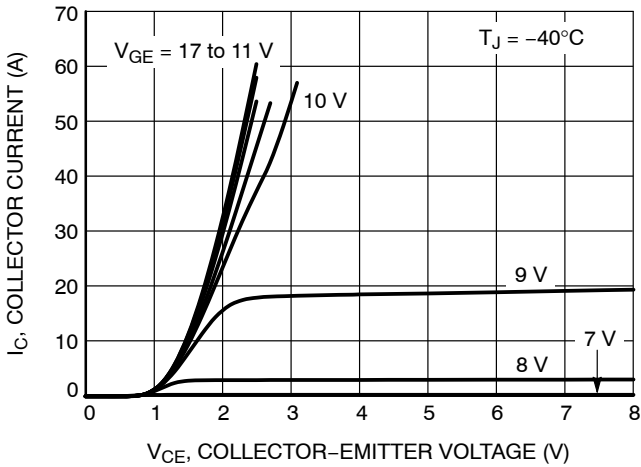

Figure 3. Output Characteristics

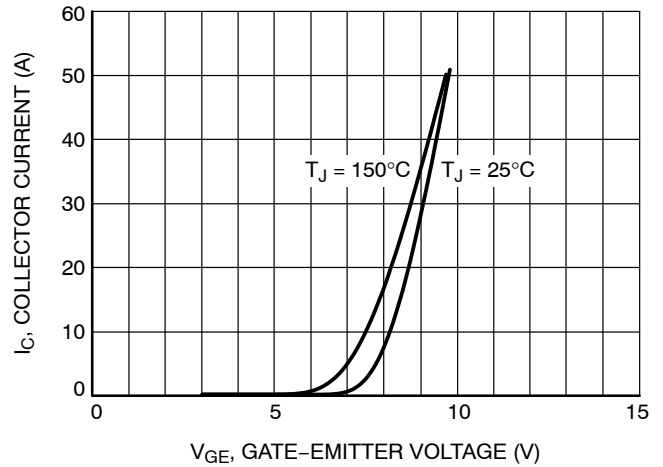

Figure 4. Typical Transfer Characteristics

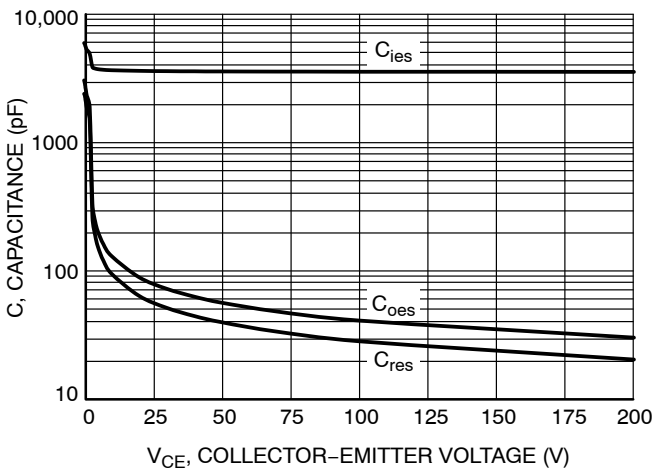

Figure 5. Typical Capacitance

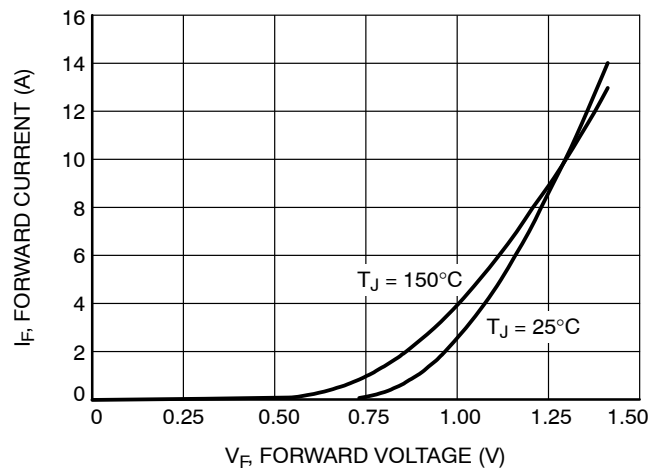

Figure 6. Diode Forward Characteristics

# NGTB15N120IHLWG

## TYPICAL CHARACTERISTICS

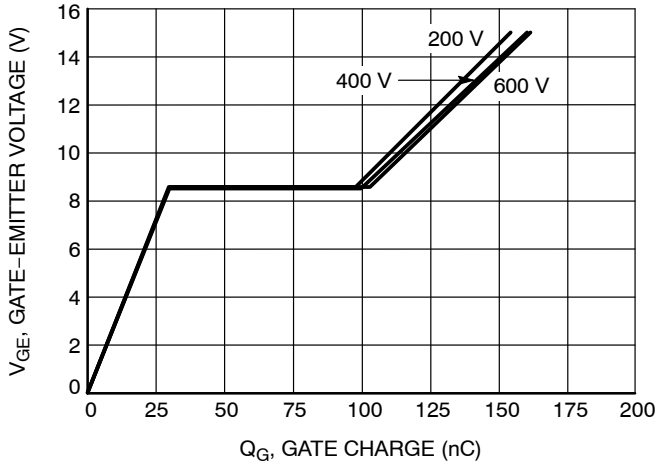

Figure 7. Typical Gate Charge

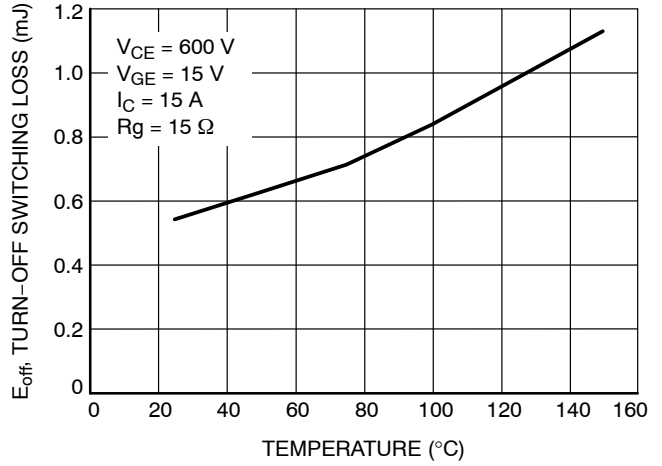

Figure 8. Energy Loss vs. Temperature

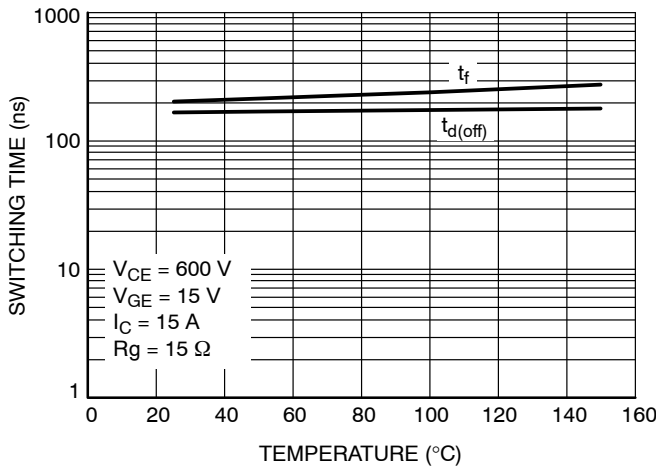

Figure 9. Switching Time vs. Temperature

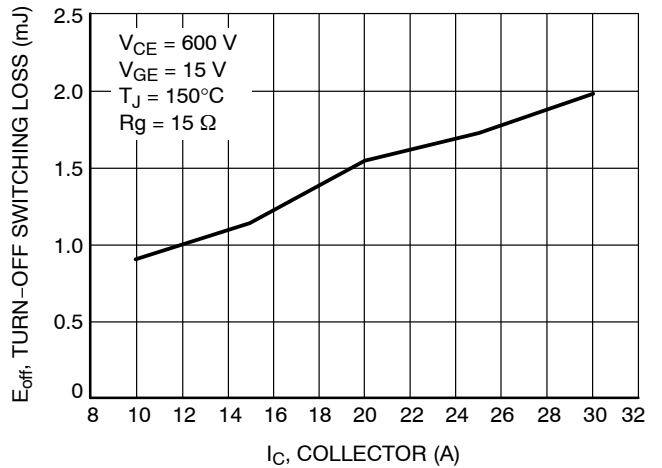

Figure 10. Energy Loss vs. IC

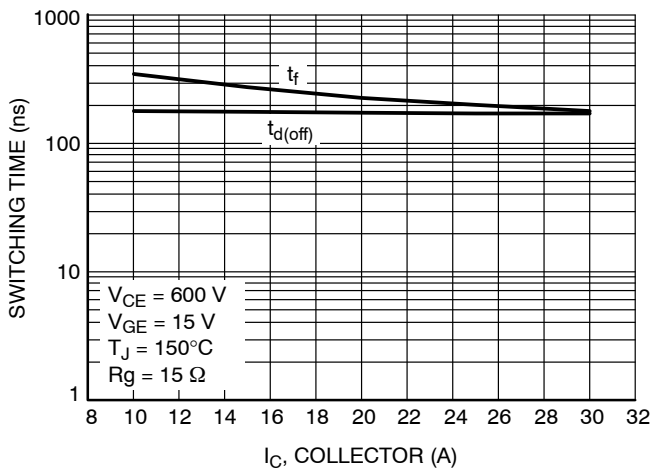

Figure 11. Switching Time vs. IC

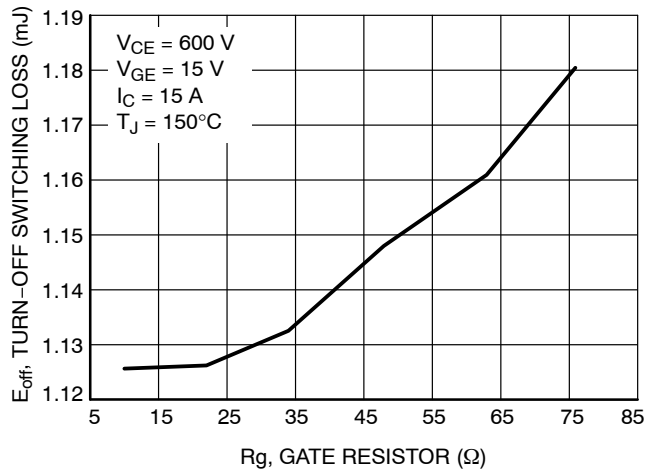

Figure 12. Energy Loss vs. Rg

# NGTB15N120HLWG

## TYPICAL CHARACTERISTICS

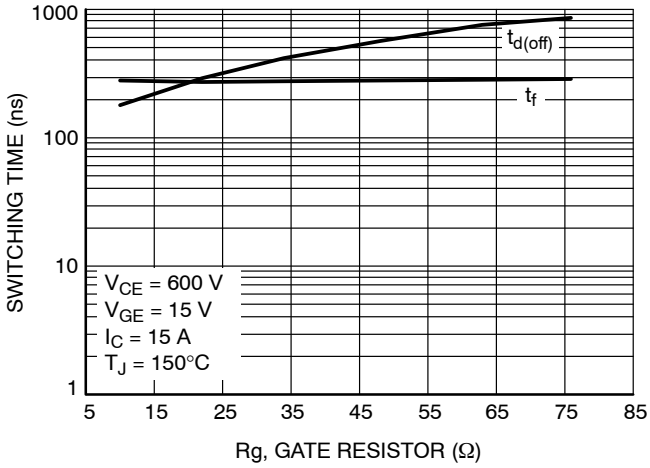

Figure 13. Switching Time vs.  $R_g$

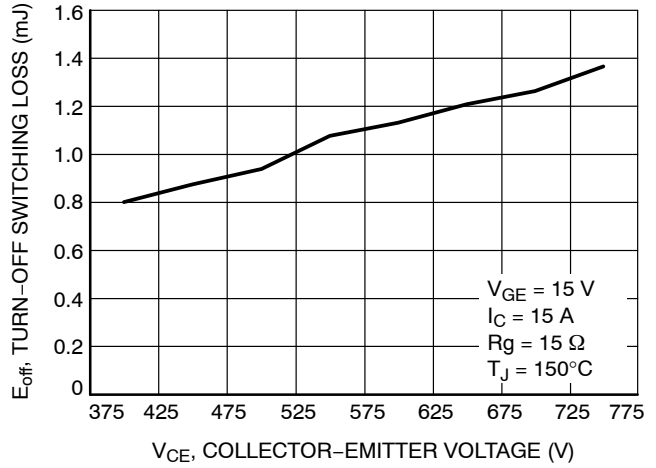

Figure 14. Energy Loss vs.  $V_{CE}$

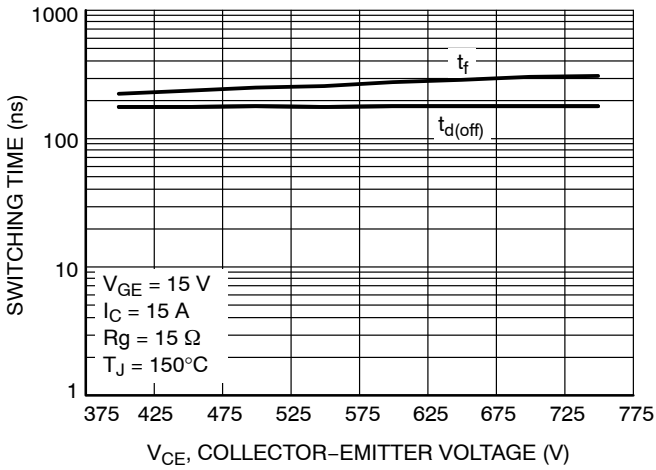

Figure 15. Switching Time vs.  $V_{CE}$

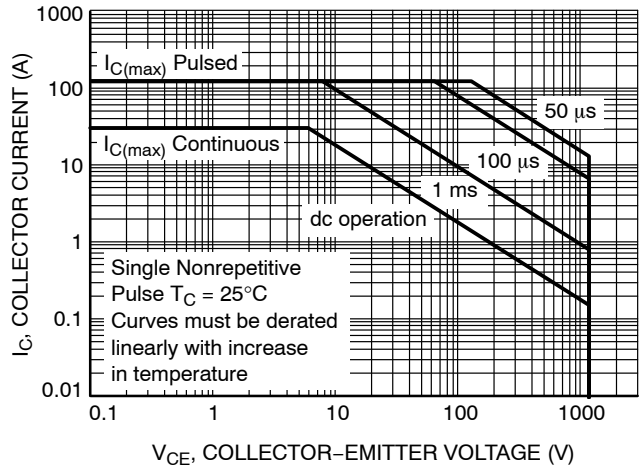

Figure 16. Safe Operating Area

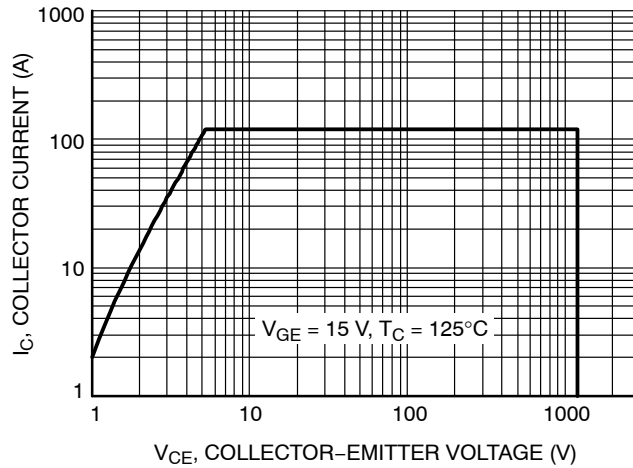

Figure 17. Reverse Bias Safe Operating Area

# NGTB15N120HLWG

## TYPICAL CHARACTERISTICS

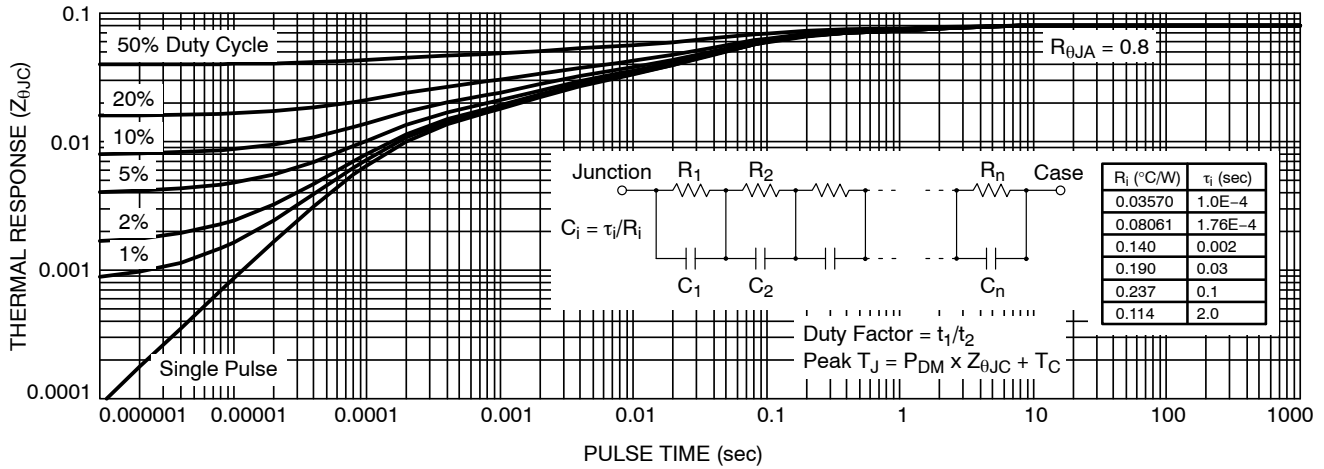

Figure 18. IGBT Transient Thermal Impedance

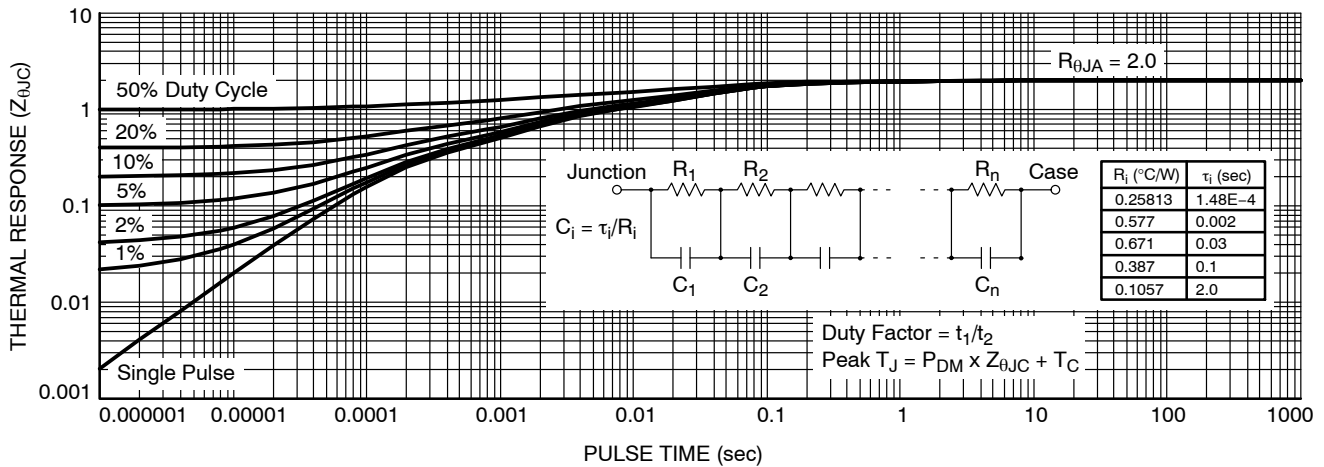

Figure 19. Diode Transient Thermal Impedance

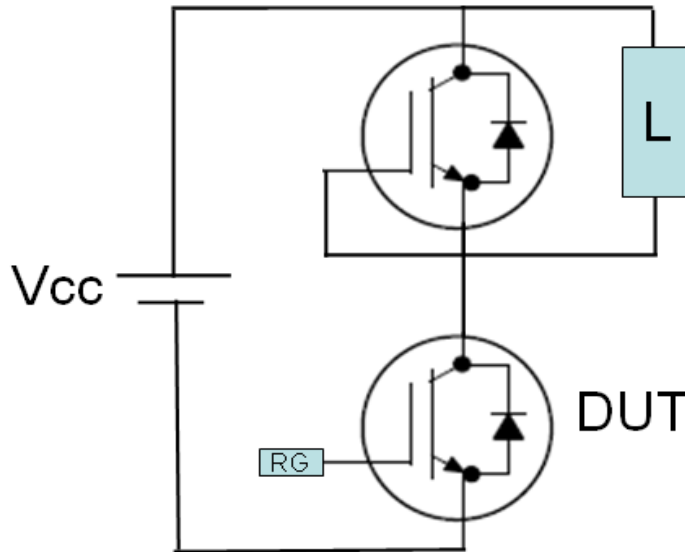

Figure 20. Test Circuit for Switching Characteristics

# NGTB15N120IHLWG

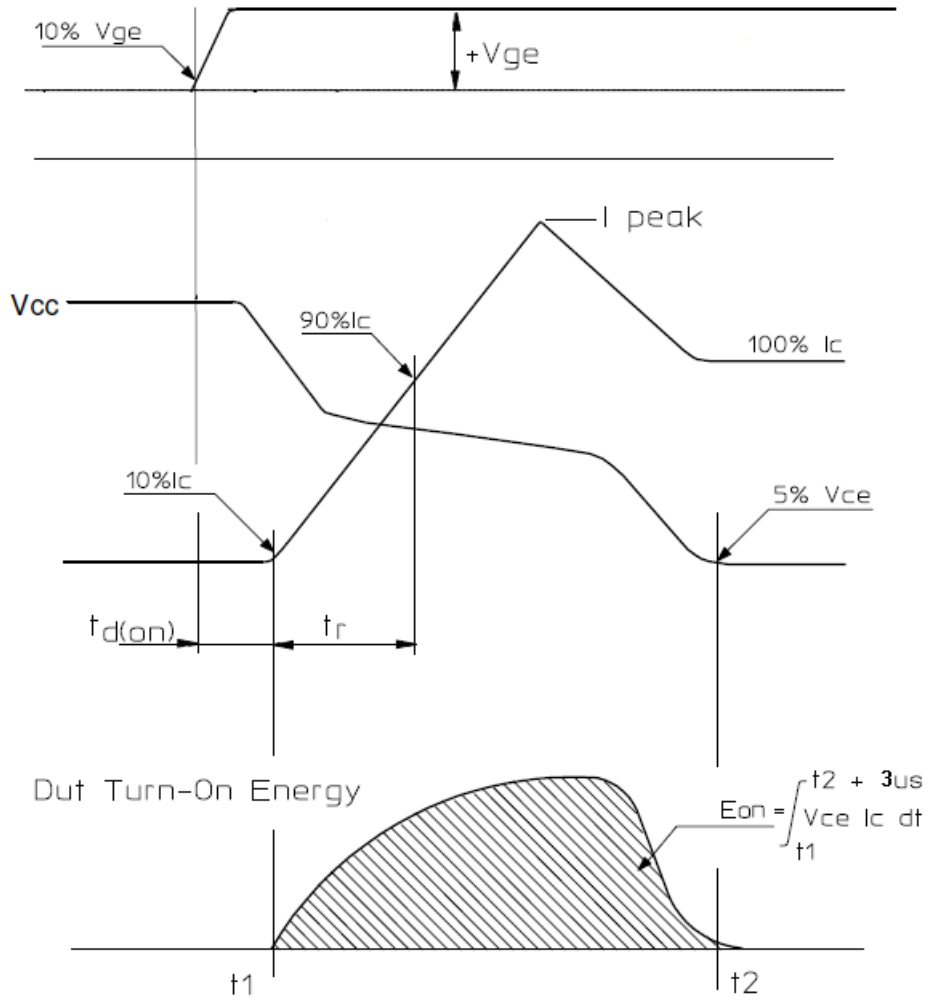

Figure 21. Definition of Turn On Waveform

# NGTB15N120IHLWG

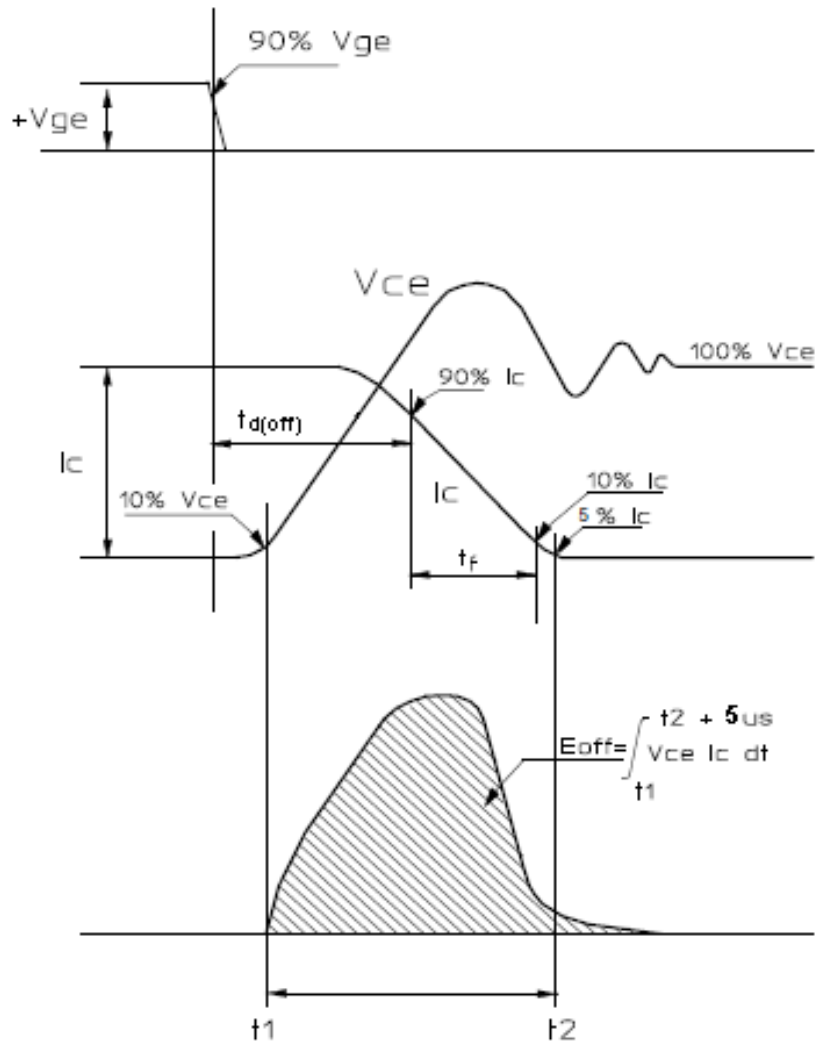
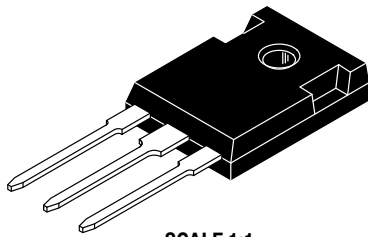

Figure 22. Definition of Turn Off Waveform



# MECHANICAL CASE OUTLINE PACKAGE DIMENSIONS



TO-247  
CASE 340L  
ISSUE G

DATE 06 OCT 2021

SCALE 1:1

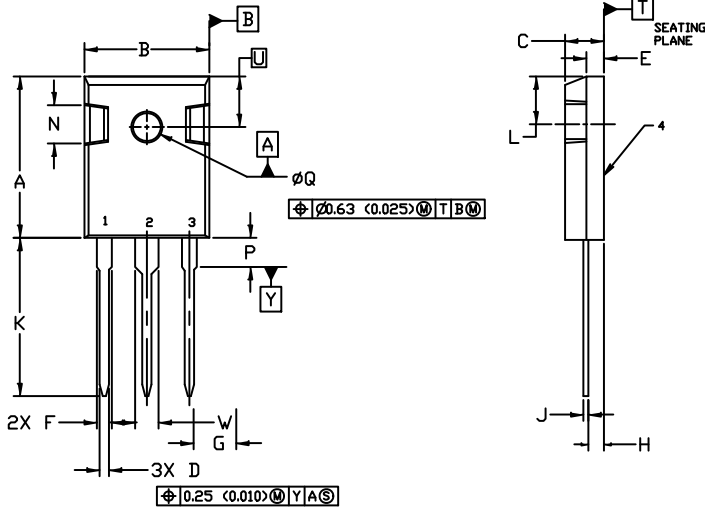

NOTES:

1. DIMENSIONING AND TOLERANCING PER ASME Y14.5M, 1982.
2. CONTROLLING DIMENSION: MILLIMETER

DIM	MILLIMETERS		INCHES	
	MIN.	MAX.	MIN.	MAX.
A	20.32	21.08	0.800	0.830
B	15.75	16.26	0.620	0.640
C	4.70	5.30	0.185	0.209
D	1.00	1.40	0.040	0.055
E	1.90	2.60	0.075	0.102
F	1.65	2.13	0.065	0.084
G	5.45 BSC		0.215 BSC	
H	1.50	2.49	0.059	0.098
J	0.40	0.80	0.016	0.031
K	19.81	20.83	0.780	0.820
L	5.40	6.20	0.212	0.244
N	4.32	5.49	0.170	0.216
P	----	4.50	----	0.177
Q	3.55	3.65	0.140	0.144
U	6.15 BSC		0.242 BSC	
W	2.87	3.12	0.113	0.123

GENERIC  
MARKING DIAGRAM\*

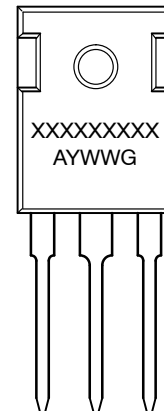

- |  |  |  |  |
|--|--|--|--|
| <p>STYLE 1:<br/>PIN 1. GATE<br/>2. DRAIN<br/>3. SOURCE<br/>4. DRAIN</p>  | <p>STYLE 2:<br/>PIN 1. ANODE<br/>2. CATHODE (S)<br/>3. ANODE 2<br/>4. CATHODES (S)</p>               | <p>STYLE 3:<br/>PIN 1. BASE<br/>2. COLLECTOR<br/>3. EMITTER<br/>4. COLLECTOR</p> | <p>STYLE 4:<br/>PIN 1. GATE<br/>2. COLLECTOR<br/>3. EMITTER<br/>4. COLLECTOR</p> |
| <p>STYLE 5:<br/>PIN 1. CATHODE<br/>2. ANODE<br/>3. GATE<br/>4. ANODE</p> | <p>STYLE 6:<br/>PIN 1. MAIN TERMINAL 1<br/>2. MAIN TERMINAL 2<br/>3. GATE<br/>4. MAIN TERMINAL 2</p> |  |  |

- XXXXX = Specific Device Code  
A = Assembly Location  
Y = Year  
WW = Work Week  
G = Pb-Free Package

\*This information is generic. Please refer to device data sheet for actual part marking. Pb-Free indicator, "G" or microdot "▪", may or may not be present. Some products may not follow the Generic Marking.

DOCUMENT NUMBER:	98ASB15080C	Electronic versions are uncontrolled except when accessed directly from the Document Repository. Printed versions are uncontrolled except when stamped "CONTROLLED COPY" in red.
DESCRIPTION:	TO-247	PAGE 1 OF 1

onsemi and ONSEMI are trademarks of Semiconductor Components Industries, LLC dba onsemi or its subsidiaries in the United States and/or other countries. onsemi reserves the right to make changes without further notice to any products herein. onsemi makes no warranty, representation or guarantee regarding the suitability of its products for any particular purpose, nor does onsemi assume any liability arising out of the application or use of any product or circuit, and specifically disclaims any and all liability, including without limitation special, consequential or incidental damages. onsemi does not convey any license under its patent rights nor the rights of others.

**onsemi**, **Onsemi**, and other names, marks, and brands are registered and/or common law trademarks of Semiconductor Components Industries, LLC dba "**onsemi**" or its affiliates and/or subsidiaries in the United States and/or other countries. **onsemi** owns the rights to a number of patents, trademarks, copyrights, trade secrets, and other intellectual property. A listing of **onsemi**'s product/patent coverage may be accessed at [www.onsemi.com/site/pdf/Patent-Marking.pdf](http://www.onsemi.com/site/pdf/Patent-Marking.pdf). **onsemi** reserves the right to make changes at any time to any products or information herein, without notice. The information herein is provided "as-is" and **onsemi** makes no warranty, representation or guarantee regarding the accuracy of the information, product features, availability, functionality, or suitability of its products for any particular purpose, nor does **onsemi** assume any liability arising out of the application or use of any product or circuit, and specifically disclaims any and all liability, including without limitation special, consequential or incidental damages. Buyer is responsible for its products and applications using **onsemi** products, including compliance with all laws, regulations and safety requirements or standards, regardless of any support or applications information provided by **onsemi**. "Typical" parameters which may be provided in **onsemi** data sheets and/or specifications can and do vary in different applications and actual performance may vary over time. All operating parameters, including "Typicals" must be validated for each customer application by customer's technical experts. **onsemi** does not convey any license under any of its intellectual property rights nor the rights of others. **onsemi** products are not designed, intended, or authorized for use as a critical component in life support systems or any FDA Class 3 medical devices or medical devices with a same or similar classification in a foreign jurisdiction or any devices intended for implantation in the human body. Should Buyer purchase or use **onsemi** products for any such unintended or unauthorized application, Buyer shall indemnify and hold **onsemi** and its officers, employees, subsidiaries, affiliates, and distributors harmless against all claims, costs, damages, and expenses, and reasonable attorney fees arising out of, directly or indirectly, any claim of personal injury or death associated with such unintended or unauthorized use, even if such claim alleges that **onsemi** was negligent regarding the design or manufacture of the part. **onsemi** is an Equal Opportunity/Affirmative Action Employer. This literature is subject to all applicable copyright laws and is not for resale in any manner.

## PUBLICATION ORDERING INFORMATION

### LITERATURE FULFILLMENT:

Email Requests to: [orderlit@onsemi.com](mailto:orderlit@onsemi.com)

**onsemi Website:** [www.onsemi.com](http://www.onsemi.com)

### TECHNICAL SUPPORT

**North American Technical Support:**

Voice Mail: 1 800-282-9855 Toll Free USA/Canada

Phone: 011 421 33 790 2910

**Europe, Middle East and Africa Technical Support:**

Phone: 00421 33 790 2910

For additional information, please contact your local Sales Representative