

NIF5002N

Preferred Device

Self-Protected FET with Temperature and Current Limit

42 V, 2.0 A, Single N-Channel, SOT-223

HDPlus™ devices are an advanced series of power MOSFETs which utilize ON Semiconductors latest MOSFET technology process to achieve the lowest possible on-resistance per silicon area while incorporating smart features. Integrated thermal and current limits work together to provide short circuit protection. The devices feature an integrated Drain-to-Gate Clamp that enables them to withstand high energy in the avalanche mode. The Clamp also provides additional safety margin against unexpected voltage transients. Electrostatic Discharge (ESD) protection is provided by an integrated Gate-to-Source Clamp.

Features

- Current Limitation
- Thermal Shutdown with Automatic Restart
- Short Circuit Protection
- I_{DSS} Specified at Elevated Temperature
- Avalanche Energy Specified
- Slew Rate Control for Low Noise Switching
- Overvoltage Clamped Protection
- Pb-Free Packages are Available

Applications

- Lighting
- Solenoids
- Small Motors

MAXIMUM RATINGS (T_J = 25°C unless otherwise noted)

Rating	Symbol	Value	Unit
Drain-to-Source Voltage Internally Clamped	V _{DSS}	42	V
Drain-to-Gate Voltage Internally Clamped (R _G = 1.0 MΩ)	V _{DGR}	42	V
Gate-to-Source Voltage	V _{GS}	±14	V
Continuous Drain Current	I _D	Internally Limited	
Power Dissipation	P _D	@ T _A = 25°C (Note 1)	1.1
		@ T _A = 25°C (Note 2)	1.7
		@ T _T = 25°C (Note 3)	8.9
Operating Junction and Storage Temperature	T _J , T _{stg}	-55 to 150	°C
Single Pulse Drain-to-Source Avalanche Energy (V _{DD} = 32 V, V _G = 5.0 V, I _{PK} = 1.0 A, L = 300 mH, R _{G(ext)} = 25 Ω)	E _{AS}	150	mJ

Stresses exceeding Maximum Ratings may damage the device. Maximum Ratings are stress ratings only. Functional operation above the Recommended Operating Conditions is not implied. Extended exposure to stresses above the Recommended Operating Conditions may affect device reliability.



ON Semiconductor®

<http://onsemi.com>

V _{(BR)DSS (Clamped)}	R _{DS(ON) TYP}	I _{D MAX}
42 V	165 mΩ @ 10 V	2.0 A*

*Max current limit value is dependent on input condition.

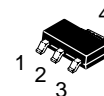
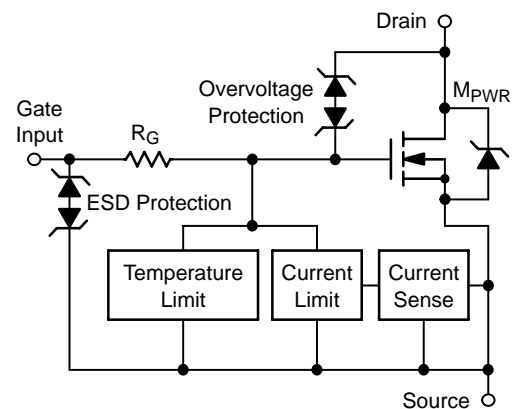

SOT-223
CASE 318E
STYLE 3

MARKING DIAGRAM

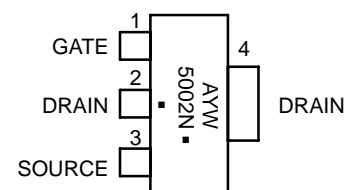

A = Assembly Location
Y = Year
W = Work Week
5002N = Specific Device Code
▪ = Pb-Free Package
(Note: Microdot may be in either location)

ORDERING INFORMATION

See detailed ordering and shipping information in the package dimensions section on page 4 of this data sheet.

Preferred devices are recommended choices for future use and best overall value.

NIF5002N

THERMAL CHARACTERISTICS

Characteristic	Symbol	Value	Unit
Junction-to-Ambient – Steady State (Note 1)	$R_{\theta JA}$	114	$^{\circ}\text{C}/\text{W}$
Junction-to-Ambient – Steady State (Note 2)	$R_{\theta JA}$	72	
Junction-to-Tab – Steady State (Note 3)	$R_{\theta JT}$	14	

1. Surface-mounted onto min pad FR4 PCB, (2 oz. Cu, 0.06" thick).
2. Surface-mounted onto 2" sq. FR4 board (1" sq., 1 oz. Cu, 0.06" thick).
3. Surface-mounted onto min pad FR4 PCB, (2 oz. Cu, 0.06" thick).

ELECTRICAL CHARACTERISTICS ($T_J = 25^{\circ}\text{C}$ unless otherwise noted)

Parameter	Symbol	Test Condition	Min	Typ	Max	Unit
-----------	--------	----------------	-----	-----	-----	------

OFF CHARACTERISTICS

Drain-to-Source Breakdown Voltage (Note 4)	$V_{(BR)DSS}$	$V_{GS} = 0\text{ V}, I_D = 10\text{ mA}$	$T_J = 25^{\circ}\text{C}$	42	46	55	V
			$T_J = 150^{\circ}\text{C}$	40	45	55	
Zero Gate Voltage Drain Current	I_{DSS}	$V_{GS} = 0\text{ V}, V_{DS} = 32\text{ V}$	$T_J = 25^{\circ}\text{C}$		0.25	4.0	μA
			$T_J = 150^{\circ}\text{C}$		1.1	20	
Gate Input Current	I_{GSSF}	$V_{DS} = 0\text{ V}, V_{GS} = 5.0\text{ V}$		50	100	μA	

ON CHARACTERISTICS (Note 4)

Gate Threshold Voltage	$V_{GS(th)}$	$V_{GS} = V_{DS}, I_D = 150\text{ }\mu\text{A}$	1.3	1.8	2.2	V	
Gate Threshold Temperature Coefficient	$V_{GS(th)}/T_J$			4.0	6.0	$-\text{mV}/^{\circ}\text{C}$	
Static Drain-to-Source On-Resistance	$R_{DS(on)}$	$V_{GS} = 10\text{ V}, I_D = 1.7\text{ A}$	$T_J = 25^{\circ}\text{C}$		165	200	$\text{m}\Omega$
			$T_J = 150^{\circ}\text{C}$		305	400	
		$V_{GS} = 5.0\text{ V}, I_D = 1.7\text{ A}$	$T_J = 25^{\circ}\text{C}$		195	230	
			$T_J = 150^{\circ}\text{C}$		360	460	
		$V_{GS} = 5.0\text{ V}, I_D = 0.5\text{ A}$	$T_J = 25^{\circ}\text{C}$		190	230	
			$T_J = 150^{\circ}\text{C}$		350	460	
Source-Drain Forward On Voltage	V_{SD}	$V_{GS} = 0\text{ V}, I_S = 7.0\text{ A}$		1.0		V	

SWITCHING CHARACTERISTICS

Turn-on Time	$t_{d(on)}$	$V_{GS} = 10\text{ V}, V_{DD} = 12\text{ V}, I_D = 2.5\text{ A}, R_L = 4.7\text{ }\Omega, (10\% V_{in} \text{ to } 90\% I_D)$		20	30	μs
Turn-off Time	$t_{d(off)}$			65	100	
Slew Rate On	dV_{DS}/dt_{on}	$R_L = 4.7\text{ }\Omega, V_{in} = 0 \text{ to } 10\text{ V}, V_{DD} = 12\text{ V}, 70\% \text{ to } 50\%$		1.2		$\text{V}/\mu\text{s}$
Slew-Rate Off	dV_{DS}/dt_{off}	$R_L = 4.7\text{ }\Omega, V_{in} = 0 \text{ to } 10\text{ V}, V_{DD} = 12\text{ V}, 50\% \text{ to } 70\%$		0.5		

SELF PROTECTION CHARACTERISTICS ($T_J = 25^{\circ}\text{C}$ unless otherwise noted) (Note 5)

Current Limit	I_{LIM}	$V_{DS} = 10\text{ V}, V_{GS} = 5.0\text{ V}$	$T_J = 25^{\circ}\text{C}$	3.1	4.7	6.3	A
			$T_J = 150^{\circ}\text{C}$	2.0	3.2	4.3	
		$V_{DS} = 10\text{ V}, V_{GS} = 10\text{ V}$	$T_J = 25^{\circ}\text{C}$	3.8	5.7	7.6	
			$T_J = 150^{\circ}\text{C}$	2.8	4.3	5.7	
Temperature Limit (Turn-off)	$T_{LIM(off)}$	$V_{GS} = 5.0\text{ V}$	150	175	200	$^{\circ}\text{C}$	
Temperature Limit (Circuit Reset)	$T_{LIM(on)}$	$V_{GS} = 5.0\text{ V}$	135	160	185		
Temperature Limit (Turn-off)	$T_{LIM(off)}$	$V_{GS} = 10\text{ V}$	150	165	185		
Temperature Limit (Circuit Reset)	$T_{LIM(on)}$	$V_{GS} = 10\text{ V}$	135	150	170		

ESD ELECTRICAL CHARACTERISTICS ($T_J = 25^{\circ}\text{C}$ unless otherwise noted)

Electro-Static Discharge Capability	ESD	Human Body Model (HBM)	4000			V
		Machine Model (MM)	400			

4. Pulse Test: Pulse Width $\leq 300\text{ }\mu\text{s}$, Duty Cycle $\leq 2\%$.
5. Fault conditions are viewed as beyond the normal operating range of the part.

TYPICAL PERFORMANCE CURVES

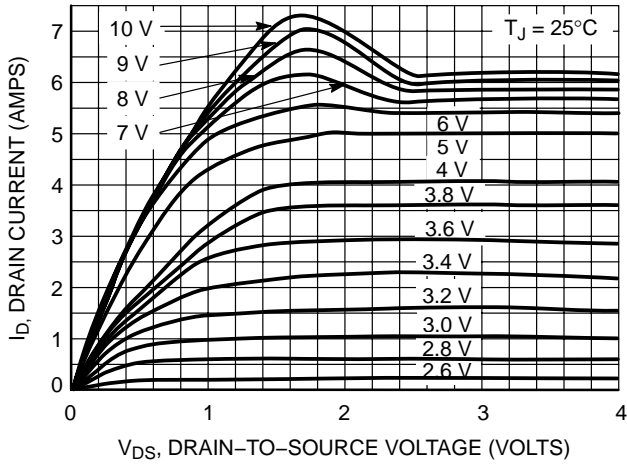

Figure 1. On-Region Characteristics

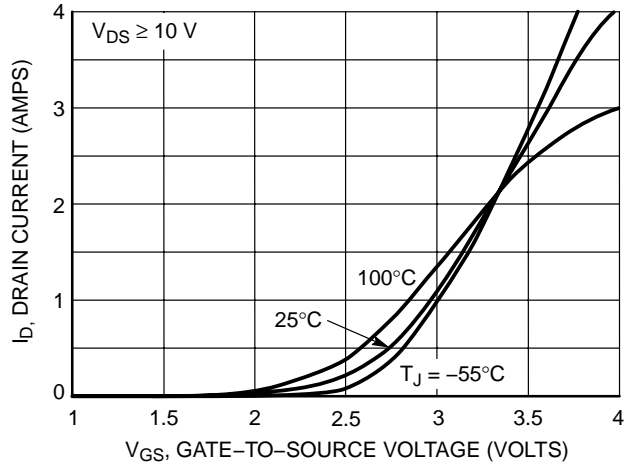

Figure 2. Transfer Characteristics

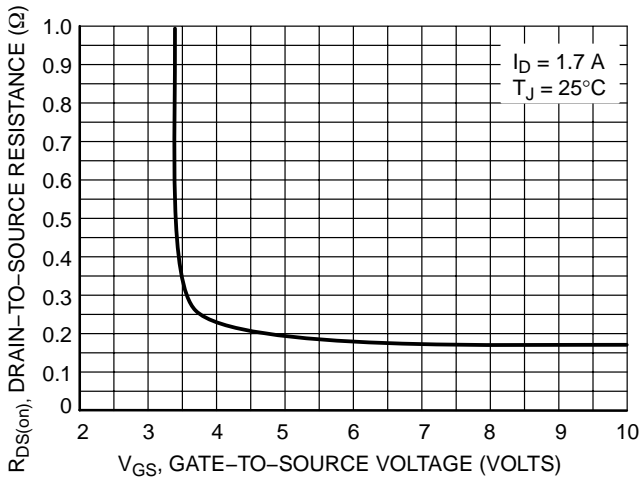

Figure 3. On-Resistance vs. Gate-to-Source Voltage

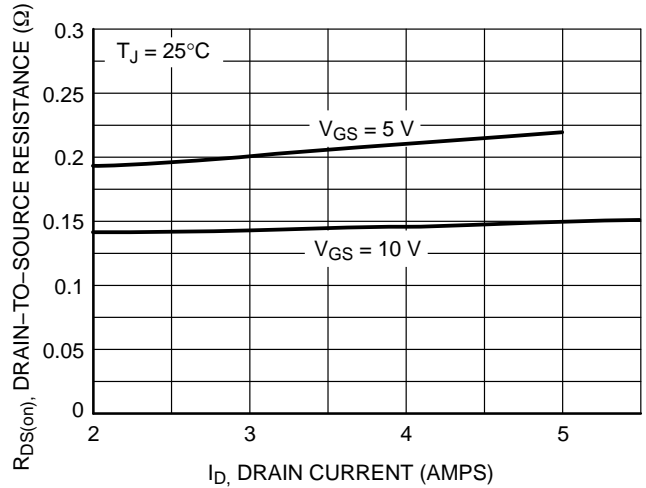

Figure 4. On-Resistance vs. Drain Current and Gate Voltage

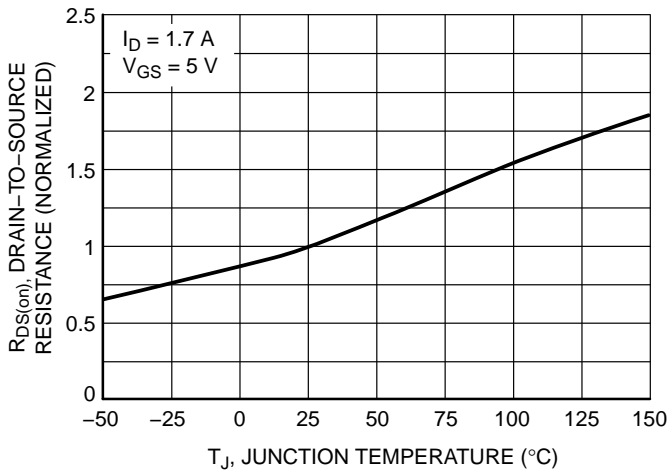

Figure 5. On-Resistance Variation with Temperature

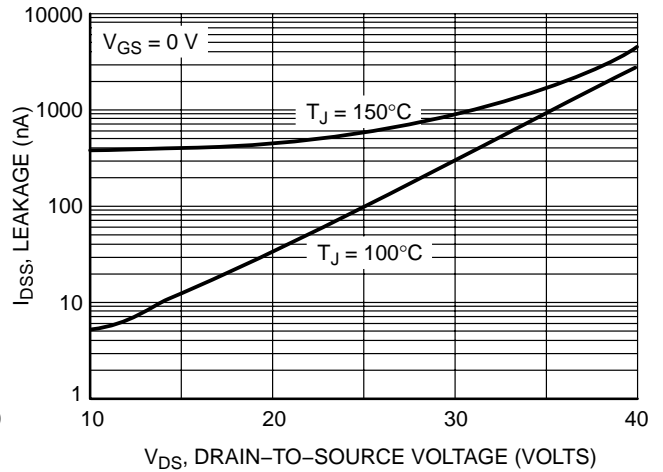

Figure 6. Drain-to-Source Leakage Current vs. Voltage

NIF5002N

TYPICAL PERFORMANCE CURVES

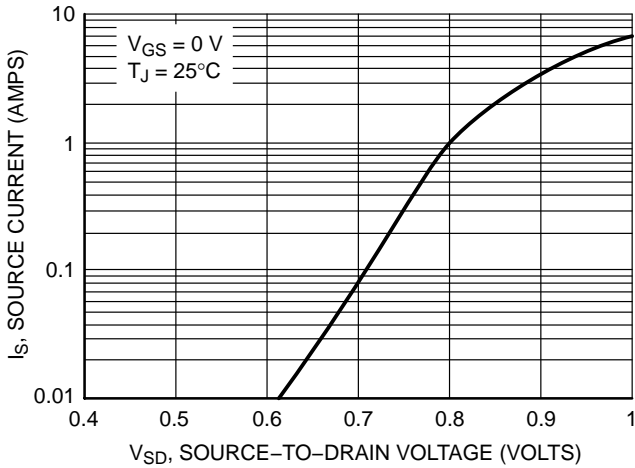

Figure 7. Diode Forward Voltage vs. Current

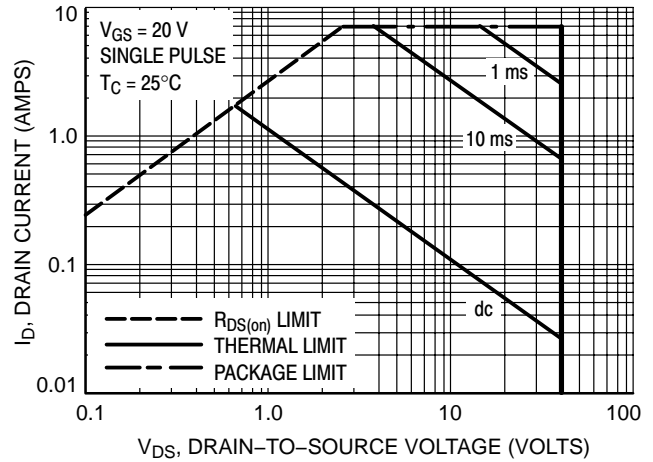

Figure 8. Maximum Rated Forward Biased Safe Operating Area

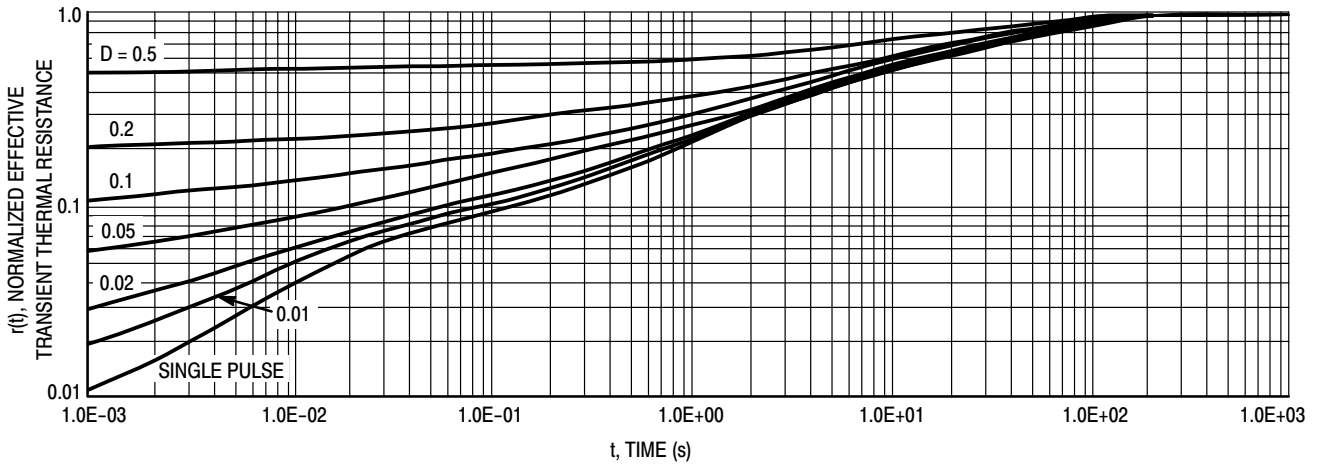

Figure 9. Thermal Response

ORDERING INFORMATION

Device	Package	Shipping†
NIF5002NT1	SOT-223	1000 / Tape & Reel
NIF5002NT1G	SOT-223 (Pb-Free)	1000 / Tape & Reel
NIF5002NT3	SOT-223	4000 / Tape & Reel
NIF5002NT3G	SOT-223 (Pb-Free)	4000 / Tape & Reel

†For information on tape and reel specifications, including part orientation and tape sizes, please refer to our Tape and Reel Packaging Specifications Brochure, BRD8011/D.

MECHANICAL CASE OUTLINE

PACKAGE DIMENSIONS

ON Semiconductor®



SCALE 1:1

SOT-223 (TO-261)
CASE 318E-04
ISSUE R

DATE 02 OCT 2018



NOTES:

1. DIMENSIONING AND TOLERANCING PER ASME Y14.5M, 1994.
2. CONTROLLING DIMENSION: MILLIMETERS
3. DIMENSIONS D & E DO NOT INCLUDE MOLD FLASH, PROTRUSIONS OR GATE BURRS. MOLD FLASH, PROTRUSIONS OR GATE BURRS SHALL NOT EXCEED 0.200MM PER SIDE.
4. DATUMS A AND B ARE DETERMINED AT DATUM H.
5. A1 IS DEFINED AS THE VERTICAL DISTANCE FROM THE SEATING PLANE TO THE LOWEST POINT OF THE PACKAGE BODY.
6. POSITIONAL TOLERANCE APPLIES TO DIMENSIONS b AND b1.

MILLIMETERS			
DIM	MIN.	NOM.	MAX.
A	1.50	1.63	1.75
A1	0.02	0.06	0.10
b	0.60	0.75	0.89
b1	2.90	3.06	3.20
c	0.24	0.29	0.35
D	6.30	6.50	6.70
E	3.30	3.50	3.70
e	2.30 BSC		
L	0.20	---	---
L1	1.50	1.75	2.00
He	6.70	7.00	7.30
θ	0°	---	10°



DOCUMENT NUMBER:	98ASB42680B	Electronic versions are uncontrolled except when accessed directly from the Document Repository. Printed versions are uncontrolled except when stamped "CONTROLLED COPY" in red.
DESCRIPTION:	SOT-223 (TO-261)	PAGE 1 OF 2

ON Semiconductor and are trademarks of Semiconductor Components Industries, LLC dba ON Semiconductor or its subsidiaries in the United States and/or other countries. ON Semiconductor reserves the right to make changes without further notice to any products herein. ON Semiconductor makes no warranty, representation or guarantee regarding the suitability of its products for any particular purpose, nor does ON Semiconductor assume any liability arising out of the application or use of any product or circuit, and specifically disclaims any and all liability, including without limitation special, consequential or incidental damages. ON Semiconductor does not convey any license under its patent rights nor the rights of others.

SOT-223 (TO-261)
CASE 318E-04
ISSUE R

DATE 02 OCT 2018

- | | | | | |
|--|---|---|---|---|
| STYLE 1:
PIN 1. BASE
2. COLLECTOR
3. EMITTER
4. COLLECTOR | STYLE 2:
PIN 1. ANODE
2. CATHODE
3. NC
4. CATHODE | STYLE 3:
PIN 1. GATE
2. DRAIN
3. SOURCE
4. DRAIN | STYLE 4:
PIN 1. SOURCE
2. DRAIN
3. GATE
4. DRAIN | STYLE 5:
PIN 1. DRAIN
2. GATE
3. SOURCE
4. GATE |
| STYLE 6:
PIN 1. RETURN
2. INPUT
3. OUTPUT
4. INPUT | STYLE 7:
PIN 1. ANODE 1
2. CATHODE
3. ANODE 2
4. CATHODE | STYLE 8:
CANCELLED | STYLE 9:
PIN 1. INPUT
2. GROUND
3. LOGIC
4. GROUND | STYLE 10:
PIN 1. CATHODE
2. ANODE
3. GATE
4. ANODE |
| STYLE 11:
PIN 1. MT 1
2. MT 2
3. GATE
4. MT 2 | STYLE 12:
PIN 1. INPUT
2. OUTPUT
3. NC
4. OUTPUT | STYLE 13:
PIN 1. GATE
2. COLLECTOR
3. EMITTER
4. COLLECTOR | | |

**GENERIC
 MARKING DIAGRAM***

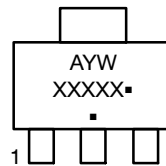

- A = Assembly Location
- Y = Year
- W = Work Week
- XXXXX = Specific Device Code
- = Pb-Free Package

(Note: Microdot may be in either location)

*This information is generic. Please refer to device data sheet for actual part marking. Pb-Free indicator, "G" or microdot "▪", may or may not be present. Some products may not follow the Generic Marking.

DOCUMENT NUMBER:	98ASB42680B	Electronic versions are uncontrolled except when accessed directly from the Document Repository. Printed versions are uncontrolled except when stamped "CONTROLLED COPY" in red.
DESCRIPTION:	SOT-223 (TO-261)	PAGE 2 OF 2

ON Semiconductor and are trademarks of Semiconductor Components Industries, LLC dba ON Semiconductor or its subsidiaries in the United States and/or other countries. ON Semiconductor reserves the right to make changes without further notice to any products herein. ON Semiconductor makes no warranty, representation or guarantee regarding the suitability of its products for any particular purpose, nor does ON Semiconductor assume any liability arising out of the application or use of any product or circuit, and specifically disclaims any and all liability, including without limitation special, consequential or incidental damages. ON Semiconductor does not convey any license under its patent rights nor the rights of others.

onsemi, **Onsemi**, and other names, marks, and brands are registered and/or common law trademarks of Semiconductor Components Industries, LLC dba "**onsemi**" or its affiliates and/or subsidiaries in the United States and/or other countries. **onsemi** owns the rights to a number of patents, trademarks, copyrights, trade secrets, and other intellectual property. A listing of **onsemi**'s product/patent coverage may be accessed at www.onsemi.com/site/pdf/Patent-Marking.pdf. **onsemi** reserves the right to make changes at any time to any products or information herein, without notice. The information herein is provided "as-is" and **onsemi** makes no warranty, representation or guarantee regarding the accuracy of the information, product features, availability, functionality, or suitability of its products for any particular purpose, nor does **onsemi** assume any liability arising out of the application or use of any product or circuit, and specifically disclaims any and all liability, including without limitation special, consequential or incidental damages. Buyer is responsible for its products and applications using **onsemi** products, including compliance with all laws, regulations and safety requirements or standards, regardless of any support or applications information provided by **onsemi**. "Typical" parameters which may be provided in **onsemi** data sheets and/or specifications can and do vary in different applications and actual performance may vary over time. All operating parameters, including "Typicals" must be validated for each customer application by customer's technical experts. **onsemi** does not convey any license under any of its intellectual property rights nor the rights of others. **onsemi** products are not designed, intended, or authorized for use as a critical component in life support systems or any FDA Class 3 medical devices or medical devices with a same or similar classification in a foreign jurisdiction or any devices intended for implantation in the human body. Should Buyer purchase or use **onsemi** products for any such unintended or unauthorized application, Buyer shall indemnify and hold **onsemi** and its officers, employees, subsidiaries, affiliates, and distributors harmless against all claims, costs, damages, and expenses, and reasonable attorney fees arising out of, directly or indirectly, any claim of personal injury or death associated with such unintended or unauthorized use, even if such claim alleges that **onsemi** was negligent regarding the design or manufacture of the part. **onsemi** is an Equal Opportunity/Affirmative Action Employer. This literature is subject to all applicable copyright laws and is not for resale in any manner.

PUBLICATION ORDERING INFORMATION

LITERATURE FULFILLMENT:

Email Requests to: orderlit@onsemi.com

onsemi Website: www.onsemi.com

TECHNICAL SUPPORT

North American Technical Support:
Voice Mail: 1 800-282-9855 Toll Free USA/Canada
Phone: 011 421 33 790 2910

Europe, Middle East and Africa Technical Support:

Phone: 00421 33 790 2910

For additional information, please contact your local Sales Representative